

Clean Code in Python

Refactor your legacy code base



Packt

www.packt.com

By Mariano Anaya

Clean Code in Python

Refactor your legacy code base

Mariano Anaya



BIRMINGHAM - MUMBAI

Clean Code in Python

Copyright © 2018 Packt Publishing

All rights reserved. No part of this book may be reproduced, stored in a retrieval system, or transmitted in any form or by any means, without the prior written permission of the publisher, except in the case of brief quotations embedded in critical articles or reviews.

Every effort has been made in the preparation of this book to ensure the accuracy of the information presented. However, the information contained in this book is sold without warranty, either express or implied. Neither the author, nor Packt Publishing or its dealers and distributors, will be held liable for any damages caused or alleged to have been caused directly or indirectly by this book.

Packt Publishing has endeavored to provide trademark information about all of the companies and products mentioned in this book by the appropriate use of capitals. However, Packt Publishing cannot guarantee the accuracy of this information.

Commissioning Editor: Merint Mathew
Acquisition Editor: Denim Pinto
Content Development Editor: Priyanka Sawant
Technical Editor: Gaurav Gala
Copy Editor: Safis Editing
Project Coordinator: Vaidehi Sawant
Proofreader: Safis Editing
Indexer: Rekha Nair
Graphics: Jason Monteiro
Production Coordinator: Shantanu Zagade

First published: August 2018

Production reference: 1270818

Published by Packt Publishing Ltd.
Livery Place
35 Livery Street
Birmingham
B3 2PB, UK.

ISBN 978-1-78883-583-1

www.packtpub.com



GET

80%

OFF ANY PACKT
EBOOK AND VIDEO



Go to www.packtpub.com
and use this code in the checkout:

HBBI80OFF

Packt

To my family and friends, for their unconditional love and support.

– Mariano Anaya



mapt.io

Mapt is an online digital library that gives you full access to over 5,000 books and videos, as well as industry leading tools to help you plan your personal development and advance your career. For more information, please visit our website.

Why subscribe?

- Spend less time learning and more time coding with practical eBooks and Videos from over 4,000 industry professionals
- Improve your learning with Skill Plans built especially for you
- Get a free eBook or video every month
- Mapt is fully searchable
- Copy and paste, print, and bookmark content

PacktPub.com

Did you know that Packt offers eBook versions of every book published, with PDF and ePub files available? You can upgrade to the eBook version at www.PacktPub.com and as a print book customer, you are entitled to a discount on the eBook copy. Get in touch with us at service@packtpub.com for more details.

At www.PacktPub.com, you can also read a collection of free technical articles, sign up for a range of free newsletters, and receive exclusive discounts and offers on Packt books and eBooks.

Contributors

About the author

Mariano Anaya is a software engineer who spends most of his time creating software with Python and mentoring fellow programmers. Mariano's main areas of interests besides Python are software architecture, functional programming, distributed systems, and speaking at conferences.

He was a speaker at Euro Python 2016 and 2017. To know more about him, you can refer to his GitHub account with the username `rmariano`.

His speakerdeck username is `rmariano`.

About the reviewer

Nimesh Kiran Verma has a dual degree in Maths and Computing from IIT Delhi and has worked with companies such as LinkedIn, Paytm and ICICI for about 5 years in software development and data science.

He co-founded a micro-lending company, Upwards Fintech and presently serves as its CTO. He loves coding and has mastery in Python and its popular frameworks, Django and Flask.

He extensively leverages Amazon Web Services, design patterns, SQL and NoSQL databases, to build reliable, scalable and low latency architectures.

To my mom, Nutan Kiran Verma, who made me what I am today and gave the confidence to pursue all my dreams. Thanks Papa, Naveen, and Prabhat, who motivated me to steal time for this book when in fact I was supposed to be spending it with them. Ulhas and the entire Packt team's support was tremendous. Thanks Varsha Shetty for introducing me to Packt.

Packt is searching for authors like you

If you're interested in becoming an author for Packt, please visit authors.packtpub.com and apply today. We have worked with thousands of developers and tech professionals, just like you, to help them share their insight with the global tech community. You can make a general application, apply for a specific hot topic that we are recruiting an author for, or submit your own idea.

Table of Contents

Preface	1
Chapter 1: Introduction, Code Formatting, and Tools	7
The meaning of clean code	8
The importance of having clean code	8
The role of code formatting in clean code	9
Adhering to a coding style guide on your project	10
Docstrings and annotations	12
Docstrings	13
Annotations	16
Do annotations replace docstrings?	18
Configuring the tools for enforcing basic quality gates	20
Type hinting with Mypy	20
Checking the code with Pylint	21
Setup for automatic checks	21
Summary	24
Chapter 2: Pythonic Code	25
Indexes and slices	26
Creating your own sequences	28
Context managers	29
Implementing context managers	32
Properties, attributes, and different types of methods for objects	35
Underscores in Python	35
Properties	38
Iterable objects	40
Creating iterable objects	40
Creating sequences	43
Container objects	45
Dynamic attributes for objects	46
Callable objects	48
Summary of magic methods	49
Caveats in Python	49
Mutable default arguments	50
Extending built-in types	51
Summary	53
References	53
Chapter 3: General Traits of Good Code	55
Design by contract	56

Preconditions	58
Postconditions	59
Pythonic contracts	59
Design by contract – conclusions	59
Defensive programming	60
Error handling	61
Value substitution	61
Exception handling	62
Handle exceptions at the right level of abstraction	64
Do not expose tracebacks	66
Avoid empty except blocks	67
Include the original exception	68
Using assertions in Python	69
Separation of concerns	70
Cohesion and coupling	71
Acronyms to live by	72
DRY/OAOC	72
YAGNI	74
KIS	74
EAFP/LBYL	76
Composition and inheritance	77
When inheritance is a good decision	78
Anti-patterns for inheritance	79
Multiple inheritance in Python	82
Method Resolution Order (MRO)	82
Mixins	84
Arguments in functions and methods	85
How function arguments work in Python	85
How arguments are copied to functions	86
Variable number of arguments	87
The number of arguments in functions	91
Function arguments and coupling	91
Compact function signatures that take too many arguments	92
Final remarks on good practices for software design	93
Orthogonality in software	94
Structuring the code	95
Summary	96
References	97
Chapter 4: The SOLID Principles	99
Single responsibility principle	99
A class with too many responsibilities	100
Distributing responsibilities	102
The open/closed principle	103
Example of maintainability perils for not following the open/closed principle	103
Refactoring the events system for extensibility	105
Extending the events system	107

Final thoughts about the OCP	109
Liskov's substitution principle	110
Detecting LSP issues with tools	111
Detecting incorrect datatypes in method signatures with Mypy	111
Detecting incompatible signatures with Pylint	113
More subtle cases of LSP violations	113
Remarks on the LSP	116
Interface segregation	117
An interface that provides too much	118
The smaller the interface, the better	118
How small should an interface be?	119
Dependency inversion	119
A case of rigid dependencies	120
Inverting the dependencies	121
Summary	122
References	123
Chapter 5: Using Decorators to Improve Our Code	124
What are decorators in Python?	124
Decorate functions	126
Decorate classes	127
Other types of decorator	131
Passing arguments to decorators	131
Decorators with nested functions	132
Decorator objects	134
Good uses for decorators	135
Transforming parameters	135
Tracing code	136
Effective decorators – avoiding common mistakes	136
Preserving data about the original wrapped object	136
Dealing with side-effects in decorators	139
Incorrect handling of side-effects in a decorator	139
Requiring decorators with side-effects	141
Creating decorators that will always work	143
The DRY principle with decorators	146
Decorators and separation of concerns	147
Analyzing good decorators	149
Summary	150
References	151
Chapter 6: Getting More Out of Our Objects with Descriptors	152
A first look at descriptors	152
The machinery behind descriptors	153
Exploring each method of the descriptor protocol	156
__get__(self, instance, owner)	156
__set__(self, instance, value)	157

__delete__(self, instance)	159
__set_name__(self, owner, name)	161
Types of descriptors	163
Non-data descriptors	163
Data descriptors	165
Descriptors in action	168
An application of descriptors	168
A first attempt without using descriptors	168
The idiomatic implementation	169
Different forms of implementing descriptors	172
The issue of global shared state	172
Accessing the dictionary of the object	173
Using weak references	174
More considerations about descriptors	175
Reusing code	175
Avoiding class decorators	176
Analysis of descriptors	180
How Python uses descriptors internally	180
Functions and methods	180
Built-in decorators for methods	183
Slots	185
Implementing descriptors in decorators	185
Summary	186
References	187
Chapter 7: Using Generators	188
Technical requirements	188
Creating generators	189
A first look at generators	189
Generator expressions	192
Iterating idiomatically	193
Idioms for iteration	193
The next() function	195
Using a generator	196
Itertools	196
Simplifying code through iterators	197
Repeated iterations	198
Nested loops	198
The iterator pattern in Python	200
The interface for iteration	200
Sequence objects as iterables	201
Coroutines	203
The methods of the generator interface	204
close()	204
throw(ex_type[, ex_value[, ex_traceback]])	205
send(value)	206
More advanced coroutines	209
Returning values in coroutines	209

Delegating into smaller coroutines – the yield from syntax	210
The simplest use of yield from	211
Capturing the value returned by a sub-generator	212
Sending and receiving data to and from a sub-generator	213
Asynchronous programming	215
Summary	217
References	218
Chapter 8: Unit Testing and Refactoring	219
Design principles and unit testing	219
A note about other forms of automated testing	221
Unit testing and agile software development	222
Unit testing and software design	222
Defining the boundaries of what to test	225
Frameworks and tools for testing	226
Frameworks and libraries for unit testing	226
unittest	228
Parametrized tests	230
pytest	232
Basic test cases with pytest	233
Parametrized tests	234
Fixtures	235
Code coverage	236
Setting up rest coverage	236
Caveats of test coverage	237
Mock objects	238
A fair warning about patching and mocks	239
Using mock objects	239
Types of mocks	240
A use case for test doubles	241
Refactoring	243
Evolving our code	244
Production code isn't the only thing that evolves	246
More about unit testing	247
Property-based testing	248
Mutation testing	248
A brief introduction to test-driven development	251
Summary	252
References	252
Chapter 9: Common Design Patterns	253
Considerations for design patterns in Python	254
Design patterns in action	255
Creational patterns	256
Factories	256
Singleton and shared state (monostate)	257
Shared state	257
The borg pattern	260

Builder	262
Structural patterns	262
Adapter	263
Composite	264
Decorator	266
Facade	268
Behavioral patterns	269
Chain of responsibility	270
The template method	272
Command	273
State	274
The null object pattern	280
Final thoughts about design patterns	282
The influence of patterns over the design	282
Names in our models	283
Summary	284
References	285
Chapter 10: Clean Architecture	286
From clean code to clean architecture	286
Separation of concerns	287
Abstractions	288
Software components	290
Packages	290
Containers	293
Use case	295
The code	296
Domain models	296
Calling from the application	298
Adapters	300
The services	300
Analysis	304
The dependency flow	304
Limitations	305
Testability	305
Intention revealing	306
Summary	306
References	307
Summing it all up	307
Other Books You May Enjoy	308
Index	311

Preface

This is a book about software engineering principles applied to Python.

There are many books about software engineering, and many resources available with information about Python. The intersection of those two sets, though, is something that requires action, and that's the gap this book tries to bridge.

It would not be realistic to cover all possible topics about software engineering in a single book because the field is so wide that there are entire books dedicated to certain topics. This book focuses on the main practices or principles of software engineering that will help us write more maintainable code, and how to write it by taking advantage of the features of Python at the same time.

A word to the wise: there is no single solution to a software problem. It's usually about trade-offs. Each solution will have upsides and downsides, and some criteria must be followed to choose between them, accepting the costs and getting the benefits. There is usually no single best solution, but there are principles to be followed, and as long as we follow them we will be walking a much safer path. And that is what this book is about: inspiring the readers to follow principles and make the best choices, because even when facing difficulties, we will be much better off if we have followed good practices.

And, speaking of good practices, while some of the explanations follow established and proven principles, other parts are opinionated. But that doesn't mean it has to be done in that particular way only. The author does not claim to be any sort of authority on the matter of clean code, because such a title cannot possibly exist. The reader is encouraged to engage in critical thinking: take what works the best for your project, and feel free to disagree. Differences of opinions are encouraged as long as they yield an enlightening debate.

My intention behind this book is to share the joys of Python, and idioms I have learned from experience, in the hope that readers will find them useful to elevate their expertise with the language.

The book explains the topics through code examples. These examples assume the latest version of Python at the time of this writing is used, namely Python 3.7, although future versions should be compatible as well. There are no peculiarities in the code that bind it to any particular platform, therefore with a Python interpreter, the code examples can be tested on any operating system.

In most of the examples, with the goal of keeping the code as simple as possible, the implementations and their tests are written in plain Python using just the standard libraries. In some chapters, extra libraries were needed, and in order to run the examples of those cases, instructions have been provided along with the respective `requirements.txt` file.

Throughout this book we will discover all the features Python has to offer to make our code better, more readable, and easier to maintain. We do so not only by exploring the features of the language, but also by analyzing how software engineering practices can be applied in Python. The reader will notice that some of the reference implementations differ in Python, other principles or patterns change slightly, and others might not be even applicable all along. Understanding each case represents an opportunity to understand Python more deeply.

Who this book is for

This book is suitable for all software engineering practitioners who are interested in software design or learning more about Python. It is assumed that the reader is already familiar with the principles of object-oriented software design and has some experience writing code.

In terms of Python, the book is suitable for all levels. It's good for learning Python because it is organized in such a way that the content is in increasing order of complexity. The first chapters will cover the basics of Python, which is a good way to learn the main idioms, functions, and utilities available in the language. The idea is not just to solve some problems with Python, but to do so in an idiomatic way.

Experienced programmers will also benefit from the topics in this book, as some sections cover advanced topics in Python, such as decorators, descriptors, and an introduction to asynchronous programming. It will help the reader discover more about Python because some of the cases are analyzed from the internals of the language itself.

It is worth emphasizing the word *practitioners* in the first sentence of this section. This is a pragmatic book. Examples are limited to what the case of study requires, but are also intended to resemble the context of a real software project. It is not an academic book, and as such the definitions made, the remarks made, and the recommendations given are to be taken with caution. The reader is expected to examine these recommendations critically and pragmatically rather than dogmatically. After all, practicality beats purity.

What this book covers

Chapter 1, *Introduction, Code Formatting, and Tools*, is an introduction to the main tools you need to set up a development environment in Python. We cover the basics a Python developer is recommended to know to start working with the language, as well as some guidelines for maintaining readable code in the project, such as tools for static analysis, documentation, type checking, and code formatting.

Chapter 2, *Pythonic Code*, looks at the first idioms in Python, which we will continue to use in the following chapters. We cover the particular features of Python, how they should be used, and we start building knowledge around the idea that Pythonic code is in general much better quality code.

Chapter 3, *General Traits of Good Code*, reviews general principles of software engineering that focus on writing maintainable code. We explore the idea and apply the concepts with the tools in the language.

Chapter 4, *The SOLID Principles*, covers a set of design principles for object-oriented software design. This acronym is part of the language or jargon of software engineering, and we see how each one of them can be applied to Python. Arguably not all of them are entirely applicable due to the nature of the language.

Chapter 5, *Using Decorators to Improve Our Code*, looks at one of the greatest features of Python. After understanding how to create decorators (for functions and classes), we put them in action for reusing code, separating responsibilities, and creating more granular functions.

Chapter 6, *Getting More Out of Our Objects with Descriptors*, explores descriptors in Python, which take object-oriented design to a new level. While this is a feature more related to frameworks and tools, we can see how to improve the readability of our code with descriptors, and also reuse code.

Chapter 7, *Using Generators*, shows that generators are probably the best feature of Python. The fact that iteration is a core component of Python could make us think that it leads to a new programming paradigm. By using generators and iterators in general, we can think about the way we write our programs. With the lessons learned from generators, we go further and learn about coroutines in Python, and the basics of asynchronous programming.

Chapter 8, *Unit Testing and Refactoring*, discusses the importance of unit tests in any code base that claims to be maintainable. The chapter reviews the importance of unit tests, and we explore the main frameworks for this (`unittest` and `pytest`).

Chapter 9, *Common Design Patterns*, reviews how to implement the most common design patterns in Python, not from the point of view of solving a problem, but by examining how they solve problems by leveraging a better and more maintainable solution. The chapter mentions the peculiarities of Python that have made some of the design patterns invisible and takes a pragmatic approach to implement some of them.

Chapter 10, *Clean Architecture*, focuses on the idea that clean code is the base of a good architecture. All those details we mentioned in the first chapter, and everything else revisited along the way, will play a critical role in the entire design when the system is deployed.

To get the most out of this book

The reader should be familiarized with Python's syntax and have a valid Python interpreter installed, which can be downloaded from <https://www.python.org/downloads/>

It is recommended to follow the examples in the book and test the code locally. For this, it is highly recommended to create a virtual environment with Python 3.7 and run the code with this interpreter. Instructions to create a virtual environment can be found at <https://docs.python.org/3/tutorial/venv.html>.

Download the example code files

You can download the example code files for this book from your account at www.packtpub.com. If you purchased this book elsewhere, you can visit www.packtpub.com/support and register to have the files emailed directly to you.

You can download the code files by following these steps:

1. Log in or register at www.packtpub.com.
2. Select the **SUPPORT** tab.
3. Click on **Code Downloads & Errata**.
4. Enter the name of the book in the **Search** box and follow the onscreen instructions.

Once the file is downloaded, please make sure that you unzip or extract the folder using the latest version of:

- WinRAR/7-Zip for Windows
- Zipeg/iZip/UnRarX for Mac
- 7-Zip/PeaZip for Linux

The code bundle for the book is also hosted on GitHub at <https://github.com/PacktPublishing/Clean-Code-in-Python>. In case there's an update to the code, it will be updated on the existing GitHub repository.

We also have other code bundles from our rich catalog of books and videos available at <https://github.com/PacktPublishing/>. Check them out!

Conventions used

There are a number of text conventions used throughout this book.

CodeInText: Indicates code words in text, database table names, folder names, filenames, file extensions, pathnames, dummy URLs, user input, and Twitter handles. Here is an example: "Then, just running the `pylint` command is enough to check it in the code."

A block of code is set as follows:

```
class Point:
    def __init__(self, lat, long):
        self.lat = lat
        self.long = long
```

When we wish to draw your attention to a particular part of a code block, the relevant lines or items are set in bold:

```
setup(
    name="apptool",
    description="Description of the intention of the package",
    long_description=long_description,
```

Any command-line input or output is written as follows:

```
>>> locate.__annotations__
{'latitude': float, 'longitue': float, 'return': __main__.Point}
```

Bold: Indicates a new term, an important word, or words that you see onscreen. For example, words in menus or dialog boxes appear in the text like this. Here is an example: "Select **System info** from the **Administration** panel."



Warnings or important notes appear like this.



Tips and tricks appear like this.

Get in touch

Feedback from our readers is always welcome.

General feedback: Email feedback@packtpub.com and mention the book title in the subject of your message. If you have questions about any aspect of this book, please email us at questions@packtpub.com.

Errata: Although we have taken every care to ensure the accuracy of our content, mistakes do happen. If you have found a mistake in this book, we would be grateful if you would report this to us. Please visit www.packtpub.com/submit-errata, selecting your book, clicking on the Errata Submission Form link, and entering the details.

Piracy: If you come across any illegal copies of our works in any form on the Internet, we would be grateful if you would provide us with the location address or website name. Please contact us at copyright@packtpub.com with a link to the material.

If you are interested in becoming an author: If there is a topic that you have expertise in and you are interested in either writing or contributing to a book, please visit authors.packtpub.com.

Reviews

Please leave a review. Once you have read and used this book, why not leave a review on the site that you purchased it from? Potential readers can then see and use your unbiased opinion to make purchase decisions, we at Packt can understand what you think about our products, and our authors can see your feedback on their book. Thank you!

For more information about Packt, please visit packtpub.com.

1

Introduction, Code Formatting, and Tools

In this chapter, we will explore the first concepts related to clean code, starting with what it is and what it means. The main point of the chapter is to understand that clean code is not just a nice thing to have or a luxury in software projects. It's a necessity. Without quality code, the project will face the perils of failing due to an accumulated technical debt.

Along the same lines, but going into a bit more detail, are the concepts of formatting and documenting the code. This also might sound like a superfluous requirement or task, but again, we will discover that it plays a fundamental role in keeping the code base maintainable and workable.

We will analyze the importance of adopting a good coding guideline for this project. Realizing that maintaining the code align to the reference is a continuous task, and we will see how we can get help from automated tools that will ease our work. For this reason, we quickly discuss how to configure the main tools so that they automatically run on the project as part of the build.

After reading this chapter, you will have an idea of what clean code is, why it is important, why formatting and documenting the code are crucial tasks, and how to automate this process. From this, you should acquire the mindset for quickly organizing the structure of a new project, aiming for good code quality.

After reading this chapter, you will have learned the following:

- That clean code really means something far more important than formatting in software construction
- That even so, having a standard formatting is a key component to have in a software project, for the sake of its maintainability

- How to make the code self-documenting by using the features that Python provides
- How to configure tools to help arrange the layout of the code in a consistent way so that team members can focus on the essence of the problem

The meaning of clean code

There is no sole or strict definition of clean code. Moreover, there is probably no way of formally measuring clean code, so you cannot run a tool on a repository that could tell you how good, bad, or maintainable or not that code is. Sure, you can run tools such as checkers, linters, static analyzers, and so on. And those tools are of much help. They are necessary, but not sufficient. Clean code is not something a machine or script could tell (so far), but rather something that us, as professionals, can decide.

For decades of using the terms programming languages, we thought that they were languages to communicate our ideas to the machine, so it can run our programs. We were wrong. That's not the truth, but part of the truth. The real language behind programming languages is to communicate our ideas to other developers.

Here is where the true nature of clean code lies. It depends on other engineers to be able to read and maintain the code. Therefore, we, as professionals, are the only ones who can judge this. Think about it; as developers, we spend much more time reading code than actually writing it. Every time we want to make a change or add a new feature, we first have to read all the surroundings of the code we have to modify or extend. The language (Python), is what we use to communicate among ourselves.

So, instead of giving you a definition (or my definition) of clean code, I invite you to go through the book, read all about idiomatic Python, see the difference between good and bad code, identify traits of good code and good architecture, and then come up with your own definition. After reading this book, you will be able to judge and analyze code for yourself, and you will have a more clear understanding of clean code. You will know what it is and what it means, regardless of any definition given to you.

The importance of having clean code

There are a huge number of reasons why clean code is important. Most of them revolve around the ideas of maintainability, reducing technical debt, working effectively with agile development, and managing a successful project.

The first idea I would like to explore is in regards to agile development and continuous delivery. If we want our project to be able to successfully deliver features constantly at a steady and predictable pace, then having a good and maintainable code base is a must.

Imagine you are driving a car on a road toward a destination you want to reach at a certain point in time. You have to estimate your arrival time so that you can tell the person who is waiting for you. If the car works fine, and the road is flat and perfect, then I do not see why you would miss your estimation by a large margin. Now, if the road is broken and you have to step out to move rocks out of the way, or avoid cracks, stop to check the engine every few kilometers, and so on, then it is very unlikely that you will know for sure when are you going to arrive (or if you are). I think the analogy is clear; the road is the code. If you want to move at a steady, constant, and predictable pace, the code needs to be maintainable and readable. If it is not, every time product management asks for a new feature, you will have to stop to refactor and fix the technical debt.

Technical debt refers to the concept of problems in the software as a result of a compromise, and a bad decision being made. In a way, it's possible to think about technical debt in two ways. From the present to the past. What if the problems we are currently facing are the result of previously written bad code? From the present to the future—if we decide to take the shortcut now, instead of investing time in a proper solution, what problems are we creating for ourselves in the future?

The word *debt* is a good choice. It's a debt because the code will be harder to change in the future than it would be to change it now. That incurred cost is the interests of the debt. Incurring in technical debt means that tomorrow, the code will be harder and more expensive (it would be possible to even measure this) than today, and even more expensive the day after, and so on.

Every time the team cannot deliver something on time and has to stop to fix and refactor the code is paying the price of technical debt.

The worst thing about technical debt is that it represents a long-term and underlying problem. It is not something that raises a high alarm. Instead, it is a silent problem, scattered across all parts of the project, that one day, at one particular time, will wake up and become a show-stopper.

The role of code formatting in clean code

Is clean code about formatting and structuring the code, according to some standards (for example, PEP-8, or a custom standard defined by the project guidelines)? The short answer is no.

Clean code is something else that goes way beyond coding standards, formatting, linting tools, and other checks regarding the layout of the code. Clean code is about achieving quality software and building a system that is robust, maintainable, and avoiding technical debt. A piece of code or an entire software component could be 100% with PEP-8 (or any other guideline), and still not satisfy these requirements.

However, not paying attention to the structure of the code has some perils. For this reason, we will first analyze the problems with a bad code structure, how to address them, and then we will see how to configure and use tools for Python projects in order to automatically check and correct problems.

To sum this up, we can say that clean code has nothing to do with things like PEP-8 or coding styles. It goes way beyond that, and it means something more meaningful to the maintainability of the code and the quality of the software. However, as we will see, formatting the code correctly is important in order to work efficiently.

Adhering to a coding style guide on your project

A coding guideline is a bare minimum a project should have to be considered being developed under quality standards. In this section, we will explore the reasons behind this, so in the following sections, we can start looking at ways to enforce this automatically by the means of tools.

The first thing that comes to my mind when I try to find good traits in a code layout is consistency. I would expect the code to be consistently structured so that it is easier to read and follow. If the code is not correct or consistently structured, and everyone on the team is doing things in their own way, then we will end up with code that will require extra effort and concentration to be followed correctly. It will be error-prone, misleading, and bugs or subtleties might slip through easily.

We want to avoid that. What we want is exactly the opposite of that—code that we can read and understand as quickly as possible at a single glance.

If all members of the development team agree on a standardized way of structuring the code, the resulting code would look much more familiar. As a result of that, you will quickly identify patterns (more about this in a second), and with these patterns in mind, it will be much easier to understand things and detect errors. For example, when something is amiss, you will notice that somehow, there is something odd in the patterns you are used to seeing, which will catch your attention. You will take a closer look, and you will more than likely spot the mistake!

As it was stated in the classical book, *Code Complete*, an interesting analysis of this was done on the paper titled *Perceptions in Chess* (1973), where an experiment was conducted in order to identify how different people can understand or memorize different chess positions. The experiment was conducted on players of all levels (novices, intermediate, and chess masters), and with different chess positions on the board. They found out that when the position was random, the novices did as well as the chess masters; it was just a memorization exercise that anyone could do at reasonably the same level. When the positions followed a logical sequence that might occur in a real game (again, consistency, adhering to a pattern), then the chess masters performed exceedingly better than the rest.

Now imagine this same situation applied to software. We, as the software engineers experts in Python, are like the chess masters in the previous example. When the code is structured randomly, without following any logic, or adhering to any standard, then it would be as difficult for us to spot mistakes as a novice developer. On the other hand, if we are used to reading code in a structured fashion, and we have learned to quickly get the ideas from the code by following patterns, then we are at a considerable advantage.

In particular, for Python, the sort of coding style you should follow is PEP-8. You can extend it or adopt some of its parts to the particularities of the project you are working on (for example, the length of the line, the notes about strings, and so on). However, I do suggest that regardless of whether you are using just plain PEP-8 or extending it, you should really stick to it instead of trying to come up with another different standard from scratch.

The reason for this is that this document already takes into consideration many of the particularities of the syntax of Python (that would not normally apply for other languages), and it was created by core Python developers who actually contributed to the syntax of Python. For this reason, it is hard to think that the accuracy of PEP-8 can be otherwise matched, not to mention, improved.

In particular, PEP-8 has some characteristics that carry other nice improvements when dealing with code, such as following:

- **Grepability:** This is the ability to grep tokens inside the code; that is, to search in certain files (and in which part of those files) for the particular string we are looking for. One of the items introduced by this standard is something that differentiates the way of writing the assignment of values to variables, from the keyword arguments being passed to functions.

To see this better, let's use an example. Let's say we are debugging, and we need to find where the value to a parameter named `location` is being passed. We can run the following `grep` command, and the result will tell us the file and the line we are looking for:

```
$ grep -nr "location=" .  
./core.py:13: location=current_location,
```

Now, we want to know where this variable is being assigned this value, and the following command will also give us the information we are looking for:

```
$ grep -nr "location =" .  
./core.py:10: current_location = get_location()
```

PEP-8 establishes the convention that, when passing arguments by keyword to a function, we don't use spaces, but we do when we assign variables. For that reason, we can adapt our search criteria (no spaces around the `=` on the first search, and one space on the second) and be more efficient in our search. That is one of the advantages of following a convention.

- **Consistency:** If the code looks like a uniform format, the reading of it will be much easier. This is particularly important for onboarding, if you want to welcome new developers to your project, or even hire new (and probably less experienced) programmers on your team, and they need to become familiar with the code (which might even consist of several repositories). It will make their lives much easier if the code layout, documentation, naming convention, and such is identical across all files they open, in all repositories.
- **Code quality:** By looking at the code in a structured fashion, you will become more proficient at understanding it at a glance (again, like in *Perception in Chess*), and you will spot bugs and mistakes more easily. In addition to that, tools that check for the quality of the code will also hint at potential bugs. Static analysis of the code might help to reduce the ratio of bugs per line of code.

Docstrings and annotations

This section is about documenting the code in Python, from within the code. Good code is self-explanatory but is also well-documented. It is a good idea to explain what it is supposed to do (not how).

One important distinction; documenting the code is not the same as adding comments on it. Comments are bad, and they should be avoided. By documentation, we refer to the fact of explaining the data types, providing examples of them, and annotating the variables.

This is relevant in Python, because being dynamically typed, it might be easy to get lost on the values of variables or objects across functions and methods. For this reason, stating this information will make it easier for future readers of the code.

There is another reason that specifically relates to annotations. They can also help in running some automatic checks, such as type hinting, through tools such as Mypy. We will find that, in the end, adding annotations pays off.

Docstrings

In simple terms, we can say that docstrings are basically documentation embedded in the source code. A **docstring** is basically a literal string, placed somewhere in the code, with the intention of documenting that part of the logic.

Notice the emphasis on the word **documentation**. This subtlety is important because it's meant to represent explanation, not justification. Docstrings are not comments; they are documentation.

Having comments in the code is a bad practice for multiple reasons. First, comments represent our failure to express our ideas in the code. If we actually have to explain why or how we are doing something, then that code is probably not good enough. For starters, it fails to be self-explanatory. Second, it can be misleading. Worst than having to spend some time reading a complicated section is to read a comment on how it is supposed to work, and figuring out that the code actually does something different. People tend to forget to update comments when they change the code, so the comment next to the line that was just changed will be outdated, resulting in a dangerous misdirection.

Sometimes, on rare occasions, we cannot avoid having comments. Maybe there is an error on a third-party library that we have to circumvent. In those cases, placing a small but descriptive comment might be acceptable.

With docstrings, however, the story is different. Again, they do not represent comments, but the documentation of a particular component (a module, class, method, or function) in the code. Their use is not only accepted but also encouraged. It is a good practice to add docstrings whenever possible.

The reason why they are a good thing to have in the code (or maybe even required, depending on the standards of your project) is that Python is dynamically typed. This means that, for example, a function can take anything as the value for any of its parameters. Python will not enforce, nor check, anything like this. So, imagine that you find a function in the code that you know you will have to modify. You are even lucky enough that the function has a descriptive name, and that its parameters do as well. It might still not be quite clear what types you should pass to it. Even if this is the case, how are they expected to be used?

Here is where a good docstring might be of help. Documenting the expected input and output of a function is a good practice that will help the readers of that function understand how it is supposed to work.

Consider this good example from the standard library:

```
In [1]: dict.update??
Docstring:
D.update([E, ]**F) -> None. Update D from dict/iterable E and F.
If E is present and has a .keys() method, then does: for k in E: D[k] =
E[k]
If E is present and lacks a .keys() method, then does: for k, v in E: D[k]
= v
In either case, this is followed by: for k in F: D[k] = F[k]
Type: method_descriptor
```

Here, the docstring for the `update` method on dictionaries gives us useful information, and it is telling us that we can use it in different ways:

1. We can pass something with a `.keys()` method (for example, another dictionary), and it will update the original dictionary with the keys from the object passed per parameter:

```
>>> d = {}
>>> d.update({1: "one", 2: "two"})
>>> d
{1: 'one', 2: 'two'}
```

2. We can pass an iterable of pairs of keys and values, and we will unpack them to update:

```
>>> d.update([(3, "three"), (4, "four")])
>>> d
{1: 'one', 2: 'two', 3: 'three', 4: 'four'}
```

In any case, the dictionary will be updated with the rest of the keyword arguments passed to it.

This information is crucial for someone that has to learn and understand how a new function works, and how they can take advantage of it.

Notice that in the first example, we obtained the docstring of the function by using the double question mark on it (`dict.update??`). This is a feature of the IPython interactive interpreter. When this is called, it will print the docstring of the object you are expecting. Now, imagine that in the same way, we obtained help from this function of the standard library; how much easier could you make the lives of your readers (the users of your code), if you place docstrings on the functions you write so that others can understand their workings in the same way?

The docstring is not something separated or isolated from the code. It becomes part of the code, and you can access it. When an object has a docstring defined, this becomes part of it via its `__doc__` attribute:

```
>>> def my_function():
...     """Run some computation"""
...     return None
...
>>> my_function.__doc__
'Run some computation'
```

This means that it is even possible to access it at runtime and even generate or compile documentation from the source code. In fact, there are tools for that. If you run Sphinx, it will create the basic scaffold for the documentation of your project. With the `autodoc` extension (`sphinx.ext.autodoc`) in particular, the tool will take the docstrings from the code and place them in the pages that document the function.

Once you have the tools in place to build the documentation, make it public so that it becomes part of the project itself. For open source projects, you can use `read the docs`, which will generate the documentation automatically per branch or version (configurable). For companies or projects, you can have the same tools or configure these services on-premise, but regardless of this decision, the important part is that the documentation should be ready and available to all members of the team.

There is, unfortunately, one downside to docstrings, and it is that, as it happens with all documentation, it requires manual and constant maintenance. As the code changes, it will have to be updated. Another problem is that for docstrings to be really useful, they have to be detailed, which requires multiple lines.

Maintaining proper documentation is a software engineering challenge that we cannot escape from. It also makes sense to be like this. If you think about it, the reason for documentation to be manually written is because it is intended to be read by other humans. If it were automated, it would probably not be of much use. For the documentation to be of any value, everyone on the team must agree that it is something that requires manual intervention, hence the effort required. The key is to understand that software is not just about code. The documentation that comes with it is also part of the deliverable. Therefore, when someone is making a change on a function, it is equally important to also update the corresponding part of the documentation to the code that was just changed, regardless of whether its a wiki, a user manual, a README file, or several docstrings.

Annotations

PEP-3107 introduced the concept of annotations. The basic idea of them is to hint to the readers of the code about what to expect as values of arguments in functions. The use of the word **hint** is not casual; annotations enable type hinting, which we will discuss later on in this chapter, after the first introduction to annotations.

Annotations let you specify the expected type of some variables that have been defined. It is actually not only about the types, but any kind of metadata that can help you get a better idea of what that variable actually represents.

Consider the following example:

```
class Point:
    def __init__(self, lat, long):
        self.lat = lat
        self.long = long

def locate(latitude: float, longitude: float) -> Point:
    """Find an object in the map by its coordinates"""
```

Here, we use `float` to indicate the expected types of `latitude` and `longitude`. This is merely informative for the reader of the function so that they can get an idea of these expected types. Python will not check these types nor enforce them.

We can also specify the expected type of the returned value of the function. In this case, `Point` is a user-defined class, so it will mean that whatever is returned will be an instance of `Point`.

However, types or built-ins are not the only kind of thing we can use as annotations. Basically, everything that is valid in the scope of the current Python interpreter could be placed there. For example, a string explaining the intention of the variable, a callable to be used as a callback or validation function, and so on.

With the introduction of annotations, a new special attribute is also included, and it is `__annotations__`. This will give us access to a dictionary that maps the name of the annotations (as keys in the dictionary) with their corresponding values, which are those we have defined for them. In our example, this will look like the following:

```
>>> locate.__annotations__
{'latitude': float, 'longitue': float, 'return': __main__.Point}
```

We could use this to generate documentation, run validations, or enforce checks in our code if we think we have to.

Speaking of checking the code through annotations, this is when PEP-484 comes into play. This PEP specifies the basics of type hinting; the idea of checking the types of our functions via annotations. Just to be clear again, and quoting PEP-484 itself:

"Python will remain a dynamically typed language, and the authors have no desire to ever make type hints mandatory, even by convention."

The idea of type hinting is to have extra tools (independent from the interpreter) to check and assess the correct use of types throughout the code and to hint to the user in case any incompatibilities are detected. The tool that runs these checks, Mypy, is explained in more detail in a later section, where we will talk about using and configuring the tools for the project. For now, you can think of it as a sort of linter that will check the semantics of the types used on the code. This sometimes helps in finding bugs early on, when the tests and checks are run. For this reason, it is a good idea to configure Mypy on the project and use it at the same level as the rest of the tools for static analysis.

However, type hinting means more than just a tool for checking the types on the code. Starting with Python 3.5, the new typing module was introduced, and this significantly improved how we define the types and the annotations in our Python code.

The basic idea behind this is that now the semantics extend to more meaningful concepts, making it even easier for us (humans) to understand what the code means, or what is expected at a given point. For example, you could have a function that worked with lists or tuples in one of its parameters, and you would have put one of these two types as the annotation, or even a string explaining it. But with this module, it is possible to tell Python that it expects an iterable or a sequence. You can even identify the type or the values on it; for example, that it takes a sequence of integers.

There is one extra improvement made in regards to annotations at the time of writing this book, and that is that starting from Python 3.6, it is possible to annotate variables directly, not just function parameters and return types. This was introduced in PEP-526, and the idea is that you can declare the types of some variables defined without necessarily assigning a value to them, as shown in the following listing:

```
class Point:
    lat: float
    long: float

>>> Point.__annotations__
{'lat': <class 'float'>, 'long': <class 'float'>}
```

Do annotations replace docstrings?

This is a valid question, since on older versions of Python, long before annotations were introduced, the way of documenting the types of the parameters of functions or attributes was done by putting docstrings on them. There are even some conventions on formats on how to structure docstrings to include the basic information for a function, including types and meaning of each parameter, type, and meaning of the result, and possible exceptions that the function might raise.

Most of this has been addressed already in a more compact way by means of annotations, so one might wonder if it is really worth having docstrings as well. The answer is yes, and this is because they complement each other.

It is true that a part of the information previously contained on the docstring can now be moved to the annotations. But this should only leave more room for a better documentation on the docstring. In particular, for dynamic and nested data types, it is always a good idea to provide examples of the expected data so that we can get a better idea of what we are dealing with.

Consider the following example. Let's say we have a function that expects a dictionary to validate some data:

```
def data_from_response(response: dict) -> dict:
    if response["status"] != 200:
        raise ValueError
    return {"data": response["payload"]}
```

Here, we can see a function that takes a dictionary and returns another dictionary. Potentially, it can raise an exception if the value under the key "status" is not the expected one. However, we do not have much more information about it. For example, what does a correct instance of a `response` object look like? What would an instance of `result` look like? To answer both of these questions, it would be a good idea to document examples of the data that is expected to be passed in by a parameter and returned by this function.

Let's see if we can explain this better with the help of a docstring:

```
def data_from_response(response: dict) -> dict:
    """If the response is OK, return its payload.

    - response: A dict like::

        {
            "status": 200, # <int>
            "timestamp": "...", # ISO format string of the current
            date time
            "payload": { ... } # dict with the returned data
        }

    - Returns a dictionary like::

        {"data": { .. } }

    - Raises:
    - ValueError if the HTTP status is != 200
    """
    if response["status"] != 200:
        raise ValueError
    return {"data": response["payload"]}
```

Now, we have a better idea of what is expected to be received and returned by this function. The documentation serves as valuable input, not only for understanding and getting an idea of what is being passed around, but also as a valuable source for unit tests. We can derive data like this to use as input, and we know what would be the correct and incorrect values to use on the tests. Actually, the tests also work as actionable documentation for our code, but this will be explained in more detail.

The benefit is that now we know what the possible values of the keys are, as well as their types, and we have a more concrete interpretation of what the data looks like. The cost is that, as we mentioned earlier, it takes up a lot of lines, and it needs to be verbose and detailed to be effective.

Configuring the tools for enforcing basic quality gates

In this section, we will explore how to configure some basic tools and automatically run checks on the code, with the goal of leveraging part of the repetitive verification checks.

This is an important point: remember that code is for us, people, to understand, so only we can determine what is good or bad code. We should invest time in code reviews, thinking about what good code is, and how readable and understandable it is. When looking at the code written by a peer, you should ask such questions:

- Is this code easy to understand and follow for a fellow programmer?
- Does it speak in terms of the domain of the problem?
- Would a new person joining the team be able to understand it and work with it effectively?

As we saw previously, code formatting, consistent layout, and proper indentation are required but not sufficient traits to have in a code base. Moreover, this is something that we, as engineers with a high sense of quality, would take for granted, so we would read and write code far beyond the basic concepts of its layout. Therefore, we are not willing to waste time reviewing these kinds of items, so we can invest our time more effectively by looking at actual patterns in the code in order to understand its true meaning and provide valuable results.

All of these checks should be automated. They should be part of the tests or checklist, and this, in turn, should be part of the continuous integration build. If these checks do not pass, make the build fail. This is the only way to actually ensure the continuity of the structure of the code at all times. It also serves as an objective parameter for the team to have as a reference. Instead of having some engineers or the leader of the team always having to tell the same comments about PEP-8 on code reviews, the build will automatically fail, making it something objective.

Type hinting with Mypy

Mypy (<http://mypy-lang.org/>) is the main tool for optional static type checking in Python. The idea is that, once you install it, it will analyze all of the files on your project, checking for inconsistencies on the use of the types. This is useful since, most of the time, it will detect actual bugs early, but sometimes it can give false positives.

You can install it with `pip`, and it is recommended to include it as a dependency for the project on the setup file:

```
$ pip install mypy
```

Once it is installed in the virtual environment, you just have to run the preceding command and it will report all of the findings on the type checks. Try to adhere to its report as much as possible, because most of the time, the insights provided by it help to avoid errors that might otherwise slip into production. However, the tool is not perfect, so if you think it is reporting a false positive, you can ignore that line with the following marker as a comment:

```
type_to_ignore = "something" # type: ignore
```

Checking the code with Pylint

There are many tools for checking the structure of the code (basically, this is compliance with PEP-8) in Python, such as `pycodestyle` (formerly known as PEP-8), `Flake8`, and many more. They all are configurable and are as easy to use as running the command they provide. Among all of them, I have found `Pylint` to be the most complete (and strict). It is also configurable.

Again, you just have to install it in the virtual environment with `pip`:

```
$ pip install pylint
```

Then, just running the `pylint` command would be enough to check it in the code.

It is possible to configure `Pylint` via a configuration file named `pylintrc`.

In this file, you can decide the rules you would like to enable or disable, and parametrize others (for example, to change the maximum length of the column).

Setup for automatic checks

On Unix development environments, the most common way of working is through `makefiles`. **Makefiles** are powerful tools that let us configure commands to be run in the project, mostly for compiling, running, and so on. Besides this, we can use a `makefile` in the root of our project, with some commands configured to run checks of the formatting and conventions on the code, automatically.

A good approach for this would be to have targets for the tests, and each particular test, and then have another one that will run altogether. For example:

```
typehint:
mypy src/ tests/

test:
pytest tests/

lint:
pylint src/ tests/

checklist: lint typehint test

.PHONY: typehint test lint checklist
```

Here, the command we should run (both in our development machines and in the continuous integration environment builds) is the following:

```
make checklist
```

This will run everything in the following steps:

1. It will first check the compliance with the coding guideline (PEP-8, for instance)
2. Then it will check for the use of types on the code
3. Finally, it will run the tests

If any of these steps fail, consider the entire process a failure.

Besides configuring these checks automatically in the build, it is also a good idea if the team adopts a convention and an automatic approach for structuring the code. Tools such as Black (<https://github.com/ambv/black>) automatically format the code. There are many tools that will edit the code automatically, but the interesting thing about Black is that it does so in a unique form. It's opinionated and deterministic, so the code will always end up arranged in the same way.

For example, Black strings will always be double-quotes, and the order of the parameters will always follow the same structure. This might sound rigid, but it's the only way to ensure the differences in the code are minimal. If the code always respects the same structure, changes in the code will only show up in pull requests with the actual changes that were made, and no extra cosmetic modifications. It's more restrictive than PEP-8, but it's also convenient because, by formatting the code directly through a tool, we don't have to actually worry about that, and we can focus on the crux of the problem at hand.

At the time of writing this book, the only thing that can be configured is the length of the lines. Everything else is corrected by the criteria of the project.

The following code is PEP-8 correct, but it doesn't follow the conventions of `black`:

```
def my_function(name):
    """
    >>> my_function('black')
    'received Black'
    """
    return 'received {}'.format(name.title())
```

Now, we can run the following command to format the file:

```
black -l 79 *.py
```

Now, we can see what the tool has written:

```
def my_function(name):
    """
    >>> my_function('black')
    'received Black'
    """
    return "received {}".format(name.title())
```

On more complex code, a lot more would have changed (trailing commas, and more), but the idea can be seen clearly. Again, it's opinionated, but it's also a good idea to have a tool that takes care of details for us. It's also something that the Golang community learned a long time ago, to the point that there is a standard tool library, `got fmt`, that automatically formats the code according to the conventions of the language. It's good that Python has something like this now.

These tools (Black, Pylint, Mypy, and many more) can be integrated with the editor or IDE of your choice to make things even easier. It's a good investment to configure your editor to make these kinds of modifications either when saving the file or through a shortcut.

Summary

We now have a first idea of what clean code is, and a workable interpretation of it, which will serve us as a reference point for the rest of this book.

More importantly, we understood that clean code is something much more important than the structure and layout of the code. We have to focus on how the ideas are represented on the code to see if they are correct. Clean code is about readability, maintainability of the code, keeping technical debt to the minimum, and effectively communicating our ideas into the code so that others can understand the same thing we intended to write in the first place.

However, we discussed that the adherence to coding styles or guidelines is important for multiple reasons. We have agreed that this is a condition that is necessary, but not sufficient, and since it is a minimal requirement every solid project should comply with, it is clear that is something we better leave to the tools. Therefore, automating all of these checks becomes critical, and in this regard, we have to keep in mind how to configure tools such as Mypy, Pylint, and more.

The next chapter is going to be more focused on the Python-specific code, and how to express our ideas in idiomatic Python. We will explore the idioms in Python that make for more compact and efficient code. In this analysis, we will see that, in general, Python has different ideas or different ways to accomplish things compared to other languages.

2

Pythonic Code

In this chapter, we will explore the way ideas are expressed in Python, with its own particularities. If you are familiar with the standard ways of accomplishing some tasks in programming (such as getting the last element of a list, iterating, searching, and so on), or if you come from more traditional programming languages (like C, C++, and Java), then you will find that, in general, Python provides its own mechanism for most common tasks.

In programming, an idiom is a particular way of writing code in order to perform a specific task. It is something common that repeats and follows the same structure every time. Some could even argue and call them a pattern, but be careful because they are not designed patterns (which we will explore later on). The main difference is that design patterns are high-level ideas, independent from the language (sort of), but they do not translate into code immediately. On the other hand, idioms are actually coded. It is the way things should be written when we want to perform a particular task.

As idioms are code, they are language dependent. Every language will have its own idioms, which means the way things are done in that particular language (for example, how you would open and write a file in C, C++, and so on). When the code follows these idioms, it is known as being idiomatic, which in Python is often referred to as **Pythonic**.

There are multiple reasons to follow these recommendations and write Pythonic code first (as we will see and analyze), writing code in an idiomatic way usually performs better. It is also more compact and easier to understand. These are traits that we always want in our code so that it works effectively. Secondly, as introduced in the previous chapter, it is important that the entire development team can get used to the same patterns and structure of the code because this will help them focus on the true essence of the problem, and will help them avoid making mistakes.

The goals of this chapter are as follows:

- To understand indices and slices, and correctly implement objects that can be indexed
- To implement sequences and other iterables
- To learn good use cases for context managers
- To implement more idiomatic code through magic methods
- To avoid common mistakes in Python that lead to undesired side-effects

Indexes and slices

In Python, as in other languages, some data structures or types support accessing its elements by index. Another thing it has in common with most programming languages is that the first element is placed in the index number zero. However, unlike those languages, when we want to access the elements in a different order than usual, Python provides extra features.

For example, how would you access the last element of an array in C? This is something I did the first time I tried Python. Thinking the same way as in C, I would get the element in the position of the length of the array minus one. This could work, but we could also use a negative index number, which will start counting from the last, as shown in the following commands:

```
>>> my_numbers = (4, 5, 3, 9)
>>> my_numbers[-1]
9
>>> my_numbers[-3]
5
```

In addition to getting just one element, we can obtain many by using `slice`, as shown in the following commands:

```
>>> my_numbers = (1, 1, 2, 3, 5, 8, 13, 21)
>>> my_numbers[2:5]
(2, 3, 5)
```

In this case, the syntax on the square brackets means that we get all of the elements on the tuple, starting from the index of the first number (inclusive), up to the index on the second one (not including it). Slices work this way in Python by excluding the end of the selected interval.

You can exclude either one of the intervals, start or stop, and in that case, it will act from the beginning or end of the sequence, respectively, as shown in the following commands:

```
>>> my_numbers[:3]
(1, 1, 2)
>>> my_numbers[3:]
(3, 5, 8, 13, 21)
>>> my_numbers[:]
(1, 1, 2, 3, 5, 8, 13, 21)
>>> my_numbers[1:7:2]
(1, 3, 8)
```

In the first example, it will get everything up to the index in the position number 3. In the second example, it will get all the numbers from the position 3 (inclusive), up to the end. In the second to last example, where both ends are excluded, it is actually creating a copy of the original tuple.

The last example includes a third parameter, which is the step. This indicates how many elements to jump when iterating over the interval. In this case, it would mean to get the elements between the positions one and seven, jumping by two.

In all of these cases, when we pass intervals to a sequence, what is actually happening is that we are passing `slice`. Note that `slice` is a built-in object in Python that you can build yourself and pass directly:

```
>>> interval = slice(1, 7, 2)
>>> my_numbers[interval]
(1, 3, 8)

>>> interval = slice(None, 3)
>>> my_numbers[interval] == my_numbers[:3]
True
```

Notice that when one of the elements is missing (start, stop, or step), it is considered to be `none`.



You should always prefer to use this built-in syntax for slices, as opposed to manually trying to iterate the tuple, string, or list inside a `for` loop, excluding the elements by hand.

Creating your own sequences

The functionality we just discussed works thanks to a magic method called `__getitem__`. This is the method that is called, when something like `myobject[key]` is called, passing the key (value inside the square brackets) as a parameter. A sequence, in particular, is an object that implements both `__getitem__` and `__len__`, and for this reason, it can be iterated over. Lists, tuples, and strings are examples of sequence objects in the standard library.

In this section, we care more about getting particular elements from an object by a key than building sequences or iterable objects, which is a topic explored in [Chapter 7, Using Generators](#).

If you are going to implement `__getitem__` in a custom class in your domain, you will have to take into account some considerations in order to follow a Pythonic approach.

In the case that your class is a wrapper around a standard library object, you might as well delegate the behavior as much as possible to the underlying object. This means that if your class is actually a wrapper on the list, call all of the same methods on that list to make sure that it remains compatible. In the following listing, we can see an example of how an object wraps a list, and for the methods we are interested in, we just delegate to its corresponding version on the `list` object:

```
class Items:
    def __init__(self, *values):
        self._values = list(values)

    def __len__(self):
        return len(self._values)

    def __getitem__(self, item):
        return self._values.__getitem__(item)
```

This example uses encapsulation. Another way of doing it is through inheritance, in which case we will have to extend the `collections.UserList` base class, with the considerations and caveats mentioned in the last part of this chapter.

If, however, you are implementing your own sequence, that is not a wrapper or does not rely on any built-in object underneath, then keep in mind the following points:

- When indexing by a range, the result should be an instance of the same type of the class
- In the range provided by the `slice`, respect the semantics that Python uses, excluding the element at the end

The first point is a subtle error. Think about it—when you get `slice` of a list, the result is a list; when you ask for a range in a tuple, the result is a tuple; and when you ask for a substring, the result is a string. It makes sense in each case that the result is of the same type of the original object. If you are creating, let's say, an object that represents an interval of dates, and you ask for a range on that interval, it would be a mistake to return a list or tuple, and many more. Instead, it should return a new instance of the same class with the new interval set. The best example of this is in the standard library, with the `range` function. Previously, in Python 2, the `range` function used to build a list. Now, if you call `range` with an interval, it will construct an iterable object that knows how to produce the values in the selected range. When you specify an interval for `range`, you get a new `range` (which makes sense), not a list:

```
>>> range(1, 100)[25:50]
range(26, 51)
```

The second rule is also about consistency—users of your code will find it more familiar and easier to use if it is consistent with Python itself. As Python developers, we are already used to the idea of how the slices work, how the `range` function works, and so on. Making an exception on a custom class will create confusion, which means that it will be harder to remember and it might lead to bugs.

Context managers

Context managers are a distinctively useful feature that Python provides. The reason why they are so useful is that they correctly respond to a pattern. The pattern is actually every situation where we want to run some code, and has preconditions and postconditions, meaning that we want to run things before and after a certain main action.

Most of the time, we see context managers around resource management. For example, on situations when we open files, we want to make sure that they are closed after processing (so we do not leak file descriptors), or if we open a connection to a service (or even a socket), we also want to be sure to close it accordingly, or when removing temporary files, and so on.

In all of these cases, you would normally have to remember to free all of the resources that were allocated and that is just thinking about the best case—but what about exceptions and error handling? Given the fact that handling all possible combinations and execution paths of our program makes it harder to debug, the most common way of addressing this issue is to put the cleanup code on a `finally` block so that we are sure we do not miss it. For example, a very simple case would look like the following:

```
fd = open(filename)
try:
    process_file(fd)
finally:
    fd.close()
```

Nonetheless, there is a much elegant and Pythonic way of achieving the same thing:

```
with open(filename) as fd:
    process_file(fd)
```

The `with` statement (PEP-343) enters the context manager. In this case, the `open` function implements the context manager protocol, which means that the file will be automatically closed when the block is finished, even if an exception occurred.

Context managers consist of two magic methods: `__enter__` and `__exit__`. On the first line of the context manager, the `with` statement will call the first method, `__enter__`, and whatever this method returns will be assigned to the variable labeled after `as`. This is optional—we don't really need to return anything specific on the `__enter__` method, and even if we do, there is still no strict reason to assign it to a variable if it is not required.

After this line is executed, the code enters a new context, where any other Python code can be run. After the last statement on that block is finished, the context will be exited, meaning that Python will call the `__exit__` method of the original context manager object we first invoked.

If there is an exception or error inside the context manager block, the `__exit__` method will still be called, which makes it convenient for safely managing cleaning up conditions. In fact, this method receives the exception that was triggered on the block in case we want to handle it in a custom fashion.

Despite the fact that context managers are very often found when dealing with resources (like the example we mentioned with files, connections, and so on), this is not the sole application they have. We can implement our own context managers in order to handle the particular logic we need.

Context managers are a good way of separating concerns and isolating parts of the code that should be kept independent, because if we mix them, then the logic will become harder to maintain.

As an example, consider a situation where we want to run a backup of our database with a script. The caveat is that the backup is offline, which means that we can only do it while the database is not running, and for this we have to stop it. After running the backup, we want to make sure that we start the process again, regardless of how the process of the backup itself went. Now, the first approach would be to create a huge monolithic function that tries to do everything in the same place, stop the service, perform the backup task, handle exceptions and all possible edge cases, and then try to restart the service again. You can imagine such a function, and for that reason, I will spare you the details, and instead come up directly with a possible way of tackling this issue with context managers:

```
def stop_database():
    run("systemctl stop postgresql.service")

def start_database():
    run("systemctl start postgresql.service")

class DBHandler:
    def __enter__(self):
        stop_database()
        return self

    def __exit__(self, exc_type, ex_value, ex_traceback):
        start_database()

def db_backup():
    run("pg_dump database")

def main():
    with DBHandler():
        db_backup()
```

In this example, we don't need the result of the context manager inside the block, and that's why we can consider that, at least for this particular case, the return value of `__enter__` is irrelevant. This is something to take into consideration when designing context managers—what do we need once the block is started? As a general rule, it should be good practice (although not mandatory), to always return something on the `__enter__`.

In this block, we only run the task for the backup, independently from the maintenance tasks, as we saw previously. We also mentioned that even if the backup task has an error, the `__exit__` will still be called.

Notice the signature of the `__exit__` method. It receives the values for the exception that was raised on the block. If there was no exception on the block, they are all none.

The return value of `__exit__` is something to consider. Normally, we would want to leave the method as it is, without returning anything in particular. If this method returns `True`, it means that the exception that was potentially raised; it will not propagate to the caller and will stop there. Sometimes, this is the desired effect, maybe even depending on the type of exception that was raised, but in general it is not a good idea to swallow the exception. Remember: errors should never pass silently.



Keep in mind not to accidentally return `True` on the `__exit__`. If you do, make sure that this is exactly what you want, and that there is a good reason for it.

Implementing context managers

In general, we can implement context managers like the one in the previous example. All we need is just a class that implements the `__enter__` and `__exit__` magic methods, and then that object will be able to support the context manager protocol. While this is the most common way for context managers to be implemented, it is not the only one.

In this section, we will see not only different (sometimes more compact) ways of implementing context managers but also how to take full advantage of them by using the standard library, in particular with the `contextlib` module.

The `contextlib` module contains a lot of helper functions and objects to either implement context managers or use some already provided ones that can help us write more compact code.

Let's start by looking at the `contextmanager` decorator.

When the `contextlib.contextmanager` decorator is applied to a function, it converts the code on that function into a context manager. The function in question has to be a particular kind of function called a **generator** function, which will separate the statements into what is going to be on the `__enter__` and `__exit__` magic methods, respectively.

If at this point you are not familiar with decorators and generators, this is not a problem because the examples we will be looking at will be self-contained, and the recipe or idiom can be applied and understood regardless. These topics are discussed in detail in Chapter 7, *Using Generators*.

The equivalent code of the previous example can be rewritten with the `contextmanager` decorator like this:

```
import contextlib

@contextlib.contextmanager
def db_handler():
    stop_database()
    yield
    start_database()

with db_handler():
    db_backup()
```

Here, we define the generator function and apply the `@contextlib.contextmanager` decorator to it. The function contains a `yield` statement, which makes it a generator function. Again, details on generators are not relevant in this case. All we need to know is that when this decorator is applied, everything before the `yield` statement will be run as if it were part of the `__enter__` method. Then, the yielded value is going to be the result of the context manager evaluation (what `__enter__` would return), and what would be assigned to the variable if we chose to assign it like `as x:`—in this case, nothing is yielded (which means the yielded value will be `None`, implicitly), but if we wanted to, we could yield a statement which will become something we might want to use inside the context manager block.

At that point, the generator function is suspended, and the context manager is entered, where, again, we run the backup code for our database. After this completes, the execution resumes, so we can consider that every line that comes after the `yield` statement will be part of the `__exit__` logic.

Writing context managers like this has the advantage that it is easier to refactor existing functions, reuse code, and in general is a good idea when we need a context manager that doesn't belong to any particular object. Adding the extra magic methods would make another object of our domain more coupled, with more responsibilities, and supporting something that it probably shouldn't. When we just need a context manager function, without preserving many states, and completely isolated and independent from the rest of our classes, this is probably a good way to go.

There are, however, more ways in which we can implement context manager, and once again, the answer is in the `contextlib` package from the standard library.

Another helper we could use is `contextlib.ContextDecorator`. This is a mixin base class that provides the logic for applying a decorator to a function that will make it run inside the context manager, while the logic for the context manager itself has to be provided by implementing the aforementioned magic methods.

In order to use it, we have to extend this class and implement the logic on the required methods:

```
class dbhandler_decorator(contextlib.ContextDecorator):
    def __enter__(self):
        stop_database()

    def __exit__(self, ext_type, ex_value, ex_traceback):
        start_database()

@dbhandler_decorator()
def offline_backup():
    run("pg_dump database")
```

Do you notice something different from the previous examples? There is no `with` statement. We just have to call the function, and `offline_backup()` will automatically run inside a context manager. This is the logic that the base class provides to use it as a decorator that wraps the original function so that it runs inside a context manager.

The only downside of this approach is that by the way the objects work, they are completely independent (which is a good trait)—the decorator doesn't know anything about the function that is decorating, and vice versa. This, however good, means that you cannot get an object that you would like to use inside the context manager (for example, assigning `with offline_backup() as bp:`), so if you really need to use the object returned by the `__exit__` method, one of the previous approaches will have to be the one of choice.

Being a decorator, this also poses the advantage that the logic is defined only once, and we can reuse it as many times as we want by simply applying the decorators to other functions that require the same invariant logic.

Let's explore one last feature of `contextlib`, to see what we can expect from context managers and get an idea of the sort of thing we could use them for.

Note that `contextlib.suppress` is a `util` package that enters a context manager, which, if one of the provided exceptions is raised, doesn't fail. It's similar to running that same code on a `try/except` block and passing an exception or logging it, but the difference is that calling the `suppress` method makes it more explicit that those exceptions that are controlled as part of our logic.

For example, consider the following code:

```
import contextlib

with contextlib.suppress(DataConversionException):
    parse_data(input_json_or_dict)
```

Here, the presence of the exception means that the input data is already in the expected format, so there is no need for conversion, hence making it safe to ignore it.

Properties, attributes, and different types of methods for objects

All of the properties and functions of an object are public in Python, which is different from other languages where properties can be public, private, or protected. That is, there is no point in preventing caller objects from invoking any attributes an object has. This is another difference with respect to other programming languages in which you can mark some attributes as private or protected.

There is no strict enforcement, but there are some conventions. An attribute that starts with an underscore is meant to be private to that object, and we expect that no external agent calls it (but again, there is nothing preventing this).

Before jumping into the details of properties, it's worth mentioning some traits of underscores in Python, understanding the convention, and the scope of attributes.

Underscores in Python

There are some conventions and implementation details that make use of underscores in Python, which is an interesting topic that's worthy of analysis.

Like we mentioned previously, by default all attributes of an object are public. Consider the following example to illustrate this:

```
>>> class Connector:
...     def __init__(self, source):
...         self.source = source
...         self._timeout = 60
...
>>> conn = Connector("postgresql://localhost")
>>> conn.source
'postgresql://localhost'
>>> conn._timeout
60
>>> conn.__dict__
{'source': 'postgresql://localhost', '_timeout': 60}
```

Here, a `Connector` object is created with `source`, and it starts with two attributes—the aforementioned `source` and `timeout`. The former is public, and the latter private. However, as we can see from the following lines when we create an object like this, we can actually access both of them.

The interpretation of this code is that `_timeout` should be accessed only within `connector` itself and never from a caller. This means that you should organize the code in a way so that you can safely refactor the `timeout` at all of the times it's needed, relying on the fact that it's not being called from outside the object (only internally), hence preserving the same interface as before. Complying with these rules makes the code easier to maintain and more robust because we don't have to worry about ripple effects when refactoring the code if we maintain the interface of the object. The same principle applies to methods as well.



Objects should only expose those attributes and methods that are relevant to an external caller object, namely, entailing its interface. Everything that is not strictly part of an object's interface should be kept prefixed with a single underscore.

This is the Pythonic way of clearly delimiting the interface of an object. There is, however, a common misconception that some attributes and methods can be actually made private. This is, again, a misconception. Let's imagine that now the `timeout` attribute is defined with a double underscore instead:

```
>>> class Connector:
...     def __init__(self, source):
...         self.source = source
...         self.__timeout = 60
...
...     def connect(self):
```

```
...         print("connecting with {0}s".format(self.__timeout))
...         # ...
...
>>> conn = Connector("postgresql://localhost")
>>> conn.connect()
connecting with 60s
>>> conn.__timeout
Traceback (most recent call last):
  File "<stdin>", line 1, in <module>
AttributeError: 'Connector' object has no attribute '__timeout'
```

Some developers use this method to hide some attributes, thinking, like in this example, that `timeout` is now `private` and that no other object can modify it. Now, take a look at the exception that is raised when trying to access `__timeout`. It's `AttributeError`, saying that it doesn't exist. It doesn't say something like "this is private" or "this can't be accessed" and so on. It says it does not exist. This should give us a clue that, in fact, something different is happening and that this behavior is instead just a side effect, but not the real effect we want.

What's actually happening is that with the double underscores, Python creates a different name for the attribute (this is called **name mangling**). What it does is create the attribute with the following name instead: "`__<class-name>__<attribute-name>`". In this case, an attribute named '`__Connector__timeout`', will be created, and such an attribute can be accessed (and modified) as follows:

```
>>> vars(conn)
{'source': 'postgresql://localhost', '__Connector__timeout': 60}
>>> conn.__Connector__timeout
60
>>> conn.__Connector__timeout = 30
>>> conn.connect()
connecting with 30s
```

Notice the side effect that we mentioned earlier—the attribute only exists with a different name, and for that reason the `AttributeError` was raised on our first attempt to access it.

The idea of the double underscore in Python is completely different. It was created as a means to override different methods of a class that is going to be extended several times, without the risk of having collisions with the method names. Even that is a too far-fetched use case as to justify the use of this mechanism.

Double underscores are a non-Pythonic approach. If you need to define attributes as private, use a single underscore, and respect the Pythonic convention that it is a private attribute.



Do not use double underscores.

Properties

When the object needs to just hold values, we can use regular attributes. Sometimes, we might want to do some computations based on the state of the object and the values of other attributes. Most of the time, properties are a good choice for this.

Properties are to be used when we need to define access control to some attributes in an object, which is another point where Python has its own way of doing things. In other programming languages (like Java), you would create access methods (getters and setters), but idiomatic Python would use properties instead.

Imagine that we have an application where users can register and we want to protect certain information about the user from being incorrect, such as their email, as shown in the following code:

```
import re

EMAIL_FORMAT = re.compile(r"^[^@]+@[^@]+\.[^@]+$")

def is_valid_email(potentially_valid_email: str):
    return re.match(EMAIL_FORMAT, potentially_valid_email) is not None

class User:
    def __init__(self, username):
        self.username = username
        self._email = None

    @property
    def email(self):
        return self._email

    @email.setter
    def email(self, new_email):
        if not is_valid_email(new_email):
            raise ValueError(f"Can't set {new_email} as it's not a
                valid email")
        self._email = new_email
```

By putting `email` under a property, we obtain some advantages for free. In this example, the first `@property` method will return the value held by the private attribute `email`. As mentioned earlier, the leading underscore determines that this attribute is intended to be used as private, and therefore should not be accessed from outside this class.

Then, the second method uses `@email.setter`, with the already defined property of the previous method. This is the one that is going to be called when `<user>.email = <new_email>` runs from the caller code, and `<new_email>` will become the parameter of this method. Here, we explicitly defined a validation that will fail if the value that is trying to be set is not an actual email address. If it is, it will then update the attribute with the new value as follows:

```
>>> u1 = User("jsmith")
>>> u1.email = "jsmith@"
Traceback (most recent call last):
...
ValueError: Can't set jsmith@ as it's not a valid email
>>> u1.email = "jsmith@g.co"
>>> u1.email
'jsmith@g.co'
```

This approach is much more compact than having custom methods prefixed with `get_` or `set_`. It's clear what is expected because it's just `email`.



Don't write custom `get_*` and `set_*` methods for all attributes on your objects. Most of the time, leaving them as regular attributes is just enough. If you need to modify the logic for when an attribute is retrieved or modified, then use properties.

You might find that properties are a good way to achieve command and query separation (CC08). Command and query separation state that a method of an object should either answer to something or do something, but not both. If a method of an object is doing something and at the same time it returns a status answering a question of how that operation went, then it's doing more than one thing, clearly violating the principle that functions should do one thing, and one thing only.

Depending on the name of the method, this can create even more confusion, making it harder for readers to understand what the actual intention of the code is. For example, if a method is called `set_email`, and we use it as `if self.set_email("a@j.com"): ...`, what is that code doing? Is it setting the email to `a@j.com`? Is it checking if the email is already set to that value? Both (setting and then checking if the status is correct)?

With properties, we can avoid this kind of confusion. The `@property` decorator is the query that will answer to something, and the `@<property_name>.setter` is the command that will do something.

Another piece of good advice derived from this example is as follows—don't do more than one thing on a method. If you want to assign something and then check the value, break that down into two or more sentences.



Methods should do one thing only. If you have to run an action and then check for the status, so that in separate methods that are called by different statements.

Iterable objects

In Python, we have objects that can be iterated by default. For example, lists, tuples, sets, and dictionaries can not only hold data in the structure we want but also be iterated over a `for` loop to get those values repeatedly.

However, the built-in iterable objects are not the only kind that we can have in a `for` loop. We could also create our own iterable, with the logic we define for iteration.

In order to achieve this, we rely on, once again, magic methods.

Iteration works in Python by its own protocol (namely the iteration protocol). When you try to iterate an object in the form `for e in myobject:...`, what Python checks at a very high level are the following two things, in order:

- If the object contains one of the iterator methods—`__next__` or `__iter__`
- If the object is a sequence and has `__len__` and `__getitem__`

Therefore, as a fallback mechanism, sequences can be iterated, and so there are two ways of customizing our objects to be able to work on `for` loops.

Creating iterable objects

When we try to iterate an object, Python will call the `iter()` function over it. One of the first things this function checks for is the presence of the `__iter__` method on that object, which, if present, will be executed.

The following code creates an object that allows iterating over a range of dates, producing one day at a time on every round of the loop:

```
from datetime import timedelta

class DateRangeIterable:
    """An iterable that contains its own iterator object."""

    def __init__(self, start_date, end_date):
        self.start_date = start_date
        self.end_date = end_date
        self._present_day = start_date

    def __iter__(self):
        return self

    def __next__(self):
        if self._present_day >= self.end_date:
            raise StopIteration
        today = self._present_day
        self._present_day += timedelta(days=1)
        return today
```

This object is designed to be created with a pair of dates, and when iterated, it will produce each day in the interval of specified dates, which is shown in the following code:

```
>>> for day in DateRangeIterable(date(2018, 1, 1), date(2018, 1, 5)):
...     print(day)
...
2018-01-01
2018-01-02
2018-01-03
2018-01-04
>>>
```

Here, the `for` loop is starting a new iteration over our object. At this point, Python will call the `iter()` function on it, which in turn will call the `__iter__` magic method. On this method, it is defined to return `self`, indicating that the object is an iterable itself, so at that point every step of the loop will call the `next()` function on that object, which delegates to the `__next__` method. In this method, we decide how to produce the elements and return one at a time. When there is nothing else to produce, we have to signal this to Python by raising the `StopIteration` exception.

This means that what is actually happening is similar to Python calling `next()` every time on our object until there is a `StopIteration` exception, on which it knows it has to stop the `for` loop:

```
>>> r = DateRangeIterable(date(2018, 1, 1), date(2018, 1, 5))
>>> next(r)
datetime.date(2018, 1, 1)
>>> next(r)
datetime.date(2018, 1, 2)
>>> next(r)
datetime.date(2018, 1, 3)
>>> next(r)
datetime.date(2018, 1, 4)
>>> next(r)
Traceback (most recent call last):
  File "<stdin>", line 1, in <module>
    File ... __next__
      raise StopIteration
StopIteration
>>>
```

This example works, but it has a small problem—once exhausted, the iterable will continue to be empty, hence raising `StopIteration`. This means that if we use this on two or more consecutive `for` loops, only the first one will work, while the second one will be empty:

```
>>> r1 = DateRangeIterable(date(2018, 1, 1), date(2018, 1, 5))
>>> ", ".join(map(str, r1))
'2018-01-01, 2018-01-02, 2018-01-03, 2018-01-04'
>>> max(r1)
Traceback (most recent call last):
  File "<stdin>", line 1, in <module>
ValueError: max() arg is an empty sequence
>>>
```

This is because of the way the iteration protocol works— an iterable constructs an iterator, and this one is the one being iterated over. In our example, `__iter__` just returned `self`, but we can make it create a new iterator every time it is called. One way of fixing this would be to create new instances of `DateRangeIterable`, which is not a terrible issue, but we can make `__iter__` use a generator (which are iterator objects), which is being created every time:

```
class DateRangeContainerIterable:
    def __init__(self, start_date, end_date):
        self.start_date = start_date
        self.end_date = end_date
```



```
def __iter__(self):
    current_day = self.start_date
    while current_day < self.end_date:
        yield current_day
        current_day += timedelta(days=1)
```

And this time, it works:

```
>>> r1 = DateRangeContainerIterable(date(2018, 1, 1), date(2018, 1, 5))
>>> ", ".join(map(str, r1))
'2018-01-01, 2018-01-02, 2018-01-03, 2018-01-04'
>>> max(r1)
datetime.date(2018, 1, 4)
>>>
```

The difference is that each `for` loop is calling `__iter__` again, and each one of those is creating the generator again.

This is called a **container** iterable.



In general, it is a good idea to work with container iterables when dealing with generators.

Details on generators will be explained in more detail in [Chapter 7, Using Generators](#).

Creating sequences

Maybe our object does not define the `__iter__()` method, but we still want to be able to iterate over it. If `__iter__` is not defined on the object, the `iter()` function will look for the presence of `__getitem__`, and if this is not found, it will raise `TypeError`.

A sequence is an object that implements `__len__` and `__getitem__` and expects to be able to get the elements it contains, one at a time, in order, starting at zero as the first index. This means that you should be careful in the logic so that you correctly implement `__getitem__` to expect this type of index, or the iteration will not work.

The example from the previous section had the advantage that it uses less memory. This means that it is only holding one date at a time, and knows how to produce the days one by one. However, it has the drawback that if we want to get the n^{th} element, we have no way to do so but iterate n -times until we reach it. This is a typical trade-off in computer science between memory and CPU usage.

The implementation with an iterable will use less memory, but it takes up to $O(n)$ to get an element, whereas implementing a sequence will use more memory (because we have to hold everything at once), but supports indexing in constant time, $O(1)$.

This is what the new implementation might look like:

```
class DateRangeSequence:
    def __init__(self, start_date, end_date):
        self.start_date = start_date
        self.end_date = end_date
        self._range = self._create_range()

    def _create_range(self):
        days = []
        current_day = self.start_date
        while current_day < self.end_date:
            days.append(current_day)
            current_day += timedelta(days=1)
        return days

    def __getitem__(self, day_no):
        return self._range[day_no]

    def __len__(self):
        return len(self._range)
```

Here is how the object behaves:

```
>>> s1 = DateRangeSequence(date(2018, 1, 1), date(2018, 1, 5))
>>> for day in s1:
...     print(day)
...
2018-01-01
2018-01-02
2018-01-03
2018-01-04
>>> s1[0]
datetime.date(2018, 1, 1)
>>> s1[3]
datetime.date(2018, 1, 4)
>>> s1[-1]
datetime.date(2018, 1, 4)
```

In the preceding code, we can see that negative indices also work. This is because the `DateRangeSequence` object delegates all of the operations to its wrapped object (a `list`), which is the best way to maintain compatibility and a consistent behavior.



Evaluate the trade-off between memory and CPU usage when deciding which one of the two possible implementations to use. In general, the iteration is preferable (and generators even more), but keep in mind the requirements of every case.

Container objects

Containers are objects that implement a `__contains__` method (that usually returns a Boolean value). This method is called in the presence of the `in` keyword of Python.

Something like the following:

```
element in container
```

When used in Python becomes this:

```
container.__contains__(element)
```

You can imagine how much more readable (and Pythonic!) the code can be when this method is properly implemented.

Let's say we have to mark some points on a map of a game that has two-dimensional coordinates. We might expect to find a function like the following:

```
def mark_coordinate(grid, coord):
    if 0 <= coord.x < grid.width and 0 <= coord.y < grid.height:
        grid[coord] = MARKED
```

Now, the part that checks the condition of the first `if` statement seems convoluted; it doesn't reveal the intention of the code, it's not expressive, and worst of all it calls for code duplication (every part of the code where we need to check the boundaries before proceeding will have to repeat that `if` statement).

What if the map itself (called `grid` on the code) could answer this question? Even better, what if the map could delegate this action to an even smaller (and hence more cohesive) object? Therefore, we can ask the map if it contains a coordinate, and the map itself can have information about its limit, and ask this object the following:

```
class Boundaries:
    def __init__(self, width, height):
        self.width = width
        self.height = height

    def __contains__(self, coord):
```

```
x, y = coord
return 0 <= x < self.width and 0 <= y < self.height

class Grid:
    def __init__(self, width, height):
        self.width = width
        self.height = height
        self.limits = Boundaries(width, height)

    def __contains__(self, coord):
        return coord in self.limits
```

This code alone is a much better implementation. First, it is doing a simple composition and it's using delegation to solve the problem. Both objects are really cohesive, having the minimal possible logic; the methods are short, and the logic speaks for itself—`coord in self.limits` is pretty much a declaration of the problem to solve, expressing the intention of the code.

From the outside, we can also see the benefits. It's almost as if Python is solving the problem for us:

```
def mark_coordinate(grid, coord):
    if coord in grid:
        grid[coord] = MARKED
```

Dynamic attributes for objects

It is possible to control the way attributes are obtained from objects by means of the `__getattr__` magic method. When we call something like `<myobject>.<myattribute>`, Python will look for `<myattribute>` in the dictionary of the object, calling `__getattr__` on it. If this is not found (namely, the object does not have the attribute we are looking for), then the extra method, `__getattr__`, is called, passing the name of the attribute (`myattribute`) as a parameter. By receiving this value, we can control the way things should be returned to our objects. We can even create new attributes, and so on.

In the following listing, the `__getattr__` method is demonstrated:

```
class DynamicAttributes:

    def __init__(self, attribute):
        self.attribute = attribute
```

```
def __getattr__(self, attr):
    if attr.startswith("fallback_"):
        name = attr.replace("fallback_", "")
        return f"[fallback resolved] {name}"
    raise AttributeError(
        f"{self.__class__.__name__} has no attribute {attr}"
    )
```

Here are some calls to an object of this class:

```
>>> dyn = DynamicAttributes("value")
>>> dyn.attribute
'value'

>>> dyn.fallback_test
'[fallback resolved] test'

>>> dyn.__dict__["fallback_new"] = "new value"
>>> dyn.fallback_new
'new value'

>>> getattr(dyn, "something", "default")
'default'
```

The first call is straightforward—we just request an attribute that the object has and get its value as a result. The second is where this method takes action because the object does not have anything called `fallback_test`, so the `__getattr__` will run with that value. Inside that method, we placed the code that returns a string, and what we get is the result of that transformation.

The third example is interesting because there a new attribute named `fallback_new` is created (actually, this call would be the same as running `dyn.fallback_new = "new value"`), so when we request that attribute, notice that the logic we put in `__getattr__` does not apply, simply because that code is never called.

Now, the last example is the most interesting one. There is a subtle detail here that makes a huge difference. Take another look at the code in the `__getattr__` method. Notice the exception it raises when the value is not retrievable `AttributeError`. This is not only for consistency (as well as the message in the exception) but also required by the built-in `getattr()` function. Had this exception been any other, it would raise, and the default value would not be returned.



Be careful when implementing a method so dynamic as `__getattr__`, and use it with caution. When implementing `__getattr__`, raise `AttributeError`.

Callable objects

It is possible (and often convenient) to define objects that can act as functions. One of the most common applications for this is to create better decorators, but it's not limited to that.

The magic method `__call__` will be called when we try to execute our object as if it were a regular function. Every argument passed to it will be passed along to the `__call__` method.

The main advantage of implementing functions this way, through objects, is that objects have states, so we can save and maintain information across calls.

When we have an object, a statement like `this object(*args, **kwargs)` is translated in Python to `object.__call__(*args, **kwargs)`.

This method is useful when we want to create callable objects that will work as parametrized functions, or in some cases functions with memory.

The following listing uses this method to construct an object that when called with a parameter returns the number of times it has been called with the very same value:

```
from collections import defaultdict

class CallCount:

    def __init__(self):
        self._counts = defaultdict(int)

    def __call__(self, argument):
        self._counts[argument] += 1
        return self._counts[argument]
```

Some examples of this class in action are as follows:

```
>>> cc = CallCount()
>>> cc(1)
1
>>> cc(2)
1
```

```
>>> cc(1)
2
>>> cc(1)
3
>>> cc("something")
1
```

Later in this book, we will find out that this method comes in handy when creating decorators.

Summary of magic methods

We can summarize the concepts we described in the previous sections in the form of a cheat sheet like the one presented as follows. For each action in Python, the magic method involved is presented, along with the concept that it represents:

Statement	Magic method	Python concept
obj[key] obj[i:j] obj[i:j:k]	<code>__getitem__(key)</code>	Subscriptable object
with obj: ...	<code>__enter__</code> / <code>__exit__</code>	Context manager
for i in obj: ...	<code>__iter__</code> / <code>__next__</code> <code>__len__</code> / <code>__getitem__</code>	Iterable object Sequence
obj.<attribute>	<code>__getattr__</code>	Dynamic attribute retrieval
obj(*args, **kwargs)	<code>__call__(*args, **kwargs)</code>	Callable object

Caveats in Python

Besides understanding the main features of the language, being able to write idiomatic code is also about being aware of the potential problems of some idioms, and how to avoid them. In this section, we will explore common issues that might cause you long debugging sessions if they catch you off guard.

Most of the points discussed in this section are things to avoid entirely, and I will dare to say that there is almost no possible scenario that justifies the presence of the anti-pattern (or idiom, in this case). Therefore, if you find this on the code base you are working on, feel free to refactor it in the way that is suggested. If you find these traits while doing a code review, this is a clear indication that something needs to change.

Mutable default arguments

Simply put, don't use mutable objects as the default arguments of functions. If you use mutable objects as default arguments, you will get results that are not the expected ones.

Consider the following erroneous function definition:

```
def wrong_user_display(user_metadata: dict = {"name": "John", "age": 30}):
    name = user_metadata.pop("name")
    age = user_metadata.pop("age")

    return f"{name} ({age})"
```

This has two problems, actually. Besides the default mutable argument, the body of the function is mutating a mutable object, hence creating a side effect. But the main problem is the default argument for `user_metadata`.

This will actually only work the first time it is called without arguments. For the second time, we call it without explicitly passing something to `user_metadata`. It will fail with a `KeyError`, like so:

```
>>> wrong_user_display()
'John (30)'
>>> wrong_user_display({"name": "Jane", "age": 25})
'Jane (25)'
>>> wrong_user_display()
Traceback (most recent call last):
  File "<stdin>", line 1, in <module>
  File ... in wrong_user_display
    name = user_metadata.pop("name")
KeyError: 'name'
```

The explanation is simple—by assigning the dictionary with the default data to `user_metadata` on the definition of the function, this dictionary is actually created once and the variable `user_metadata` points to it. The body of the function modifies this object, which remains alive in memory so long as the program is running. When we pass a value to it, this will take the place of the default argument we just created. When we don't want this object it is called again, and it has been modified since the previous run; the next time we run it, will not contain the keys since they were removed on the previous call.

The fix is also simple—we need to use `None` as a default sentinel value and assign the default on the body of the function. Because each function has its own scope and life cycle, `user_metadata` will be assigned to the dictionary every time `None` appears:

```
def user_display(user_metadata: dict = None):
    user_metadata = user_metadata or {"name": "John", "age": 30}

    name = user_metadata.pop("name")
    age = user_metadata.pop("age")

    return f"{name} ({age})"
```

Extending built-in types

The correct way of extending built-in types such as lists, strings, and dictionaries is by means of the `collections` module.

If you create a class that directly extends `dict`, for example, you will obtain results that are probably not what you are expecting. The reason for this is that in CPython the methods of the class don't call each other (as they should), so if you override one of them, this will not be reflected by the rest, resulting in unexpected outcomes. For example, you might want to override `__getitem__`, and then when you iterate the object with a `for` loop, you will notice that the logic you have put on that method is not applied.

This is all solved by using `collections.UserDict`, for example, which provides a transparent interface to actual dictionaries, and is more robust.

Let's say we want a list that was originally created from numbers to convert the values to strings, adding a prefix. The first approach might look like it solves the problem, but it is erroneous:

```
class BadList(list):
    def __getitem__(self, index):
        value = super().__getitem__(index)
        if index % 2 == 0:
            prefix = "even"
        else:
            prefix = "odd"
        return f"[{prefix}] {value}"
```

At first sight, it looks like the object behaves as we want it to. But then, if we try to iterate it (after all, it is a list), we find that we don't get what we wanted:

```
>>> bl = BadList((0, 1, 2, 3, 4, 5))
>>> bl[0]
'[even] 0'
>>> bl[1]
'[odd] 1'
>>> "".join(bl)
Traceback (most recent call last):
...
TypeError: sequence item 0: expected str instance, int found
```

The `join` function will try to iterate (run a `for` loop over) the list, but expects values of type string. This should work because it is exactly the type of change we made to the list, but apparently when the list is being iterated, our changed version of the `__getitem__` is not being called.

This issue is actually an implementation detail of CPython (a C optimization), and in other platforms such as PyPy it doesn't happen (see the differences between PyPy and CPython in the references at the end of this chapter).

Regardless of this, we should write code that is portable and compatible in all implementations, so we will fix it by extending not from `list` but from `UserList`:

```
from collections import UserList

class GoodList(UserList):
    def __getitem__(self, index):
        value = super().__getitem__(index)
        if index % 2 == 0:
            prefix = "even"
        else:
            prefix = "odd"
        return f"[{prefix}] {value}"
```

And now things look much better:

```
>>> gl = GoodList((0, 1, 2))
>>> gl[0]
'[even] 0'
>>> gl[1]
'[odd] 1'
>>> "; ".join(gl)
'[even] 0; [odd] 1; [even] 2'
```



Don't extend directly from `dict`, use `collections.UserDict` instead. For lists, use `collections.UserList`, and for strings, use `collections.UserString`.

Summary

In this chapter, we have explored the main features of Python, with the goal of understanding its most distinctive features, those that make Python a peculiar language compared to the rest. On this path, we have explored different methods of Python, protocols, and their internal mechanics.

As opposed to the previous chapter, this one is more Python-focused. A key takeaway of the topics of this book is that clean code goes beyond following the formatting rules (which, of course, are essential to a good code base). They are a necessary condition, but not sufficient. Over the next few chapters, we will see ideas and principles that relate more to the code, with the goal of achieving a better design and implementation of our software solution.

With the concepts and the ideas of this chapter, we explored the core of Python: its protocols and magic methods. It should be clear by now that the best way of having Pythonic, idiomatic code is not only by following the formatting conventions but also by taking full advantage of all the features Python has to offer. This means that you should sometimes use a particular magic method, implement a context manager, and more.

In the next chapter, we will put these concepts into action, relating general concepts of software engineering with the way they can be written in Python.

References

The reader will find more information about some of the topics that we have covered in this chapter in the following references. The decision of how indices work in Python is based on (EWD831), which analyzes several alternatives for ranges in math and programming languages:

- *EWD831*: Why numbering should start at zero (<https://www.cs.utexas.edu/users/EWD/transcriptions//EWD831.html>)
- *PEP-343*: The "with" Statement (<https://www.python.org/dev/peps/pep-0343/>)

- **CC08:** The book written by Robert C. Martin named *Clean Code: A Handbook of Agile Software Craftsmanship*
- **Python documentation, the `iter()` function** (<https://docs.python.org/3/library/functions.html#iter>)
- **Differences between PyPy and CPython** (https://pypy.readthedocs.io/en/latest/cpython_differences.html#subclasses-of-built-in-types)

3

General Traits of Good Code

This is a book about software construction with Python. Good software is built from a good design. By saying things such as clean code, one might think that we will explore good practices that relate only to the implementation details of the software, instead of its design. However, this assumption would be wrong since the code is not something different from the design—the code is the design.

The code is probably the most detailed representation of the design. In the first two chapters, we discussed why structuring the code in a consistent way was important, and we have seen idioms for writing more compact and idiomatic code. Now it's time to understand that clean code is that, and much more—the ultimate goal is to make the code as robust as possible, and to write it in a way that minimizes defects or makes them utterly evident, should they occur.

This chapter and the next one are focused on design principles at a higher level of abstraction. These ideas not only relate to Python in particular but are instead general principles of software engineering.

In particular, for this chapter, we will review different principles that make for good software design. Good-quality software should be built around these ideas, and they will serve as design tools. This does not mean that all of them should always be applied; in fact, some of them represent different points of view (such is the case with the **Design by Contract (DbC)** approach, as opposed to defensive programming). Some of them depend on the context and are not always applicable.

A high-quality code is a concept that has multiple dimensions. We can think of this similarly to how we think about the quality attributes of a software architecture. For example, we want our software to be secure and to have good performance, reliability, and maintainability, just to name a few.

The goals of this chapter are as follows:

- To understand the concepts behind robust software
- To learn how to deal with erroneous data during the workflow of the application
- To design maintainable software that can easily be extended and adapted to new requirements
- To design reusable software
- To write effective code that will keep the productivity of the development team high

Design by contract

Some parts of the software we are working on are not meant to be called directly by users, but instead by other parts of the code. Such is the case when we divide the responsibilities of the application into different components or layers, and we have to think about the interaction between them.

We will have to encapsulate some functionality behind each component, and expose an interface to clients who are going to use that functionality, namely an **Application Programming Interface (API)**. The functions, classes, or methods we write for that component have a particular way of working under certain considerations that, if they are not met, will make our code crash. Conversely, clients calling that code expect a particular response, and any failure of our function to provide this would represent a defect.

That is to say that if, for example, we have a function that is expected to work with a series of parameters of type integers, and some other function invokes our passing strings, it is clear that it should not work as expected, but in reality, the function should not run at all because it was called incorrectly (the client made a mistake). This error should not pass silently.

Of course, when designing an API, the expected input, output, and side-effects should be documented. But documentation cannot enforce the behavior of the software at runtime. These rules, what every part of the code expects in order to work properly and what the caller is expecting from them, should be part of the design, and here is where the concept of a **contract** comes into place.

The idea behind the DbC is that instead of implicitly placing in the code what every party is expecting, both parties agree on a contract that, if violated, will raise an exception, clearly stating why it cannot continue.

In our context, a contract is a construction that enforces some rules that must be honored during the communication of software components. A contract entails mainly preconditions and postconditions, but in some cases, invariants, and side-effects are also described:

- **Preconditions:** We can say that these are all the checks code will do before running. It will check for all the conditions that have to be made before the function can proceed. In general, it's implemented by validating the data set provided in the parameters passed, but nothing should stop us from running all sorts of validations (for example, validating a set in a database, a file, another method that was called before, and so on) if we consider that their side-effects are overshadowed by the importance of such a validation. Notice that this imposes a constraint on the caller.
- **Postconditions:** The opposite of preconditions, here, the validations are done after the function call is returned. Postcondition validations are run to validate what the caller is expecting from this component.
- **Invariants:** Optionally, it would be a good idea to document, in the docstring of a function, the invariants, the things that are kept constant while the code of the function is running, as an expression of the logic of the function to be correct.
- **Side-effects:** Optionally, we can mention any side-effects of our code in the docstring.

While conceptually all of these items form part of the contract for a software component, and this is what should go to the documentation of such piece, only the first two (preconditions and postconditions) are to be enforced at a low level (code).

The reason why we would design by contract is that if errors occur, they must be easy to spot (and by noticing whether it was either the precondition or postcondition that failed, we will find the culprit much easily) so that they can be quickly corrected. More importantly, we want critical parts of the code to avoid being executed under the wrong assumptions. This should help to clearly mark the limits for the responsibilities and errors if they occur, as opposed to something saying—this part of the application is failing... But the caller code provided the wrong arguments, so where should we apply the fix?

The idea is that preconditions bind the client (they have an obligation to meet them if they want to run some part of the code), whereas postconditions bind the component in question to some guarantees that the client can verify and enforce.

This way, we can quickly identify responsibilities. If the precondition fails, we know it is due to a defect on the client. On the other hand, if the postcondition check fails, we know the problem is in the routine or class (supplier) itself.

Specifically regarding preconditions, it is important to highlight that they can be checked at runtime, and if they occur, the code that is being called should not be run at all (it does not make sense to run it because its conditions do not hold, and further more, doing so might end up making things worse).

Preconditions

Preconditions are all of the guarantees a function or method expects to receive in order to work correctly. In general programming terms, this usually means to provide data that is properly formed, for example, objects that are initialized, non-null values, and many more. For Python, in particular, being dynamically typed, this also means that sometimes we need to check for the exact type of data that are provided. This is not exactly the same as type checking, the kind `mypy` would do this, but rather verify for exact values that are needed.

Part of these checks can be detected early on by using static analysis tools, such as `mypy`, which we already introduced in [Chapter 1, Introduction, Code Formatting, and Tools](#), but these checks are not enough. A function should have proper validation for the information that it is going to handle.

Now, this poses the question of where to place the validation logic, depending on whether we let the clients validate all the data before calling the function, or allow this one to validate everything that it received prior running its own logic. The former corresponds to a tolerant approach (because the function itself is still allowing any data, potentially malformed data as well), whereas the latter corresponds to a demanding approach.

For the purposes of this analysis, we prefer a demanding approach when it comes to DbC, because it is usually the safest choice in terms of robustness, and usually the most common practice in the industry.

Regardless of the approach we decide to take, we should always keep in mind the non-redundancy principle, which states that the enforcement of each precondition for a function should be done by only one of the two parts of the contract, but not both. This means that we put the validation logic on the client, or we leave it to the function itself, but in no cases should we duplicate it (which also relates to the DRY principle, which we will discuss later on in this chapter).

Postconditions

Postconditions are the part of the contract that is responsible for enforcing the state after the method or function has returned.

Assuming that the function or method has been called with the correct properties (that is, with its preconditions met), then the postconditions will guarantee that certain properties are preserved.

The idea is to use postconditions to check and validate for everything that a client might need. If the method executed properly, and the postcondition validations pass, then any client calling that code should be able to work with the returned object without problems, as the contract has been fulfilled.

Pythonic contracts

At the time of writing this book, a PEP-316, named Programming by Contract for Python, is deferred. This doesn't mean that we cannot implement it in Python, because, as introduced at the beginning of the chapter, this is a general design principle.

Probably the best way to enforce this is by adding control mechanisms to our methods, functions, and classes, and if they fail raise a `RuntimeError` exception or `ValueError`. It's hard to devise a general rule for the correct type of exception, as that would pretty much depend on the application in particular. These previously mentioned exceptions are the most common types of exception, but if they don't fit accurately with the problem, creating a custom exception would be the best choice.

We would also like to keep the code as isolated as possible. That is, the code for the preconditions in one part, the one for the postconditions in another, and the core of the function separated. We could achieve this separation by creating smaller functions, but in some cases implementing a decorator would be an interesting alternative.

Design by contract – conclusions

The main value of this design principle is to effectively identify where the problem is. By defining a contract, when something fails at runtime it will be clear what part of the code is broken, and what broke the contract.

As a result of following this principle, the code will be more robust. Each component is enforcing its own constraints and maintaining some invariants, and the program can be proven correct as long as these invariants are preserved.

It also serves the purpose of clarifying the structure of the program better. Instead of trying to run ad hoc validations, or trying to surmount all possible failure scenarios, the contracts explicitly specify what each function or method expects to work properly, and what is expected from them.

Of course, following these principles also adds extra work, because we are not just programming the core logic of our main application, but also the contracts. In addition, we might also want to consider adding unit tests for these contracts as well. However, the quality gained by this approach pays off in the long run; hence, it is a good idea to implement this principle for critical components of the application.

Nonetheless, for this method to be effective, we should carefully think about what are we willing to validate, and this has to be a meaningful value. For example, it would not make much sense to define contracts that only check for the correct data types of the parameters provided to a function. Many programmers would argue that this would be like trying to make Python a statically-typed language. Regardless of this, tools such as Mypy, in combination with the use of annotations, would serve this purpose much better and with less effort. With that in mind, design contracts so that there is actually value on them, checking, for example, the properties of the objects being passed and returned, the conditions they have to hold, and so on.

Defensive programming

Defensive programming follows a somewhat different approach than DbC; instead of stating all conditions that must be held in a contract, that if unmet will raise an exception and make the program fail, this is more about making all parts of the code (objects, functions, or methods) able to protect themselves against invalid inputs.

Defensive programming is a technique that has several aspects, and it is particularly useful if it is combined with other design principles (this means that the fact that it follows a different philosophy than DbC does not mean that it is a case of either one or the other—it could mean that they might complement each other).

The main ideas on the subject of defensive programming are how to handle errors for scenarios that we might expect to occur, and how to deal with errors that should never occur (when impossible conditions happen). The former will fall into error handling procedures, while the latter will be the case for assertions, both topics we will be exploring in the following sections.

Error handling

In our programs, we resort to error handling procedures for situations that we anticipate as prone to cause errors. This is usually the case for data input.

The idea behind error handling is to gracefully respond to these expected errors in an attempt to either continue our program execution or decide to fail if the error turns out to be insurmountable.

There are different approaches by which we can handle errors on our programs, but not all of them are always applicable. Some of these approaches are as follows:

- Value substitution
- Error logging
- Exception handling

Value substitution

In some scenarios, when there is an error and there is a risk of the software producing an incorrect value or failing entirely, we might be able to replace the result with another, safer value. We call this value substitution, since we are in fact replacing the actual erroneous result for a value that is to be considered non-disruptive (it could be a default, a well-known constant, a sentinel value, or simply something that does not affect the result at all, like returning zero in a case where the result is intended to be applied to a sum).

Value substitution is not always possible, however. This strategy has to be carefully chosen for cases where the substituted value is actually a safe option. Making this decision is a trade-off between robustness and correctness. A software program is robust when it does not fail, even in the presence of an erroneous scenario. But this is not correct either.

This might not be acceptable for some kinds of software. If the application is critical, or the data being handled is too sensitive, this is not an option, since we cannot afford to provide users (or other parts of the application) with erroneous results. In these cases, we opt for correctness, rather than let the program explode when yielding the wrong results.

A slightly different, and safer, version of this decision is to use default values for data that is not provided. This can be the case for parts of the code that can work with a default behavior, for example, default values for environment variables that are not set, for missing entries in configuration files, or for parameters of functions. We can find examples of Python supporting this throughout different methods of its API, for example, dictionaries have a `get` method, whose (optional) second parameter allows you to indicate a default value:

```
>>> configuration = {"dbport": 5432}
>>> configuration.get("dbhost", "localhost")
'localhost'
>>> configuration.get("dbport")
5432
```

Environment variables have a similar API:

```
>>> import os
>>> os.getenv("DBHOST")
'localhost'
>>> os.getenv("DPORT", 5432)
5432
```

In both previous examples, if the second parameter is not provided, `None` will be returned, because it's the default value those functions are defined with. We can also define default values for the parameters of our own functions:

```
>>> def connect_database(host="localhost", port=5432):
...     logger.info("connecting to database server at %s:%i", host, port)
```

In general, replacing missing parameters with default values is acceptable, but substituting erroneous data with legal close values is more dangerous and can mask some errors. Take this criterion into consideration when deciding on this approach.

Exception handling

In the presence of incorrect or missing input data, sometimes it is possible to correct the situation with some examples such as the ones mentioned in the previous section. In other cases, however, it is better to stop the program from continuing to run with the wrong data than to leave it computing under erroneous assumptions. In those cases, failing and notifying the caller that something is wrong is a good approach, and this is the case for a precondition that was violated, as we saw in DbC.

Nonetheless, erroneous input data is not the only possible way in which a function can go wrong. After all, functions are not just about passing data around; they also have side-effects and connect to external components.

It could be possible that a fault in a function call is due to a problem on one of these external components, and not in our function itself. If that is the case, our function should communicate this properly. This will make it easier to debug. The function should clearly, and unambiguously notify the rest of the application about errors that cannot be ignored so that they can be addressed accordingly.

The mechanism for accomplishing this is an exception. It is important to emphasize that this is what exceptions should be used for—clearly announcing an exceptional situation, not altering the flow of the program according to business logic.

If the code tries to use exceptions to handle expected scenarios or business logic, the flow of the program will become harder to read. This will lead to a situation where exceptions are used as a sort of `go-to` statement, that (to make things worse) could span multiple levels on the call stack (up to caller functions), violating the encapsulation of the logic into its correct level of abstraction. The case could get even worse if these `except` blocks are mixing business logic with truly exceptional cases that the code is trying to defend against; in that case, it will be harder to distinguish between the core logic we have to maintain and errors to be handled.



Do not use exceptions as a `go-to` mechanism for business logic. Raise exceptions when there is actually something wrong with the code that callers need to be aware of.

This last concept is an important one; exceptions are usually about notifying the caller about something that is amiss. This means that exceptions should be used carefully because they weaken encapsulation. The more exceptions a function has, the more the caller function will have to anticipate, therefore knowing about the function it is calling. And if a function raises too many exceptions, this means that is not so context-free, because every time we want to invoke it, we will have to keep all of its possible side-effects in mind.

This can be used as a heuristic to tell when a function is not cohesive enough and has too many responsibilities. If it raises too many exceptions, it could be a sign that it has to be broken down into multiple, smaller ones.

Here are some recommendations that relate to exceptions in Python.

Handle exceptions at the right level of abstraction

Exceptions are also part of the principal functions that do one thing, and one thing only. The exception the function is handling (or raising) has to be consistent with the logic encapsulated on it.

In this example, we can see what we mean by mixing different levels of abstractions. Imagine an object that acts as a transport for some data in our application. It connects to an external component where the data is going to be sent upon decoding. In the following listing, we will focus on the `deliver_event` method:

```
class DataTransport:
    """An example of an object handling exceptions of different levels."""

    retry_threshold: int = 5
    retry_n_times: int = 3

    def __init__(self, connector):
        self._connector = connector
        self.connection = None

    def deliver_event(self, event):
        try:
            self.connect()
            data = event.decode()
            self.send(data)
        except ConnectionError as e:
            logger.info("connection error detected: %s", e)
            raise
        except ValueError as e:
            logger.error("%r contains incorrect data: %s", event, e)
            raise

    def connect(self):
        for _ in range(self.retry_n_times):
            try:
                self.connection = self._connector.connect()
            except ConnectionError as e:
                logger.info(
                    "%s: attempting new connection in %is",
                    e,
                    self.retry_threshold,
                )
                time.sleep(self.retry_threshold)
            else:
                return self.connection
        raise ConnectionError(
```

```
        f"Couldn't connect after {self.retry_n_times} times"
    )

    def send(self, data):
        return self.connection.send(data)
```

For our analysis, let's zoom in and focus on how the `deliver_event()` method handles exceptions.

What does `ValueError` have to do with `ConnectionError`? Not much. By looking at these two highly different types of error, we can get an idea of how responsibilities should be divided. The `ConnectionError` should be handled inside the `connect` method. This will allow a clear separation of behavior. For example, if this method needs to support retries, that would be a way of doing it. Conversely, `ValueError` belongs to the `decode` method of the event. With this new implementation, this method does not need to catch any exception—the exceptions it was worrying about before are either handled by internal methods or deliberately left to be raised.

We should separate these fragments into different methods or functions. For connection management, a small function should be enough. This function will be in charge of trying to establish the connection, catching exceptions (should they occur), and logging them accordingly:

```
def connect_with_retry(connector, retry_n_times, retry_threshold=5):
    """Tries to establish the connection of <connector> retrying
    <retry_n_times>.

    If it can connect, returns the connection object.
    If it's not possible after the retries, raises ConnectionError

    :param connector: An object with a `.connect()` method.
    :param retry_n_times int: The number of times to try to call
        ``connector.connect()``.
    :param retry_threshold int: The time lapse between retry calls.

    """
    for _ in range(retry_n_times):
        try:
            return connector.connect()
        except ConnectionError as e:
            logger.info(
                "%s: attempting new connection in %is", e, retry_threshold
            )
```

```
        time.sleep(retry_threshold)
    exc = ConnectionError(f"Couldn't connect after {retry_n_times} times")
    logger.exception(exc)
    raise exc
```

Then, we will call this function in our method. As for the `ValueError` exception on the event, we could separate it with a new object and do composition, but for this limited case it would be overkill, so just moving the logic to a separate method would be enough. With these two considerations in place, the new version of the method looks much more compact and easier to read:

```
class DataTransport:
    """An example of an object that separates the exception handling by
    abstraction levels.
    """

    retry_threshold: int = 5
    retry_n_times: int = 3

    def __init__(self, connector):
        self._connector = connector
        self.connection = None

    def deliver_event(self, event):
        self.connection = connect_with_retry(
            self._connector, self.retry_n_times, self.retry_threshold
        )
        self.send(event)

    def send(self, event):
        try:
            return self.connection.send(event.decode())
        except ValueError as e:
            logger.error("%r contains incorrect data: %s", event, e)
            raise
```

Do not expose tracebacks

This is a security consideration. When dealing with exceptions, it might be acceptable to let them propagate if the error is too important, and maybe even let the program fail if this is the decision for that particular scenario and correctness was favored over robustness.

When there is an exception that denotes a problem, it's important to log in with as much detail as possible (including the traceback information, message, and all we can gather) so that the issue can be corrected efficiently. At the same time, we want to include as much detail as possible for ourselves—we definitely don't want any of this becoming visible to users.

In Python, tracebacks of exceptions contain very rich and useful debugging information. Unfortunately, this information is also very useful for attackers or malicious users who want to try and harm the application, not to mention that the leak would represent an important information disclosure, jeopardizing the intellectual property of your organization (parts of the code will be exposed).

If you choose to let exceptions propagate, make sure not to disclose any sensitive information. Also, if you have to notify users about a problem, choose generic messages (such as *Something went wrong*, or *Page not found*). This is a common technique used in web applications that display generic informative messages when an HTTP error occurs.

Avoid empty except blocks

This was even referred to as the most diabolical Python anti-pattern (REAL 01). While it is good to anticipate and defend our programs against some errors, being too defensive might lead to even worse problems. In particular, the only problem with being too defensive is that there is an empty `except` block that silently passes without doing anything.

Python is so flexible that it allows us to write code that can be faulty and yet, will not raise an error, like this:

```
try:
    process_data()
except:
    pass
```

The problem with this is that it will not fail, ever. Even when it should. It is also non-Pythonic if you remember from the zen of Python that errors should never pass silently.

If there is a true exception, this block of code will not fail, which might be what we wanted in the first place. But what if there is a defect? We need to know if there is an error in our logic to be able to correct it. Writing blocks such as this one will mask problems, making things harder to maintain.

There are two alternatives:

- Catch a more specific exception (not too broad, such as an `Exception`). In fact, some linting tools and IDEs will warn you in some cases when the code is handling too broad an exception.
- Do some actual error handling on the `except` block.

The best thing to do would be to apply both items simultaneously.

Handling a more specific exception (for example, `AttributeError` or `KeyError`) will make the program more maintainable because the reader will know what to expect, and can get an idea of the why of it. It will also leave other exceptions free to be raised, and if that happens, this probably means a bug, only this time it can be discovered.

Handling the exception itself can mean multiple things. In its simplest form, it could be just about logging the exception (make sure to use `logger.exception` or `logger.error` to provide the full context of what happened). Other alternatives could be to return a default value (substitution, only that in this case after detecting an error, not prior to causing it), or raising a different exception.



If you choose to raise a different exception, to include the original exception that caused the problem, which leads us to the next point.

Include the original exception

As part of our error handling logic, we might decide to raise a different one, and maybe even change its message. If that is the case, it is recommended to include the original exception that led to that.

In Python 3 (PEP-3134), we can now use the `raise <e> from <original_exception>` syntax. When using this construction, the original traceback will be embedded into the new exception, and the original exception will be set in the `__cause__` attribute of the resulting one.

For example, if we desire to wrap default exceptions with custom ones internally to our project, we could still do that while including information about the root exception:

```
class InternalDataError(Exception):
    """An exception with the data of our domain problem."""

def process(data_dictionary, record_id):
    try:
        return data_dictionary[record_id]
    except KeyError as e:
        raise InternalDataError("Record not present") from e
```



Always use the `raise <e> from <o>` syntax when changing the type of the exception.

Using assertions in Python

Assertions are to be used for situations that should never happen, so the expression on the `assert` statement has to mean an impossible condition. Should this condition happen, it means there is a defect in the software.

In contrast with the error handling approach, here there is (or should not be) a possibility of continuing the program. If such an error occurs, the program must stop. It makes sense to stop the program because, as commented before, we are in the presence of a defect, so there is no way to move forward by releasing a new version of the software that corrects this defect.

The idea of using assertions is to prevent the program from causing further damage if such an invalid scenario is presented. Sometimes, it is better to stop and let the program crash, rather than let it continue processing under the wrong assumptions.

For this reason, assertions should not be mixed with the business logic, or used as control flow mechanisms for the software. The following example is a bad idea:

```
try:
    assert condition.holds(), "Condition is not satisfied"
except AssertionError:
    alternative_procedure()
```



Do not catch the `AssertionError` exception.

Make sure that the program terminates when an assertion fails.

Include a descriptive error message in the assertion statement and log the errors to make sure that you can properly debug and correct the problem later on.

Another important reason why the previous code is a bad idea is that besides catching `AssertionError`, the statement in the assertion is a function call. Function calls can have side-effects, and they aren't always repeatable (we don't know if calling `condition.holds()` again will yield the same result). Moreover, if we stop the debugger at that line, we might not be able to conveniently see the result that causes the error, and, again, even if we call that function again, we don't know if that was the offending value.

A better alternative requires fewer lines of code and provides more useful information:

```
result = condition.holds()
assert result > 0, "Error with {0}".format(result)
```

Separation of concerns

This is a design principle that is applied at multiple levels. It is not just about the low-level design (code), but it is also relevant at a higher level of abstraction, so it will come up later when we talk about architecture.

Different responsibilities should go into different components, layers, or modules of the application. Each part of the program should only be responsible for a part of the functionality (what we call its concerns) and should know nothing about the rest.

The goal of separating concerns in software is to enhance maintainability by minimizing ripple effects. A **ripple** effect means the propagation of a change in the software from a starting point. This could be the case of an error or exception triggering a chain of other exceptions, causing failures that will result in a defect on a remote part of the application. It can also be that we have to change a lot of code scattered through multiple parts of the code base, as a result of a simple change in a function definition.

Clearly, we do not want these scenarios to happen. The software has to be easy to change. If we have to modify or refactor some part of the code that has to have a minimal impact on the rest of the application, the way to achieve this is through proper encapsulation.

In a similar way, we want any potential errors to be contained so that they don't cause major damage.

This concept is related to the DbC principle in the sense that each concern can be enforced by a contract. When a contract is violated, and an exception is raised as a result of such a violation, we know what part of the program has the failure, and what responsibilities failed to be met.

Despite this similarity, separation of concerns goes further. We normally think of contracts between functions, methods, or classes, and while this also applies to responsibilities that have to be separated, the idea of separation of concerns also applies to Python modules, packages, and basically any software component.

Cohesion and coupling

These are important concepts for good software design.

On the one hand, **cohesion** means that objects should have a small and well-defined purpose, and they should do as little as possible. It follows a similar philosophy as Unix commands that do only one thing and do it well. The more cohesive our objects are, the more useful and reusable they become, making our design better.

On the other hand, **coupling** refers to the idea of how two or more objects depend on each other. This dependency poses a limitation. If two parts of the code (objects or methods) are too dependent on each other, they bring with them some undesired consequences:

- **No code reuse:** If one function depends too much on a particular object, or takes too many parameters, it's coupled with this object, which means that it will be really difficult to use that function in a different context (in order to do so, we will have to find a suitable parameter that complies with a very restrictive interface)
- **Ripple effects:** Changes in one of the two parts will certainly impact the other, as they are too close
- **Low level of abstraction:** When two functions are so closely related, it is hard to see them as different concerns resolving problems at different levels of abstraction



Rule of thumb: Well-defined software will achieve high cohesion and low coupling.

Acronyms to live by

In this section, we will review some principles that yield some good design ideas. The point is to quickly relate to good software practices by acronyms that are easy to remember, working as a sort of mnemonic rule. If you keep these words in mind, you will be able to associate them with good practices more easily, and finding the right idea behind a particular line of code that you are looking at will be faster.

These are by no means formal or academic definitions, but more like empirical ideas that emerged from years of working in the software industry. Some of them do appear in books, as they were coined by important authors (see the references to investigate them in more detail), and others have their roots probably in blog posts, papers, or conference talks.

DRY/OA OO

The ideas of **Don't Repeat Yourself (DRY)** and **Once and Only Once (OA OO)** are closely related, so they were included together here. They are self-explanatory, you should avoid duplication at all costs.

Things in the code, knowledge, have to be defined only once and in a single place. When you have to make a change in the code, there should be only one rightful location to modify. Failure to do so is a sign of a poorly designed system.

Code duplication is a problem that directly impacts maintainability. It is very undesirable to have code duplication because of its many negative consequences:

- **It's error prone:** When some logic is repeated multiple times throughout the code, and this needs to change, it means we depend on efficiently correcting all the instances with this logic, without forgetting of any of them, because in that case there will be a bug.
- **It's expensive:** Linked to the previous point, making a change in multiple places takes much more time (development and testing effort) than if it was defined only once. This will slow the team down.
- **It's unreliable:** Also linked to the first point, when multiple places need to be changed for a single change in the context, you rely on the person who wrote the code to remember all the instances where the modification has to be made. There is no single source of truth.

Duplication is often caused by ignoring (or forgetting) that code represents knowledge. By giving meaning to certain parts of the code, we are identifying and labeling that knowledge.

Let's see what this means with an example. Imagine that, in a study center, students are ranked by the following criteria: 11 points per exam passed, minus five points per exam failed, and minus two per year in the institution. The following is not actual code, but just a representation of how this might be scattered in a real code base:

```
def process_students_list(students):
    # do some processing...

    students_ranking = sorted(
        students, key=lambda s: s.passed * 11 - s.failed * 5 - s.years * 2
    )
    # more processing
    for student in students_ranking:
        print(
            "Name: {0}, Score: {1}".format(
                student.name,
                (student.passed * 11 - student.failed * 5 - student.years *
2),
            )
        )
```

Notice how the lambda which is in the key of the sorted function represents some valid knowledge from the domain problem, yet it doesn't reflect it (it doesn't have a name, a proper and rightful location, there is no meaning assigned to that code, nothing). This lack of meaning in the code leads to the duplication we find when the score is printed out while listing the ranking.

We should reflect our knowledge of our domain problem in our code, and our code will then be less likely to suffer from duplication and will be easier to understand:

```
def score_for_student(student):
    return student.passed * 11 - student.failed * 5 - student.years * 2

def process_students_list(students):
    # do some processing...

    students_ranking = sorted(students, key=score_for_student)
    # more processing
    for student in students_ranking:
        print(
            "Name: {0}, Score: {1}".format(
                student.name, score_for_student(student)
            )
        )
```

A fair disclaimer: this is just an analysis of one of the traits of code duplication. In reality, there are more cases, types, and taxonomies of code duplication, entire chapters could be dedicated to this topic, but here we focus on one particular aspect to make the idea behind the acronym clear.

In this example, we have taken what is probably the simplest approach to eliminating duplication: creating a function. Depending on the case, the best solution would be different. In some cases, there might be an entirely new object that has to be created (maybe an entire abstraction was missing). In other cases, we can eliminate duplication with a context manager. Iterators or generators (described in [Chapter 7, Using Generators](#)) could also help to avoid repetition in the code, and decorators (explained in [Chapter 5, Using Decorators to Improve Our Code](#)), will also help.

Unfortunately, there is no general rule or pattern to tell you which of the features of Python are the most suitable to address code duplication, but hopefully, after seeing the examples in this book, and how the elements of Python are used, the reader will be able to develop his/her own intuition.

YAGNI

YAGNI (short for **You Ain't Gonna Need It**) is an idea you might want to keep in mind very often when writing a solution if you do not want to over-engineer it.

We want to be able to easily modify our programs, so we want to make them future-proof. In line with that, many developers think that they have to anticipate all future requirements and create solutions that are very complex, and so create abstractions that are hard to read, maintain, and understand. Sometime later, it turns out that those anticipated requirements do not show up, or they do but in a different way (surprise!), and the original code that was supposed to handle precisely that does not work. The problem is that now it is even harder to refactor and extend our programs. What happened was that the original solution did not handle the original requirements correctly, and neither do the current ones, simply because it is the wrong abstraction.

Having maintainable software is not about anticipating future requirements (do not do futurology!). It is about writing software that only addresses current requirements in such a way that it will be possible (and easy) to change later on. In other words, when designing, make sure that your decisions don't tie you down, and that you will be able to keep on building, but do not build more than what's necessary.

KIS

KIS (stands for **Keep It Simple**) relates very much to the previous point. When you are designing a software component, avoid over-engineering it; ask yourself if your solution is the minimal one that fits the problem.

Implement minimal functionality that correctly solves the problem and does not complicate your solution more than is necessary. Remember: the simpler the design, the more maintainable it will be.

This design principle is an idea we will want to keep in mind at all levels of abstraction, whether we are thinking of a high-level design, or addressing a particular line of code.

At a high-level, think on the components we are creating. Do we really need all of them? Does this module actually require being utterly extensible right now? Emphasize the last part—maybe we want to make that component extensible, but now is not the right time, or it is not appropriate to do so because we still do not have enough information to create the proper abstractions, and trying to come up with generic interfaces at this point will only lead to even worse problems.

In terms of code, keeping it simple usually means using the smallest data structure that fits the problem. You will most likely find it in the standard library.

Sometimes, we might over-complicate code, creating more functions or methods than what's necessary. The following class creates a namespace from a set of keyword arguments that have been provided, but it has a rather complicated code interface:

```
class ComplicatedNamespace:
    """An convoluted example of initializing an object with some
    properties."""

    ACCEPTED_VALUES = ("id_", "user", "location")

    @classmethod
    def init_with_data(cls, **data):
        instance = cls()
        for key, value in data.items():
            if key in cls.ACCEPTED_VALUES:
                setattr(instance, key, value)
        return instance
```

Having an extra class method for initializing the object doesn't seem really necessary. Then, the iteration, and the call to `setattr` inside it, make things even more strange, and the interface that is presented to the user is not very clear:

```
>>> cn = ComplicatedNamespace.init_with_data(
...     id_=42, user="root", location="127.0.0.1", extra="excluded"
... )
>>> cn.id_, cn.user, cn.location
(42, 'root', '127.0.0.1')

>>> hasattr(cn, "extra")
False
```

The user has to know of the existence of this other method, which is not convenient. It would be better to keep it simple, and just initialize the object as we initialize any other object in Python (after all, there is a method for that) with the `__init__` method:

```
class Namespace:
    """Create an object from keyword arguments."""

    ACCEPTED_VALUES = ("id_", "user", "location")

    def __init__(self, **data):
        accepted_data = {
            k: v for k, v in data.items() if k in self.ACCEPTED_VALUES
        }
        self.__dict__.update(accepted_data)
```

Remember the zen of Python: simple is better than complex.

EAFP/LBYL

EAFP (stands for **Easier to Ask Forgiveness than Permission**), while **LBYL** (stands for **Look Before You Leap**).

The idea of EAFP is that we write our code so that it performs an action directly, and then we take care of the consequences later in case it doesn't work. Typically, this means try running some code, expecting it to work, but catching an exception if it doesn't, and then handling the corrective code on the except block.

This is the opposite of **LBYL**. As its name says, in the look before you leap approach, we first check what we are about to use. For example, we might want to check if a file is available before trying to operate with it:

```
if os.path.exists(filename):
    with open(filename) as f:
        ...
```

This might be good for other programming languages, but it is not the Pythonic way of writing code. Python was built with ideas such as **EAFP**, and it encourages you to follow them (remember, explicit is better than implicit). This code would instead be rewritten like this:

```
try:
    with open(filename) as f:
        ...
except FileNotFoundError as e:
    logger.error(e)
```



Prefer EAFP over LBYL.

Composition and inheritance

In object-oriented software design, there are often discussions as to how to address some problems by using the main ideas of the paradigm (polymorphism, inheritance, and encapsulation).

Probably the most commonly used of these ideas is inheritance—developers often start by creating a class hierarchy with the classes they are going to need and decide the methods each one should implement.

While inheritance is a powerful concept, it does come with its perils. The main one is that every time we extend a base class, we are creating a new one that is tightly coupled with the parent. As we have already discussed, coupling is one of the things we want to reduce to a minimum when designing software.

One of the main uses developers relate inheritance with is code reuse. While we should always embrace code reuse, it is not a good idea to force our design to use inheritance to reuse code just because we get the methods from the parent class for free. The proper way to reuse code is to have highly cohesive objects that can be easily composed and that could work on multiple contexts.

When inheritance is a good decision

We have to be careful when creating a derived class, because this is a double-edged sword—on the one hand, it has the advantage that we get all the code of the methods from the parent class for free, but on the other hand, we are carrying all of them to a new class, meaning that we might be placing too much functionality in a new definition.

When creating a new subclass, we have to think if it is actually going to use all of the methods it has just inherited, as a heuristic to see if the class is correctly defined. If instead, we find out that we do not need most of the methods, and have to override or replace them, this is a design mistake that could be caused by several reasons:

- The superclass is vaguely defined and contains too much responsibility, instead of a well-defined interface
- The subclass is not a proper specialization of the superclass it is trying to extend

A good case for using inheritance is the type of situation when you have a class that defines certain components with its behavior that are defined by the interface of this class (its public methods and attributes), and then you need to specialize this class in order to create objects that do the same but with something else added, or with some particular parts of its behavior changed.

You can find examples of good uses of inheritance in the Python standard library itself. For example, in the `http.server` package (<https://docs.python.org/3/library/http.server.html#http.server.BaseHTTPRequestHandler>), we can find a base class such as `BaseHTTPRequestHandler`, and subclasses such as `SimpleHTTPRequestHandler` that extend this one by adding or changing part of its base interface.

Speaking of interface definition, this is another good use for inheritance. When we want to enforce the interface of some objects, we can create an abstract base class that does not implement the behavior itself, but instead just defines the interface—every class that extends this one will have to implement these to be a proper subtype.

Finally, another good case for inheritance is exceptions. We can see that the standard exception in Python derives from `Exception`. This is what allows you to have a generic clause such as `except Exception:`, which will catch every possible error. The important point is the conceptual one, they are classes derived from `Exception` because they are more specific exceptions. This also works in well-known libraries such as `requests`, for instance, in which an `HTTPError` is `RequestException`, which in turn is an `IOError`.

Anti-patterns for inheritance

If the previous section had to be summarized into a single word, it would be specialization. The correct use for inheritance is to specialize objects and create more detailed abstractions starting from base ones.

The parent (or base) class is part of the public definition of the new derived class. This is because the methods that are inherited will be part of the interface of this new class. For this reason, when we read the public methods of a class, they have to be consistent with what the parent class defines.

For example, if we see that a class derived from `BaseHTTPRequestHandler` implements a method named `handle()`, it would make sense because it is overriding one of the parents. If it had any other method whose name relates to an action that has to do with an HTTP request, then we could also think that is correctly placed (but we would not think that if we found something called `process_purchase()` on that class).

The previous illustration might seem obvious, but it is something that happens very often, especially when developers try to use inheritance with the sole goal of reusing code. In the next example, we will see a typical situation that represents a common anti-pattern in Python—there is a domain problem that has to be represented, and a suitable data structure is devised for that problem, but instead of creating an object that uses such a data structure, the object becomes the data structure itself.

Let's see these problems more concretely through an example. Imagine we have a system for managing insurance, with a module in charge of applying policies to different clients. We need to keep in memory a set of customers that are being processed at the time in order to apply those changes before further processing or persistence. The basic operations we need are to store a new customer with its records as satellite data, apply a change on a policy, or edit some of the data, just to name a few. We also need to support a batch operation, that is, when something on the policy itself changes (the one this module is currently processing), we have to apply these changes overall to customers on the current transaction.

Thinking in terms of the data structure we need, we realize that accessing the record for a particular customer in constant time is a nice trait. Therefore, something like `policy_transaction[customer_id]` looks like a nice interface. From this, we might think that a subscriptable object is a good idea, and further on, we might get carried away into thinking that the object we need is a dictionary:

```
class TransactionalPolicy(collections.UserDict):
    """Example of an incorrect use of inheritance."""

    def change_in_policy(self, customer_id, **new_policy_data):
        self[customer_id].update(**new_policy_data)
```

With this code, we can get information about a policy for a customer by its identifier:

```
>>> policy = TransactionalPolicy({
...     "client001": {
...         "fee": 1000.0,
...         "expiration_date": datetime(2020, 1, 3),
...     }
... })
>>> policy["client001"]
{'fee': 1000.0, 'expiration_date': datetime.datetime(2020, 1, 3, 0, 0)}
>>> policy.change_in_policy("client001", expiration_date=datetime(2020, 1,
4))
>>> policy["client001"]
{'fee': 1000.0, 'expiration_date': datetime.datetime(2020, 1, 4, 0, 0)}
```

Sure, we achieved the interface we wanted in the first place, but at what cost? Now, this class has a lot of extra behavior from carrying out methods that weren't necessary:

```
>>> dir(policy)
[ # all magic and special method have been omitted for brevity...
'change_in_policy', 'clear', 'copy', 'data', 'fromkeys', 'get', 'items',
'keys', 'pop', 'popitem', 'setdefault', 'update', 'values']
```

There are (at least) two major problems with this design. On the one hand, the hierarchy is wrong. Creating a new class from a base one conceptually means that it's a more specific version of the class it's extending (hence the name). How is it that a `TransactionalPolicy` is a dictionary? Does this make sense? Remember, this is part of the public interface of the object, so users will see this class, their hierarchy, and will notice such an odd specialization, as well as its public methods.

This leads us to the second problem—coupling. The interface of the transactional policy now includes all methods from a dictionary. Does a transactional policy really need methods such as `pop()` or `items()`? However, there they are. They are also public, so any user of this interface is entitled to call them, with whatever undesired side-effect they may carry. More on this point—we don't really gain much by extending a dictionary. The only method it actually needs to update for all customers affected by a change in the current policy (`change_in_policy()`) is not on the base class, so we will have to define it ourselves either way.

This is a problem of mixing implementation objects with domain objects. A dictionary is an implementation object, a data structure, suitable for certain kinds of operation, and with a trade-off like all data structures. A transactional policy should represent something in the domain problem, an entity that is part of the problem we are trying to solve.

Hierarchies like this one are incorrect, and just because we get a few magic methods from a base class (to make the object subscriptable by extending a dictionary) is not reason enough to create such an extension. Implementation classes should be extending solely when creating other, more specific, implementation classes. In other words, extend a dictionary if you want to create another (more specific, or slightly modified) dictionary. The same rule applies to classes of the domain problem.

The correct solution here is to use composition. `TransactionalPolicy` is not a dictionary—it uses a dictionary. It should store a dictionary in a private attribute, and implement `__getitem__()` by proxying from that dictionary and then only implementing the rest of the public method it requires:

```
class TransactionalPolicy:
    """Example refactored to use composition."""

    def __init__(self, policy_data, **extra_data):
        self._data = {**policy_data, **extra_data}

    def change_in_policy(self, customer_id, **new_policy_data):
        self._data[customer_id].update(**new_policy_data)

    def __getitem__(self, customer_id):
        return self._data[customer_id]

    def __len__(self):
        return len(self._data)
```

This way is not only conceptually correct, but also more extensible. If the underlying data structure (which, for now, is a dictionary) is changed in the future, callers of this object will not be affected, so long as the interface is maintained. This reduces coupling, minimizes ripple effects, allows for better refactoring (unit tests ought not to be changed), and makes the code more maintainable.

Multiple inheritance in Python

Python supports multiple inheritance. As inheritance, when improperly used, leads to design problems, you could also expect that multiple inheritance will also yield even bigger problems when it's not correctly implemented.

Multiple inheritance is, therefore, a double-edged sword. It can also be very beneficial in some cases. Just to be clear, there is nothing wrong with multiple inheritance—the only problem it has is that when it's not implemented correctly, it will multiply the problems.

Multiple inheritance is a perfectly valid solution when used correctly, and this opens up new patterns (such as the adapter pattern we discussed in *Chapter 9, Common Design Patterns*) and mixins.

One of the most powerful applications of multiple inheritance is perhaps that which enables the creation of mixins. Before exploring mixins, we need to understand how multiple inheritance works, and how methods are resolved in a complex hierarchy.

Method Resolution Order (MRO)

Some people don't like multiple inheritance because of the constraints it has in other programming languages, for instance, the so-called diamond problem. When a class extends from two or more, and all of those classes also extend from other base classes, the bottom ones will have multiple ways to resolve the methods coming from the top-level classes. The question is, which of these implementations is used?

Consider the following diagram, which has a structure with multiple inheritance. The top-level class has a class attribute and implements the `__str__` method. Think of any of the concrete classes, for example, `ConcreteModuleA12`—it extends from `BaseModule1` and `BaseModule2`, and each one of them will take the implementation of `__str__` from `BaseModule`. Which of these two methods is going to be the one for `ConcreteModuleA12`?

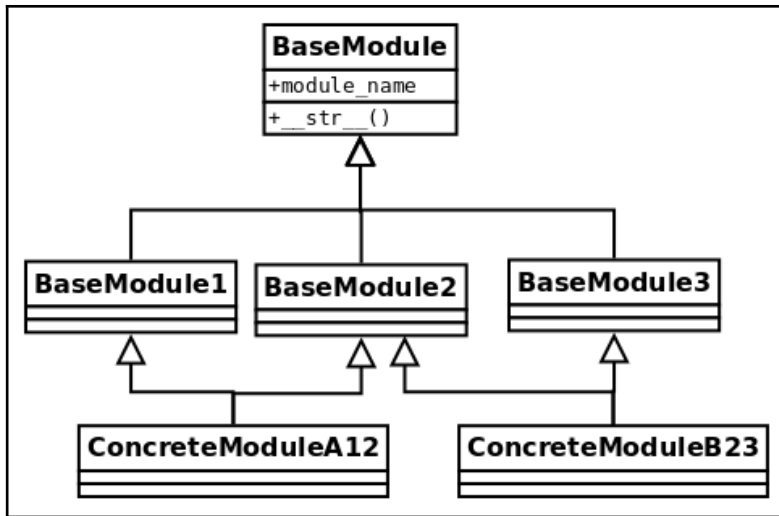

With the value of the class attribute, this will become evident:

```

class BaseModule:
    module_name = "top"

    def __init__(self, module_name):
        self.name = module_name

    def __str__(self):
        return f"{self.module_name}:{self.name}"

class BaseModule1(BaseModule):
    module_name = "module-1"

class BaseModule2(BaseModule):
    module_name = "module-2"

class BaseModule3(BaseModule):
    module_name = "module-3"

class ConcreteModuleA12(BaseModule1, BaseModule2):
    """Extend 1 & 2"""
  
```

```
class ConcreteModuleB23(BaseModule2, BaseModule3):
    """Extend 2 & 3"""
```

Now, let's test this to see what method is being called:

```
>>> str(ConcreteModuleA12("test"))
'module-1:test'
```

There is no collision. Python resolves this by using an algorithm called **C3 linearization** or MRO, which defines a deterministic way in which methods are going to be called.

In fact, we can specifically ask the class for its resolution order:

```
>>> [cls.__name__ for cls in ConcreteModuleA12.mro()]
['ConcreteModuleA12', 'BaseModule1', 'BaseModule2', 'BaseModule', 'object']
```

Knowing about how the method is going to be resolved in a hierarchy can be used to our advantage when designing classes because we can make use of mixins.

Mixins

A mixin is a base class that encapsulates some common behavior with the goal of reusing code. Typically, a mixin class is not useful on its own, and extending this class alone will certainly not work, because most of the time it depends on methods and properties that are defined in other classes. The idea is to use mixin classes along with other ones, through multiple inheritance, so that the methods or properties used on the mixin will be available.

Imagine we have a simple parser that takes a string and provides iteration over it by its values separated by hyphens (-):

```
class BaseTokenizer:

    def __init__(self, str_token):
        self.str_token = str_token

    def __iter__(self):
        yield from self.str_token.split("-")
```

This is quite straightforward:

```
>>> tk = BaseTokenizer("28a2320b-fd3f-4627-9792-a2b38e3c46b0")
>>> list(tk)
['28a2320b', 'fd3f', '4627', '9792', 'a2b38e3c46b0']
```

But now we want the values to be sent in upper-case, without altering the base class. For this simple example, we could just create a new class, but imagine that a lot of classes are already extending from `BaseTokenizer`, and we don't want to replace all of them. We can mix a new class into the hierarchy that handles this transformation:

```
class UpperIterableMixin:
    def __iter__(self):
        return map(str.upper, super().__iter__())

class Tokenizer(UpperIterableMixin, BaseTokenizer):
    pass
```

The new `Tokenizer` class is really simple. It doesn't need any code because it takes advantage of the mixin. This type of mixing acts as a sort of decorator. Based on what we just saw, `Tokenizer` will take `__iter__` from the mixin, and this one, in turn, delegates to the next class on the line (by calling `super()`), which is the `BaseTokenizer`, but it converts its values to uppercase, creating the desired effect.

Arguments in functions and methods

In Python, functions can be defined to receive arguments in several different ways, and these arguments can also be provided by callers in multiple ways.

There is also an industry-wide set of practices for defining interfaces in software engineering that closely relates to the definition of arguments in functions.

In this section, we will first explore the mechanics of arguments in Python functions and afterwards review the general principles of software engineering that relate to good practices on this subject to finally relate both concepts.

How function arguments work in Python

First, we will explore the particularities of how arguments are passed to functions in Python, and then we will review the general theory of good software engineering practices that relate to these concepts.

By first understanding the possibilities that Python offers for handling parameters, we will be able to assimilate general rules more easily, and the idea is that after having done so, we can easily draw conclusions on what good patterns or idioms are when handling arguments. Then, we can identify in which scenarios the Pythonic approach is the correct one, and in which cases we might be abusing the features of the language.

How arguments are copied to functions

The first rule in Python is that all arguments are passed by a value. Always. This means that when passing values to functions, they are assigned to the variables on the signature definition of the function to be later used on it. You will notice that a function changing arguments might depend on the type arguments—if we are passing `mutable` objects, and the body of the function modifies this, then, of course, we have side-effect that they will have been changed by the time the function returns.

In the following we can see the difference:

```
>>> def function(argument):
...     argument += " in function"
...     print(argument)
...
>>> immutable = "hello"
>>> function(immutable)
hello in function
>>> mutable = list("hello")
>>> immutable
'hello'
>>> function(mutable)
['h', 'e', 'l', 'l', 'o', ' ', 'i', 'n', ' ', 'f', 'u', 'n', 'c', 't', 'i',
'o', 'n']
>>> mutable
['h', 'e', 'l', 'l', 'o', ' ', 'i', 'n', ' ', 'f', 'u', 'n', 'c', 't', 'i',
'o', 'n']
>>>
```

This might look like an inconsistency, but it's not. When we pass the first argument, a string, this is assigned to the argument on the function. Since string objects are immutable, a statement like `argument += <expression>` will in fact create the new object, `argument + <expression>`, and assign that back to the argument. At that point, an argument is just a local variable inside the scope of the function and has nothing to do with the original one in the caller.

On the other hand, when we pass `list`, which is a mutable object, then that statement has a different meaning (it's actually equivalent to calling `.extend()` on that `list`). This operator acts by modifying the `list` in-place over a variable that holds a reference to the original `list` object, hence modifying it.

We have to be careful when dealing with these types of parameter because it can lead to unexpected side-effects. Unless you are absolutely sure that it is correct to manipulate mutable arguments in this way, we would recommend avoiding it and going for alternatives without these problems.



Don't mutate function arguments. In general, try to avoid side-effects in functions as much as possible.

Arguments in Python can be passed by position, as in many other programming languages, but also by keyword. This means that we can explicitly tell the function which values we want for which of its parameters. The only caveat is that after a parameter is passed by keyword, the rest that follow must also be passed this way, otherwise, `SyntaxError` will be raised.

Variable number of arguments

Python, as well as other languages, has built-in functions and constructions that can take a variable number of arguments. Consider for example string interpolation functions (whether it be by using the `%` operator or the `format` method for strings), which follow a similar structure to the `printf` function in C, a first positional parameter with the string format, followed by any number of arguments that will be placed on the markers of that formatting string.

Besides taking advantage of these functions that are available in Python, we can also create our own, which will work in a similar fashion. In this section, we will cover the basic principles of functions with a variable number of arguments, along with some recommendations, so that in the next section, we can explore how to use these features to our advantage when dealing with common problems, issues, and constraints that functions might have if they have too many arguments.

For a variable number of positional arguments, the star symbol (`*`) is used, preceding the name of the variable that is packing those arguments. This works through the packing mechanism of Python.

Let's say there is a function that takes three positional arguments. In one part of the code, we conveniently happen to have the arguments we want to pass to the function inside a list, in the same order as they are expected by the function. Instead of passing them one by one by the position (that is, `list[0]` to the first element, `list[1]` to the second, and so on), which would be really un-Pythonic, we can use the packing mechanism and pass them all together in a single instruction:

```
>>> def f(first, second, third):
...     print(first)
...     print(second)
...     print(third)
...
>>> l = [1, 2, 3]
>>> f(*l)
1
2
3
```

The nice thing about the packing mechanism is that it also works the other way around. If we want to extract the values of a list to variables, by their respective position, we can assign them like this:

```
>>> a, b, c = [1, 2, 3]
>>> a
1
>>> b
2
>>> c
3
```

Partial unpacking is also possible. Let's say we are just interested in the first values of a sequence (this can be a list, tuple, or something else), and after some point we just want the rest to be kept together. We can assign the variables we need and leave the rest under a packaged list. The order in which we unpack is not limited. If there is nothing to place in one of the unpacked subsections, the result will be an empty list. The reader is encouraged to try examples such as those presented in the following listing on a Python terminal, and also to explore that unpacking works with generators as well:

```
>>> def show(e, rest):
...     print("Element: {0} - Rest: {1}".format(e, rest))
...
>>> first, *rest = [1, 2, 3, 4, 5]
>>> show(first, rest)
Element: 1 - Rest: [2, 3, 4, 5]
>>> *rest, last = range(6)
>>> show(last, rest)
```

```
Element: 5 - Rest: [0, 1, 2, 3, 4]
>>> first, *middle, last = range(6)
>>> first
0
>>> middle
[1, 2, 3, 4]
>>> last
5
>>> first, last, *empty = (1, 2)
>>> first
1
>>> last
2
>>> empty
[]
```

One of the best uses for unpacking variables can be found in iteration. When we have to iterate over a sequence of elements, and each element is, in turn, a sequence, it is a good idea to unpack at the same time each element is being iterated over. To see an example of this in action, we are going to pretend that we have a function that receives a list of database rows, and that it is in charge of creating users out of that data. The first implementation takes the values to construct the user with from the position of each column in the row, which is not idiomatic at all. The second implementation uses unpacking while iterating:

```
USERS = [(i, f"first_name_{i}", "last_name_{i}") for i in range(1_000)]
```

```
class User:
    def __init__(self, user_id, first_name, last_name):
        self.user_id = user_id
        self.first_name = first_name
        self.last_name = last_name

def bad_users_from_rows(dbrows) -> list:
    """A bad case (non-pythonic) of creating ``User``s from DB rows."""
    return [User(row[0], row[1], row[2]) for row in dbrows]

def users_from_rows(dbrows) -> list:
    """Create ``User``s from DB rows."""
    return [
        User(user_id, first_name, last_name)
        for (user_id, first_name, last_name) in dbrows
    ]
```

Notice that the second version is much easier to read. In the first version of the function (`bad_users_from_rows`), we have data expressed in the form `row[0]`, `row[1]`, and `row[2]`, which doesn't tell us anything about what they are. On the other hand, variables such as `user_id`, `first_name`, and `last_name` speak for themselves.

We can leverage this kind of functionality to our advantage when designing our own functions.

An example of this that we can find in the standard library lies in the `max` function, which is defined as follows:

```
max(...)  
max(iterable, *[, default=obj, key=func]) -> value  
max(arg1, arg2, *args, *[, key=func]) -> value  
With a single iterable argument, return its biggest item. The  
default keyword-only argument specifies an object to return if  
the provided iterable is empty.  
With two or more arguments, return the largest argument.
```

There is a similar notation, with two stars (`**`) for keyword arguments. If we have a dictionary and we pass it with a double star to a function, what it will do is pick the keys as the name for the parameter, and pass the value for that key as the value for that parameter in that function.

For instance, check this out:

```
function(**{"key": "value"})
```

It is the same as the following:

```
function(key="value")
```

Conversely, if we define a function with a parameter starting with two-star symbols, the opposite will happen—keyword-provided parameters will be packed into a dictionary:

```
>>> def function(**kwargs):  
...     print(kwargs)  
...  
>>> function(key="value")  
{'key': 'value'}
```

The number of arguments in functions

In this section, we agree on the idea that having functions or methods that take too many arguments is a sign of bad design (a code smell). Then, we propose ways of dealing with this issue.

The first alternative is a more general principle of software design—**reification** (creating a new object for all of those arguments that we are passing, which is probably the abstraction we are missing). Compacting multiple arguments into a new object is not a solution specific to Python, but rather something that we can apply in any programming language.

Another option would be to use the Python-specific features we saw in the previous section, making use of variable positional and keyword arguments to create functions that have a dynamic signature. While this might be a Pythonic way of proceeding, we have to be careful not to abuse the feature, because we might be creating something that is so dynamic that it is hard to maintain. In this case, we should take a look at the body of the function. Regardless of the signature, and whether the parameters seem to be correct, if the function is doing too many different things responding to the values of the parameters, then it is a sign that it has to be broken down into multiple smaller functions (remember, functions should do one thing, and one thing only!).

Function arguments and coupling

The more arguments a function signature has, the more likely this one is going to be tightly coupled with the caller function.

Let's say we have two functions, f_1 , and f_2 , and the latter takes five parameters. The more parameters f_2 takes, the more difficult it would be for anyone trying to call that function to gather all that information and pass it along so that it can work properly.

Now, f_1 seems to have all of this information because it can call it correctly. From this, we can derive two conclusions: first, f_2 is probably a leaky abstraction, which means that since f_1 knows everything that f_2 requires, it can pretty much figure out what it is doing internally and will be able to do it by itself. So, all in all, f_2 is not abstracting that much. Second, it looks like f_2 is only useful to f_1 , and it is hard to imagine using this function in a different context, making it harder to reuse.

When functions have a more general interface and are able to work with higher-level abstractions, they become more reusable.

This applies to all sort of functions and object methods, including the `__init__` method for classes. The presence of a method like this could generally (but not always) mean that a new higher-level abstraction should be passed instead, or that there is a missing object.



If a function needs too many parameters to work properly, consider it a code smell.

In fact, this is such a design problem that static analysis tools such as `pylint` (discussed in Chapter 1, *Introduction, Code Formatting, and Tools*) will, by default, raise a warning about when they encounter such a case. When this happens, don't suppress the warning—refactor it instead.

Compact function signatures that take too many arguments

Suppose we find a function that requires too many parameters. We know that we cannot leave the code base like that, and a refactor is imperative. But, what are the options?

Depending on the case, some of the following rules might apply. This is by no means extensive, but it does provide an idea of how to solve some scenarios that occur quite often.

Sometimes, there is an easy way to change parameters if we can see that most of them belong to a common object. For example, consider a function call like this one:

```
track_request(request.headers, request.ip_addr, request.request_id)
```

Now, the function might or might not take additional arguments, but something is really obvious here: all of the parameters depend upon `request`, so why not pass the `request` object instead? This is a simple change, but it significantly improves the code. The correct function call should be `track_request(request)`—not to mention that, semantically, it also makes much more sense.

While passing around parameters like this is encouraged, in all cases where we pass mutable objects to functions, we must be really careful about side-effects. The function we are calling should not make any modifications to the object we are passing because that will mutate the object, creating an undesired side-effect. Unless this is actually the desired effect (in which case, it must be made explicit), this kind of behavior is discouraged. Even when we actually want to change something on the object we are dealing with, a better alternative would be to copy it and return a (new) modified version of it.



Work with immutable objects, and avoid side-effects as much as possible.

This brings us to a similar topic: grouping parameters. In the previous example, the parameters were already grouped, but the group (in this case, the request object) was not being used. But other cases are not as obvious as that one, and we might want to group all the data in the parameters in a single object that acts as a container. Needless to say, this grouping has to make sense. The idea here is to *reify*: create the abstraction that was missing from our design.

If the previous strategies don't work, as a last resort we can change the signature of the function to accept a variable number of arguments. If the number of arguments is too big, using `*args` or `**kwargs` will make things harder to follow, so we have to make sure that the interface is properly documented and correctly used, but in some cases this is worth doing.

It's true that a function defined with `*args` and `**kwargs` is really flexible and adaptable, but the disadvantage is that it loses its signature, and with that, part of its meaning, and almost all of its legibility. We have seen examples of how names for variables (including function arguments) make the code much easier to read. If a function will take any number of arguments (positional or keyword), we might find out that when we want to take a look at that function in the future, we probably won't know exactly what it was supposed to do with its parameters, unless it has a very good docstring.

Final remarks on good practices for software design

A good software design involves a combination of following good practices of software engineering and taking advantage of most of the features of the language. There is a great value in using everything that Python has to offer, but there is also a great risk of abusing this and trying to fit complex features into simple designs.

In addition to this general principle, it would be good to add some final recommendations.

Orthogonality in software

This word is very general and can have multiple meanings or interpretations. In math, orthogonal means that two elements are independent. If two vectors are orthogonal, their scalar product is zero. It also means they are not related at all: a change in one of them doesn't affect the other one at all. That's the way we should think about our software.

Changing a module, class, or function should have no impact on the outside world to that component that is being modified. This is of course highly desirable, but not always possible. But even for cases where it's not possible, a good design will try to minimize the impact as much as possible. We have seen ideas such as separation of concerns, cohesion, and isolation of components.

In terms of the runtime structure of software, orthogonality can be interpreted as the fact that makes changes (or side-effects) local. This means, for instance, that calling a method on an object should not alter the internal state of other (unrelated) objects. We have already (and will continue to do so) emphasized in this book the importance of minimizing side-effects in our code.

In the example with the mixin class, we created a `tokenizer` object that returned an iterable. The fact that the `__iter__` method returned a new generator increases the chances that all three classes (the base, the mixing, and the concrete class) are orthogonal. If this had returned something in concrete (a list, let's say), this would have created a dependency on the rest of the classes, because when we changed the list to something else, we might have needed to update other parts of the code, revealing that the classes were not as independent as they should be.

Let's show you a quick example. Python allows passing functions by parameter because they are just regular objects. We can use this feature to achieve some orthogonality. We have a function that calculates a price, including taxes and discounts, but afterward we want to format the final price that's obtained:

```
def calculate_price(base_price: float, tax: float, discount: float) ->
    return (base_price * (1 + tax)) * (1 - discount)

def show_price(price: float) -> str:
    return "$ {0:,.2f}".format(price)

def str_final_price(
    base_price: float, tax: float, discount: float, fmt_function=str
) -> str:
    return fmt_function(calculate_price(base_price, tax, discount))
```

Notice that the top-level function is composing two orthogonal functions. One thing to notice is how we calculate the price, which is how the other one is going to be represented. Changing one does not change the other. If we don't pass anything in particular, it will use string conversion as the default representation function, and if we choose to pass a custom function, the resulting string will change. However, changes in `show_price` do not affect `calculate_price`. We can make changes to either function, knowing that the other one will remain as it was:

```
>>> str_final_price(10, 0.2, 0.5)
'6.0'

>>> str_final_price(1000, 0.2, 0)
'1200.0'

>>> str_final_price(1000, 0.2, 0.1, fmt_function=show_price)
'$ 1,080.00'
```

There is an interesting quality aspect that relates to orthogonality. If two parts of the code are orthogonal, it means one can change without affecting the other. This implies that the part that changed has unit tests that are also orthogonal to the unit tests of the rest of the application. Under this assumption, if those tests pass, we can assume (up to a certain degree) that the application is correct without needing full regression testing.

More broadly, orthogonality can be thought of in terms of features. Two functionalities of the application can be totally independent so that they can be tested and released without having to worry that one might break the other (or the rest of the code, for that matter). Imagine that the project requires a new authentication mechanism (`oauth2`, let's say, but just for the sake of the example), and at the same time another team is also working on a new report. Unless there is something fundamentally wrong in that system, neither of those features should impact the other. Regardless of which one of those gets merged first, the other one should not be affected at all.

Structuring the code

The way code is organized also impacts the performance of the team and its maintainability.

In particular, having large files with lots of definitions (classes, functions, constants, and so on) is a bad practice and should be discouraged. This doesn't mean going to the extreme of placing one definition per file, but a good code base will structure and arrange components by similarity.

Luckily, most of the time, changing a large file into smaller ones is not a hard task in Python. Even if multiple other parts of the code depend on definitions made on that file, this can be broken down into a package, and will maintain total compatibility. The idea would be to create a new directory with a `__init__.py` file on it (this will make it a Python package). Alongside this file, we will have multiple files with all the particular definitions each one requires (fewer functions and classes grouped by a certain criterion). Then, the `__init__.py` file will import from all the other files the definitions it previously had (which is what guarantees its compatibility). Additionally, these definitions can be mentioned in the `__all__` variable of the module to make them exportable.

There are many advantages of this. Other than the fact that each file will be easier to navigate, and things will be easier to find, we could argue that it will be more efficient because of the following reasons:

- It contains fewer objects to parse and load into memory when the module is imported
- The module itself will probably be importing fewer modules because it needs fewer dependencies, like before

It also helps to have a convention for the project. For example, instead of placing constants in all of the files, we can create a file specific to the constant values to be used in the project, and import it from there:

```
from myproject.constants import CONNECTION_TIMEOUT
```

Centralizing information like this makes it easier to reuse code and helps to avoid inadvertent duplication.

More details about separating modules and creating Python packages will be discussed in Chapter 10, *Clean Architecture*, when we explore this in the context of software architecture.

Summary

In this chapter, we have explored several principles to achieve a clean design. Understanding that the code is part of the design is key to achieving high-quality software. This and the following chapter are focused precisely on that.

With these ideas, we can now construct more robust code. For example, by applying DbC, we can create components that are guaranteed to work under their constraints. More importantly, if errors occur, this will not happen out of the blue, but instead, we will have a clear idea of who the offender is and which part of the code broke the contract. This compartmentalization is clear to effective debugging.

Along similar lines, each component can be made more robust if it defends itself from malicious intent or incorrect input. Although this idea goes in a different direction from design by contract, it might complement it very well. Defensive programming is a good idea, especially for critical parts of the application.

For both approaches (design by contract and defensive programming), it's important to correctly handle assertions. Keep in mind how they should be used in Python, and don't use assertions as part of the control flow logic of the program. Don't catch this exception, either.

Speaking of exceptions, it's important to know how and when to use them, and the most important concept here is to avoid using exception as a control flow (go-to) kind of construction.

We have explored a recurrent topic in object-oriented design: deciding between using inheritance or composition. The main lesson here is not to use one over the other, but to use whichever option is better; we should also avoid some common anti-patterns, which we might often see in Python (especially given its highly dynamic nature).

Finally, we discussed the number of arguments in functions, along with heuristics for a clean design, always with the particularities of Python in mind.

These concepts are fundamental design ideas that lay the foundations for what's coming in the next chapter. We need to first understand these ideas so that we can move on to more advanced topics, such as SOLID principles.

References

Here is a list of information you can refer to:

- *Object-Oriented Software Construction, Second Edition*, written by Bertrand Meyer
- *The Pragmatic Programmer: From Journeyman to Master*, by Andrew Hunt and David Thomas published by Addison-Wesley, 2000.
- *PEP-316: Programming by Contract for Python* (<https://www.python.org/dev/peps/pep-0316/>)
- *REAL 01: The Most Diabolical Python Antipattern*: <https://realpython.com/blog/python/the-most-diabolical-python-antipattern/>
- *PEP-3134: Exception Chaining and Embedded Tracebacks* (<https://www.python.org/dev/peps/pep-3134/>)

-
- *Idiomatic Python: EAFP versus LBYL* (<https://blogs.msdn.microsoft.com/pythonengineering/2016/06/29/idiomatic-python-eafp-versus-lbyl/>)
 - *Composition vs. Inheritance: How to Choose?* (<https://www.thoughtworks.com/insights/blog/composition-vs-inheritance-how-choose>)
 - *Python HTTP* (<https://docs.python.org/3/library/http.server.html#http.server.BaseHTTPRequestHandler>)
 - *Source reference for exceptions in the requests library* (http://docs.python-requests.org/en/master/_modules/requests/exceptions/)
 - *Code Complete: A Practical Handbook of Software Construction, Second Edition*, written by Steve McConnell

4

The SOLID Principles

In this chapter, we will continue to explore concepts of clean design applied to Python. In particular, we will review the so-called **SOLID** principles, and how to implement them in a Pythonic way. These principles entail a series of good practices to achieve better-quality software. In case some of us aren't aware of what SOLID stands for, here it is:

- **S**: Single responsibility principle
- **O**: Open/closed principle
- **L**: Liskov's substitution principle
- **I**: Interface segregation principle
- **D**: Dependency inversion principle

The goals of this chapter are as follows:

- To become acquainted with SOLID principles for software design
- To design software components that follow the single responsibility principle
- To achieve more maintainable code through the open/closed principle
- To implement proper class hierarchies in object-oriented design, by complying with Liskov's substitution principle
- To design with interface segregation and dependency inversion

Single responsibility principle

The **single responsibility principle** (SRP) states that a software component (in general, a class) must have only one responsibility. The fact that the class has a sole responsibility means that it is in charge of doing just one concrete thing, and as a consequence of that, we can conclude that it must have only one reason to change.

Only if one thing on the domain problem changes will the class have to be updated. If we have to make modifications to a class, for different reasons, it means the abstraction is incorrect, and that the class has too many responsibilities.

As introduced in [Chapter 2, Pythonic Code](#), this design principle helps us build more cohesive abstractions; objects that do one thing, and just one thing, well, following the Unix philosophy. What we want to avoid in all cases is having objects with multiple responsibilities (often called **god-objects**, because they know too much, or more than they should). These objects group different (mostly unrelated) behaviors, thus making them harder to maintain.

Again, the smaller the class, the better.

The SRP is closely related to the idea of cohesion in software design, which we already explored in [Chapter 3, General Traits of Good Code](#), when we discussed separation of concerns in software. What we strive to achieve here is that classes are designed in such a way that most of their properties and their attributes are used by its methods, most of the time. When this happens, we know they are related concepts, and therefore it makes sense to group them under the same abstraction.

In a way, this idea is somehow similar to the concept of normalization on relational database design. When we detect that there are partitions on the attributes or methods of the interface of an object, they might as well be moved somewhere else—it is a sign that they are two or more different abstractions mixed into one.

There is another way of looking at this principle. If, when looking at a class, we find methods that are mutually exclusive and do not relate to each other, they are the different responsibilities that have to be broken down into smaller classes.

A class with too many responsibilities

In this example, we are going to create the case for an application that is in charge of reading information about events from a source (this could be log files, a database, or many more sources), and identifying the actions corresponding to each particular log.

A design that fails to conform to the SRP would look like this:

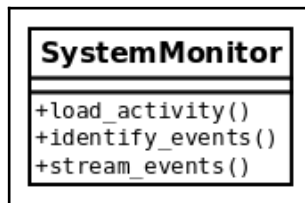

Without considering the implementation, the code for the class might look in the following listing:

```
# srp_1.py
class SystemMonitor:
    def load_activity(self):
        """Get the events from a source, to be processed."""

    def identify_events(self):
        """Parse the source raw data into events (domain objects)."""

    def stream_events(self):
        """Send the parsed events to an external agent."""
```

The problem with this class is that it defines an interface with a set of methods that correspond to actions that are orthogonal: each one can be done independently of the rest.

This design flaw makes the class rigid, inflexible, and error-prone because it is hard to maintain. In this example, each method represents a responsibility of the class. Each responsibility entails a reason why the class might need to be modified. In this case, each method represents one of the various reasons why the class will have to be modified.

Consider the loader method, which retrieves the information from a particular source. Regardless of how this is done (we can abstract the implementation details here), it is clear that it will have its own sequence of steps, for instance connecting to the data source, loading the data, parsing it into the expected format, and so on. If any of this changes (for example, we want to change the data structure used for holding the data), the `SystemMonitor` class will need to change. Ask yourself whether this makes sense. Does a system monitor object have to change because we changed the representation of the data? No.

The same reasoning applies to the other two methods. If we change how we fingerprint events, or how we deliver them to another data source, we will end up making changes to the same class.

It should be clear by now that this class is rather fragile, and not very maintainable. There are lots of different reasons that will impact on changes in this class. Instead, we want external factors to impact our code as little as possible. The solution, again, is to create smaller and more cohesive abstractions.

Distributing responsibilities

To make the solution more maintainable, we separate every method into a different class. This way, each class will have a single responsibility:

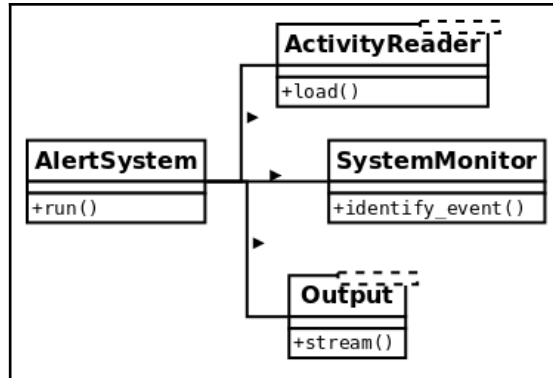

The same behavior is achieved by using an object that will interact with instances of these new classes, using those objects as collaborators, but the idea remains that each class encapsulates a specific set of methods that are independent of the rest. The idea now is that changes on any of these classes do not impact the rest, and all of them have a clear and specific meaning. If we need to change something on how we load events from the data sources, the alert system is not even aware of these changes, so we do not have to modify anything on the system monitor (as long as the contract is still preserved), and the data target is also unmodified.

Changes are now local, the impact is minimal, and each class is easier to maintain.

The new classes define interfaces that are not only more maintainable but also reusable. Imagine that now, in another part of the application, we also need to read the activity from the logs, but for different purposes. With this design, we can simply use objects of type `ActivityReader` (which would actually be an interface, but for the purposes of this section, that detail is not relevant and will be explained later for the next principles). This would make sense, whereas it would not have made sense in the previous design, because attempts to reuse the only class we had defined would have also carried extra methods (such as `identify_events()`, or `stream_events()`) that were not needed at all.

One important clarification is that the principle does not mean at all that each class must have a single method. Any of the new classes might have extra methods, as long as they correspond to the same logic that that class is in charge of handling.

The open/closed principle

The **open/closed principle** (OCP) states that a module should be both open and closed (but with respect to different aspects).

When designing a class, for instance, we should carefully encapsulate the logic so that it has good maintenance, meaning that we will want it to be **open to extension but closed for modification**.

What this means in simple terms is that, of course, we want our code to be extensible, to adapt to new requirements, or changes in the domain problem. This means that, when something new appears on the domain problem, we only want to add new things to our model, not change anything existing that is closed to modification.

If, for some reason, when something new has to be added, we found ourselves modifying the code, then that logic is probably poorly designed. Ideally, when requirements change, we want to just have to extend the module with the new required behavior in order to comply with the new requirements, but without having to modify the code.

This principle applies to several software abstractions. It could be a class or even a module. In the following two subsections, we will see examples of each one, respectively.

Example of maintainability perils for not following the open/closed principle

Let's begin with an example of a system that is designed in such a way that does not follow the open/closed principle, in order to see the maintainability problems this carries, and the inflexibility of such a design.

The idea is that we have a part of the system that is in charge of identifying events as they occur in another system, which is being monitored. At each point, we want this component to identify the type of event, correctly, according to the values of the data that was previously gathered (for simplicity, we will assume it is packaged into a dictionary, and was previously retrieved through another means such as logs, queries, and many more). We have a class that, based on this data, will retrieve the event, which is another type with its own hierarchy.

A first attempt to solve this problem might look like this:

```
# openclosed_1.py
class Event:
    def __init__(self, raw_data):
```

```
        self.raw_data = raw_data

class UnknownEvent(Event):
    """A type of event that cannot be identified from its data."""

class LoginEvent(Event):
    """A event representing a user that has just entered the system."""

class LogoutEvent(Event):
    """An event representing a user that has just left the system."""

class SystemMonitor:
    """Identify events that occurred in the system."""

    def __init__(self, event_data):
        self.event_data = event_data

    def identify_event(self):
        if (
            self.event_data["before"]["session"] == 0
            and self.event_data["after"]["session"] == 1
        ):
            return LoginEvent(self.event_data)
        elif (
            self.event_data["before"]["session"] == 1
            and self.event_data["after"]["session"] == 0
        ):
            return LogoutEvent(self.event_data)

        return UnknownEvent(self.event_data)
```

The following is the expected behavior of the preceding code:

```
>>> l1 = SystemMonitor({"before": {"session": 0}, "after": {"session": 1}})
>>> l1.identify_event().__class__.__name__
'LoginEvent'

>>> l2 = SystemMonitor({"before": {"session": 1}, "after": {"session": 0}})
>>> l2.identify_event().__class__.__name__
'LogoutEvent'

>>> l3 = SystemMonitor({"before": {"session": 1}, "after": {"session": 1}})
>>> l3.identify_event().__class__.__name__
'UnknownEvent'
```

We can clearly notice the hierarchy of event types, and some business logic to construct them. For instance, when there was no previous flag for a session, but there is now, we identify that record as a login event. Conversely, when the opposite happens, it means that it was a logout event. If it was not possible to identify an event, an event of type unknown is returned. This is to preserve polymorphism by following the null object pattern (instead of returning `None`, it retrieves an object of the corresponding type with some default logic). The null object pattern is described in [Chapter 9, Common Design Patterns](#).

This design has some problems. The first issue is that the logic for determining the types of events is centralized inside a monolithic method. As the number of events we want to support grows, this method will as well, and it could end up being a very long method, which is bad because, as we have already discussed, it will not be doing just one thing and one thing well.

On the same line, we can see that this method is not closed for modification. Every time we want to add a new type of event to the system, we will have to change something in this method (not to mention, that the chain of `elif` statements will be a nightmare to read!).

We want to be able to add new types of event without having to change this method (closed for modification). We also want to be able to support new types of event (open for extension) so that when a new event is added, we only have to add code, not change the code that already exists.

Refactoring the events system for extensibility

The problem with the previous example was that the `SystemMonitor` class was interacting directly with the concrete classes it was going to retrieve.

In order to achieve a design that honors the open/closed principle, we have to design toward abstractions.

A possible alternative would be to think of this class as it collaborates with the events, and then we delegate the logic for each particular type of event to its corresponding class:

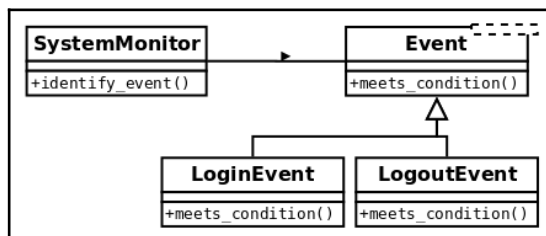

Then we have to add a new (polymorphic) method to each type of event with the single responsibility of determining if it corresponds to the data being passed or not, and we also have to change the logic to go through all events, finding the right one.

The new code should look like this:

```
# openclosed_2.py
class Event:
    def __init__(self, raw_data):
        self.raw_data = raw_data

    @staticmethod
    def meets_condition(event_data: dict):
        return False

class UnknownEvent(Event):
    """A type of event that cannot be identified from its data"""

class LoginEvent(Event):
    @staticmethod
    def meets_condition(event_data: dict):
        return (
            event_data["before"]["session"] == 0
            and event_data["after"]["session"] == 1
        )

class LogoutEvent(Event):
    @staticmethod
    def meets_condition(event_data: dict):
        return (
            event_data["before"]["session"] == 1
            and event_data["after"]["session"] == 0
        )

class SystemMonitor:
    """Identify events that occurred in the system."""

    def __init__(self, event_data):
        self.event_data = event_data

    def identify_event(self):
        for event_cls in Event.__subclasses__():
            try:
                if event_cls.meets_condition(self.event_data):
```



```

        return event_cls(self.event_data)
    except KeyError:
        continue
    return UnknownEvent(self.event_data)

```

Notice how the interaction is now oriented toward an abstraction (in this case, it would be the generic base class `Event`, which might even be an abstract base class or an interface, but for the purposes of this example it is enough to have a concrete base class). The method no longer works with specific types of event, but just with generic events that follow a common interface—they are all polymorphic with respect to the `meets_condition` method.

Notice how events are discovered through the `__subclasses__()` method. Supporting new types of event is now just about creating a new class for that event that has to inherit from `Event` and implement its own `meets_condition()` method, according to its specific business logic.

Extending the events system

Now, let's prove that this design is actually as extensible as we wanted it to be. Imagine that a new requirement arises, and we have to also support events that correspond to transactions that the user executed on the monitored system.

The class diagram for the design has to include such a new event type, as in the following:

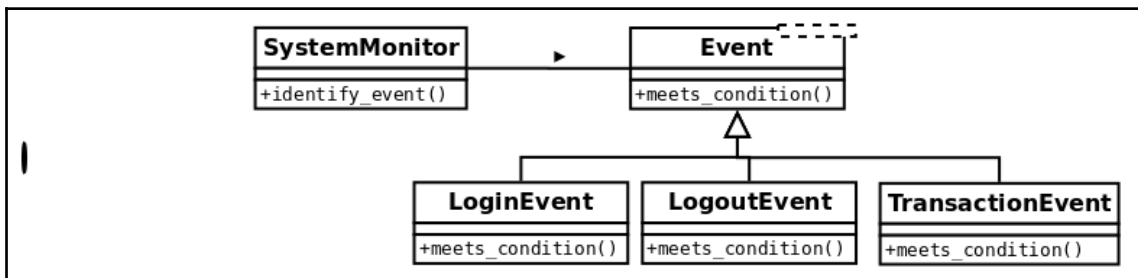

Only by adding the code to this new class does the logic keep working as expected:

```

# openclosed_3.py
class Event:
    def __init__(self, raw_data):
        self.raw_data = raw_data

    @staticmethod

```

```
def meets_condition(event_data: dict):
    return False

class UnknownEvent(Event):
    """A type of event that cannot be identified from its data"""

class LoginEvent(Event):
    @staticmethod
    def meets_condition(event_data: dict):
        return (
            event_data["before"]["session"] == 0
            and event_data["after"]["session"] == 1
        )

class LogoutEvent(Event):
    @staticmethod
    def meets_condition(event_data: dict):
        return (
            event_data["before"]["session"] == 1
            and event_data["after"]["session"] == 0
        )

class TransactionEvent(Event):
    """Represents a transaction that has just occurred on the system."""

    @staticmethod
    def meets_condition(event_data: dict):
        return event_data["after"].get("transaction") is not None

class SystemMonitor:
    """Identify events that occurred in the system."""

    def __init__(self, event_data):
        self.event_data = event_data

    def identify_event(self):
        for event_cls in Event.__subclasses__():
            try:
                if event_cls.meets_condition(self.event_data):
                    return event_cls(self.event_data)
            except KeyError:
                continue
        return UnknownEvent(self.event_data)
```

We can verify that the previous cases work as before and that the new event is also correctly identified:

```
>>> l1 = SystemMonitor({"before": {"session": 0}, "after": {"session": 1}})
>>> l1.identify_event().__class__.__name__
'LoginEvent'

>>> l2 = SystemMonitor({"before": {"session": 1}, "after": {"session": 0}})
>>> l2.identify_event().__class__.__name__
'LogoutEvent'

>>> l3 = SystemMonitor({"before": {"session": 1}, "after": {"session": 1}})
>>> l3.identify_event().__class__.__name__
'UnknownEvent'

>>> l4 = SystemMonitor({"after": {"transaction": "Tx001"}})
>>> l4.identify_event().__class__.__name__
'TransactionEvent'
```

Notice that the `SystemMonitor.identify_event()` method did not change at all when we added the new event type. We, therefore, say that this method is closed with respect to new types of event.

Conversely, the `Event` class allowed us to add a new type of event when we were required to do so. We then say that events are open for an extension with respect to new types.

This is the true essence of this principle—when something new appears on the domain problem, we only want to add new code, not modify existing code.

Final thoughts about the OCP

As you might have noticed, this principle is closely related to effective use of polymorphism. We want to design toward abstractions that respect a polymorphic contract that the client can use, to a structure that is generic enough that extending the model is possible, as long as the polymorphic relationship is preserved.

This principle tackles an important problem in software engineering: maintainability. The perils of not following the OCP are ripple effects and problems in the software where a single change triggers changes all over the code base, or risks breaking other parts of the code.

One important final note is that, in order to achieve this design in which we do not change the code to extend behavior, we need to be able to create proper closure against the abstractions we want to protect (in this example, new types of event). This is not always possible in all programs, as some abstractions might collide (for example, we might have a proper abstraction that provides closure against a requirement, but does not work for other types of requirements). In these cases, we need to be selective and apply a strategy that provides the best closure for the types of requirement that require to be the most extensible.

Liskov's substitution principle

Liskov's substitution principle (LSP) states that there is a series of properties that an object type must hold to preserve reliability on its design.

The main idea behind LSP is that, for any class, a client should be able to use any of its subtypes indistinguishably, without even noticing, and therefore without compromising the expected behavior at runtime. This means that clients are completely isolated and unaware of changes in the class hierarchy.

More formally, this is the original definition (LISKOV 01) of Liskov's substitution principle: if S is a subtype of T , then objects of type T may be replaced by objects of type S , without breaking the program.

This can be understood with the help of a generic diagram such as the following one. Imagine that there is some client class that requires (includes) objects of another type. Generally speaking, we will want this client to interact with objects of some type, namely, it will work through an interface.

Now, this type might as well be just a generic interface definition, an abstract class or an interface, not a class with the behavior itself. There may be several subclasses extending this type (described in the diagram with the name **Subtype**, up to **N**). The idea behind this principle is that, if the hierarchy is correctly implemented, the client class has to be able to work with instances of any of the subclasses without even noticing. These objects should be interchangeable, as shown here:

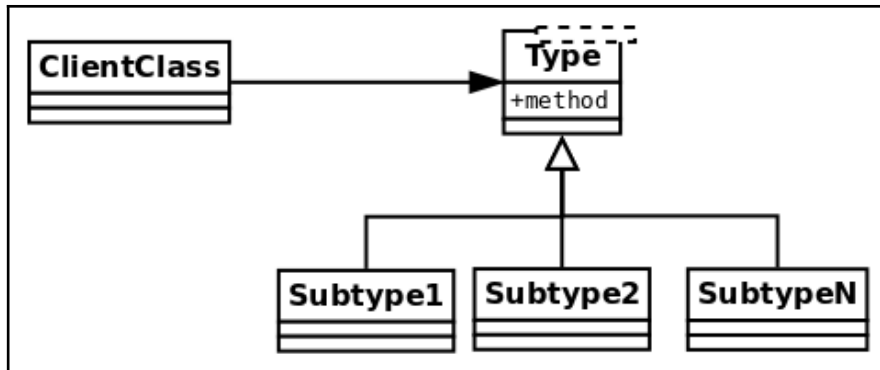

This is related to other design principles we have already visited, like designing to interfaces. A good class must define a clear and concise interface, and as long as subclasses honor that interface, the program will remain correct.

As a consequence of this, the principle also relates to the ideas behind designing by contract. There is a contract between a given type and a client. By following the rules of LSP, the design will make sure that subclasses respect the contracts as they are defined by parent classes.

Detecting LSP issues with tools

There are some scenarios so notoriously wrong with respect to the LSP that they can be easily identified by the tools we have learned to configure in [Chapter 1, Introduction, Code Formatting, and Tools](#) (mainly Mypy and Pylint).

Detecting incorrect datatypes in method signatures with Mypy

By using type annotations (as recommended previously in [Chapter 1, Introduction, Code Formatting, and Tools](#)), throughout our code, and configuring Mypy, we can quickly detect some basic errors early, and check basic compliance with LSP for free.

If one of the subclasses of the `Event` class were to override a method in an incompatible fashion, Mypy would notice this by inspecting the annotations:

```
class Event:
    ...
    def meets_condition(self, event_data: dict) -> bool:
        return False

class LoginEvent(Event):
    def meets_condition(self, event_data: list) -> bool:
        return bool(event_data)
```

When we run Mypy on this file, we will get an error message saying the following:

```
error: Argument 1 of "meets_condition" incompatible with supertype "Event"
```

The violation to LSP is clear—since the derived class is using a type for the `event_data` parameter which is different from the one defined on the base class, we cannot expect them to work equally. Remember that, according to this principle, any caller of this hierarchy has to be able to work with `Event` or `LoginEvent` transparently, without noticing any difference. Interchanging objects of these two types should not make the application fail. Failure to do so would break the polymorphism on the hierarchy.

The same error would have occurred if the return type was changed for something other than a Boolean value. The rationale is that clients of this code are expecting a Boolean value to work with. If one of the derived classes changes this return type, it would be breaking the contract, and again, we cannot expect the program to continue working normally.

A quick note about types that are not the same but share a common interface: even though this is just a simple example to demonstrate the error, it is still true that both dictionaries and lists have something in common; they are both iterables. This means that in some cases, it might be valid to have a method that expects a dictionary and another one expecting to receive a list, as long as both treat the parameters through the iterable interface. In this case, the problem would not lie in the logic itself (LSP might still apply), but in the definition of the types of the signature, which should read neither `list` nor `dict`, but a union of both. Regardless of the case, something has to be modified, whether it is the code of the method, the entire design, or just the type annotations, but in no case should we silence the warning and ignore the error given by Mypy.



Do not ignore errors such as this by using `# type: ignore` or something similar. Refactor or change the code to solve the real problem. The tools are reporting an actual design flaw for a valid reason.

Detecting incompatible signatures with Pylint

Another strong violation of LSP is when, instead of varying the types of the parameters on the hierarchy, the signatures of the methods differ completely. This might seem like quite a blunder, but detecting it would not always be so easy to remember; Python is interpreted, so there is no compiler to detect these type of error early on, and therefore they will not be caught until runtime. Luckily, we have static code analyzers such as Mypy and Pylint to catch errors such as this one early on.

While Mypy will also catch these type of error, it is not bad to also run Pylint to gain more insight.

In the presence of a class that breaks the compatibility defined by the hierarchy (for example, by changing the signature of the method, adding an extra parameter, and so on) shown as follows:

```
# lsp_1.py
class LogoutEvent(Event):
    def meets_condition(self, event_data: dict, override: bool) -> bool:
        if override:
            return True
        ...
```

Pylint will detect it, printing an informative error:

```
Parameters differ from overridden 'meets_condition' method (arguments-  
differ)
```

Once again, like in the previous case, do not suppress these errors. Pay attention to the warnings and errors the tools give and adapt the code accordingly.

More subtle cases of LSP violations

In other cases, however, the way LSP is broken is not so clear or obvious that a tool can automatically identify it for us, and we have to rely upon careful code inspection when doing a code review.

Cases where contracts are modified are particularly harder to detect automatically. Given that the entire idea of LSP is that subclasses can be used by clients just like their parent class, it must also be true that contracts are correctly preserved on the hierarchy.

Remember from Chapter 3, *General Traits of Good Code*, that, when designing by contract, the contract between the client and supplier sets some rules—the client must provide the preconditions to the method, which the supplier might validate, and it returns some result to the client that it will check in the form of postconditions.

The parent class defines a contract with its clients. Subclasses of this one must respect such a contract. This means that, for example:

- A subclass can never make preconditions stricter than they are defined on the parent class
- A subclass can never make postconditions weaker than they are defined on the parent class

Consider the example of the events hierarchy defined in the previous section, but now with a change to illustrate the relationship between LSP and DbC.

This time, we are going to assume a precondition for the method that checks the criteria based on the data, that the provided parameter must be a dictionary that contains both keys "before" and "after", and that their values are also nested dictionaries. This allows us to encapsulate even further, because now the client does not need to catch the `KeyError` exception, but instead just calls the precondition method (assuming that is acceptable to fail if the system is operating under the wrong assumptions). As a side note, it is good that we can remove this from the client, as now, `SystemMonitor` does not require to know which types of exceptions the methods of the collaborator class might raise (remember that exception weaken encapsulation, as they require the caller to know something extra about the object they are calling).

Such a design might be represented with the following changes in the code:

```
# lsp_2.py

class Event:
    def __init__(self, raw_data):
        self.raw_data = raw_data

    @staticmethod
    def meets_condition(event_data: dict):
        return False

    @staticmethod
    def meets_condition_pre(event_data: dict):
        """Precondition of the contract of this interface.

        Validate that the ``event_data`` parameter is properly formed.
        """
```



```
    assert isinstance(event_data, dict), f"{event_data!r} is not a
dict"
    for moment in ("before", "after"):
        assert moment in event_data, f"{moment} not in {event_data}"
        assert isinstance(event_data[moment], dict)
```

And now the code that tries to detect the correct event type just checks the precondition once, and proceeds to find the right type of event:

```
# lsp_2.py
class SystemMonitor:
    """Identify events that occurred in the system."""

    def __init__(self, event_data):
        self.event_data = event_data

    def identify_event(self):
        Event.meets_condition_pre(self.event_data)
        event_cls = next(
            (
                event_cls
                for event_cls in Event.__subclasses__()
                if event_cls.meets_condition(self.event_data)
            ),
            UnknownEvent,
        )
        return event_cls(self.event_data)
```

The contract only states that the top-level keys "before" and "after" are mandatory and that their values should also be dictionaries. Any attempt in the subclasses to demand a more restrictive parameter will fail.

The class for the transaction event was originally correctly designed. Look at how the code does not impose a restriction on the internal key named "transaction"; it only uses its value if it is there, but this is not mandatory:

```
# lsp_2.py
class TransactionEvent(Event):
    """Represents a transaction that has just occurred on the system."""

    @staticmethod
    def meets_condition(event_data: dict):
        return event_data["after"].get("transaction") is not None
```

However, the original two methods are not correct, because they demand the presence of a key named "session", which is not part of the original contract. This breaks the contract, and now the client cannot use these classes in the same way it uses the rest of them because it will raise `KeyError`.

After fixing this (changing the square brackets for the `.get()` method), the order on the LSP has been reestablished, and polymorphism prevails:

```
>>> l1 = SystemMonitor({"before": {"session": 0}, "after": {"session": 1}})
>>> l1.identify_event().__class__.__name__
'LoginEvent'

>>> l2 = SystemMonitor({"before": {"session": 1}, "after": {"session": 0}})
>>> l2.identify_event().__class__.__name__
'LogoutEvent'

>>> l3 = SystemMonitor({"before": {"session": 1}, "after": {"session": 1}})
>>> l3.identify_event().__class__.__name__
'UnknownEvent'

>>> l4 = SystemMonitor({"before": {}, "after": {"transaction": "Tx001"}})
>>> l4.identify_event().__class__.__name__
'TransactionEvent'
```

It is unreasonable to expect automated tools (regardless of how good and helpful they are), will detect cases such as this one. We have to be careful when designing classes that we do not accidentally change the input or output of the methods in a way that would be incompatible with what the clients are originally expecting.

Remarks on the LSP

The LSP is fundamental to a good object-oriented software design because it emphasizes one of its core traits—polymorphism. It is about creating correct hierarchies so that classes derived from a base one are polymorphic along the parent one, with respect to the methods on their interface.

It is also interesting to notice how this principle relates to the previous one—if we attempt to extend a class with a new one that is incompatible, it will fail, the contract with the client will be broken, and as a result such an extension will not be possible (or, to make it possible, we would have to break the other end of the principle and modify code in the client that should be closed for modification, which is completely undesirable and unacceptable).

Carefully thinking about new classes in the way that LSP suggests helps us to extend the hierarchy correctly. We could then say that LSP contributes to the OCP.

Interface segregation

The **interface segregation principle (ISP)** provides some guidelines over an idea that we have revisited quite repeatedly already: that interfaces should be small.

In object-oriented terms, an **interface** is represented by the set of methods an object exposes. This is to say that all the messages that an object is able to receive or interpret constitute its interface, and this is what other clients can request. The interface separates the definition of the exposed behavior for a class from its implementation.

In Python, interfaces are implicitly defined by a class according to its methods. This is because Python follows the so-called **duck typing** principle.

Traditionally, the idea behind duck typing was that any object is really represented by the methods it has, and by what it is capable of doing. This means that, regardless of the type of the class, its name, its docstring, class attributes, or instance attributes, what ultimately defines the essence of the object are the methods it has. The methods defined on a class (what it knows how to do) are what determines what that object will actually be. It was called duck typing because of the idea that "If it walks like a duck, and quacks like a duck, it must be a duck."

For a long time, duck typing was the sole way interfaces were defined in Python. Later on, Python 3 (PEP-3119) introduced the concept of abstract base classes as a way to define interfaces in a different way. The basic idea of abstract base classes is that they define a basic behavior or interface that some derived classes are responsible for implementing. This is useful in situations where we want to make sure that certain critical methods are actually overridden, and it also works as a mechanism for overriding or extending the functionality of methods such as `isinstance()`.

This module also contains a way of registering some types as part of a hierarchy, in what is called a **virtual subclass**. The idea is that this extends the concept of duck typing a little bit further by adding a new criterion—walks like a duck, quacks like a duck, or... it says it is a duck.

These notions of how Python interprets interfaces are important for understanding this principle and the next one.

In abstract terms, this means that the ISP states that, when we define an interface that provides multiple methods, it is better to instead break it down into multiple ones, each one containing fewer methods (preferably just one), with a very specific and accurate scope. By separating interfaces into the smallest possible units, to favor code reusability, each class that wants to implement one of these interfaces will most likely be highly cohesive given that it has a quite definite behavior and set of responsibilities.

An interface that provides too much

Now, we want to be able to parse an event from several data sources, in different formats (XML and JSON, for instance). Following good practice, we decide to target an interface as our dependency instead of a concrete class, and something like the following is devised:



In order to create this as an interface in Python, we would use an abstract base class and define the methods (`from_xml()` and `from_json()`) as abstract, to force derived classes to implement them. Events that derive from this abstract base class and implement these methods would be able to work with their corresponding types.

But what if a particular class does not need the XML method, and can only be constructed from a JSON? It would still carry the `from_xml()` method from the interface, and since it does not need it, it will have to pass. This is not very flexible as it creates coupling and forces clients of the interface to work with methods that they do not need.

The smaller the interface, the better

It would be better to separate this into two different interfaces, one for each method:



With this design, objects that derive from `XMLEventParser` and implement the `from_xml()` method will know how to be constructed from an XML, and the same for a JSON file, but most importantly, we maintain the orthogonality of two independent functions, and preserve the flexibility of the system without losing any functionality that can still be achieved by composing new smaller objects.

There is some resemblance to the SRP, but the main difference is that here we are talking about interfaces, so it is an abstract definition of behavior. There is no reason to change because there is nothing there until the interface is actually implemented. However, failure to comply with this principle will create an interface that will be coupled with orthogonal functionality, and this derived class will also fail to comply with the SRP (it will have more than one reason to change).

How small should an interface be?

The point made in the previous section is valid, but it also needs a warning—avoid a dangerous path if it's misunderstood or taken to the extreme.

A base class (abstract or not) defines an interface for all the other classes to extend it. The fact that this should be as small as possible has to be understood in terms of cohesion—it should do one thing. That doesn't mean it must necessarily have one method. In the previous example, it was by coincidence that both methods were doing totally disjoint things, hence it made sense to separate them into different classes.

But it could be the case that more than one method rightfully belongs to the same class. Imagine that you want to provide a mixin class that abstracts certain logic in a context manager so that all classes derived from that mixin gain that context manager logic for free. As we already know, a context manager entails two methods: `__enter__` and `__exit__`. They must go together, or the outcome will not be a valid context manager at all!

Failure to place both methods in the same class will result in a broken component that is not only useless, but also misleadingly dangerous. Hopefully, this exaggerated example works as a counter-balance to the one in the previous section, and together the reader can get a more accurate picture about designing interfaces.

Dependency inversion

This is a really powerful idea that will come up again later when we explore some design patterns in [Chapter 9, *Common Design Patterns*](#), and [Chapter 10, *Clean Architecture*](#).

The **dependency inversion principle (DIP)** proposes an interesting design principle by which we protect our code by making it independent of things that are fragile, volatile, or out of our control. The idea of inverting dependencies is that our code should not adapt to details or concrete implementations, but rather the other way around: we want to force whatever implementation or detail to adapt to our code via a sort of API.

Abstractions have to be organized in such a way that they do not depend on details, but rather the other way around—the details (concrete implementations) should depend on abstractions.

Imagine that two objects in our design need to collaborate, *A* and *B*. *A* works with an instance of *B*, but as it turns out, our module doesn't control *B* directly (it might be an external library, or a module maintained by another team, and so on). If our code heavily depends on *B*, when this changes the code will break. To prevent this, we have to invert the dependency: make *B* have to adapt to *A*. This is done by presenting an interface and forcing our code not to depend on the concrete implementation of *B*, but rather on the interface we have defined. It is then *B*'s responsibility to comply with that interface.

In line with the concepts explored in previous sections, abstractions also come in the form of interfaces (or abstract base classes in Python).

In general, we could expect concrete implementations to change much more frequently than abstract components. It is for this reason that we place abstractions (interfaces) as flexibility points where we expect our system to change, be modified, or extended without the abstraction itself having to be changed.

A case of rigid dependencies

The last part of our event's monitoring system is to deliver the identified events to a data collector to be further analyzed. A naive implementation of such an idea would consist of having an event streamer class that interacts with a data destination, for example, `Syslog`:

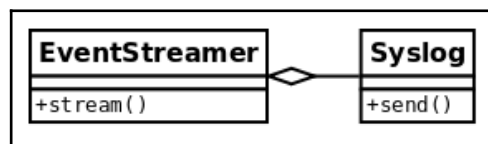

However, this design is not very good, because we have a high-level class (`EventStreamer`) depending on a low-level one (`Syslog` is an implementation detail). If something changes in the way we want to send data to `Syslog`, `EventStreamer` will have to be modified. If we want to change the data destination for a different one or add new ones at runtime, we are also in trouble because we will find ourselves constantly modifying the `stream()` method to adapt it to these requirements.

Inverting the dependencies

The solution to these problems is to make `EventStreamer` work with an interface, rather than a concrete class. This way, implementing this interface is up to the low-level classes that contain the implementation details:

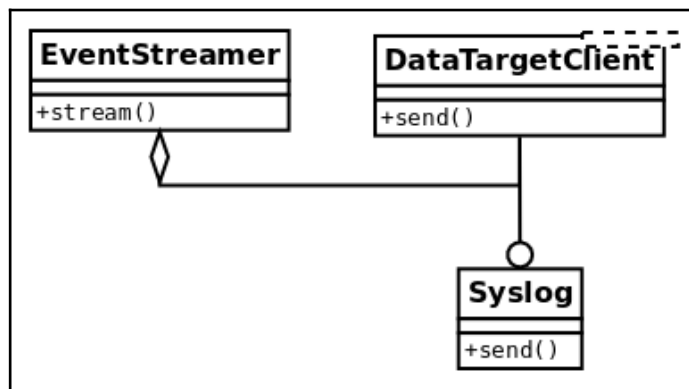

Now there is an interface that represents a generic data target where data is going to be sent to. Notice how the dependencies have now been inverted since `EventStreamer` does not depend on a concrete implementation of a particular data target, it does not have to change in line with changes on this one, and it is up to every particular data target; to implement the interface correctly and adapt to changes if necessary.

In other words, the original `EventStreamer` of the first implementation only worked with objects of type `Syslog`, which was not very flexible. Then we realized that it could work with any object that could respond to a `.send()` message, and identified this method as the interface that it needed to comply with. Now, in this version, `Syslog` is actually extending the abstract base class named `DataTargetClient`, which defines the `send()` method. From now on, it is up to every new type of data target (email, for instance) to extend this abstract base class and implement the `send()` method.

We can even modify this property at runtime for any other object that implements a `send()` method, and it will still work. This is the reason why it is often called **dependency injection**: because the dependency can be provided dynamically.

The avid reader might be wondering why this is actually necessary. Python is flexible enough (sometimes too flexible), and will allow us to provide an object like `EventStreamer` with any particular data target object, without this one having to comply with any interface because it is dynamically typed. The question is this: why do we need to define the abstract base class (interface) at all when we can simply pass an object with a `send()` method to it?

In all fairness, this is true; there is actually no need to do that, and the program will work just the same. After all, polymorphism does not mean (or require) inheritance to work. However, defining the abstract base class is a good practice that comes with some advantages, the first one being duck typing. Together with as duck typing, we can mention the fact that the models become more readable—remember that inheritance follows the rule of **is a**, so by declaring the abstract base class and extending from it, we are saying that, for instance, `Syslog` is `DataTargetClient`, which is something users of your code can read and understand (again, this is duck typing).

All in all, it is not mandatory to define the abstract base class, but it is desirable in order to achieve a cleaner design. This is one of the things this book is for—to help programmers avoid easy-to-make mistakes, just because Python is too flexible and we can get away with it.

Summary

The SOLID principles are key guidelines for good object-oriented software design.

Building software is an incredibly hard task—the logic of the code is complex, its behavior at runtime is hard (if even possible, sometimes) to predict, requirements change constantly as well as the environment, and there are multiple things that can go wrong.

In addition, there are multiple ways of constructing software with different techniques, paradigms, and a lot of different designs, which can work together to solve a particular problem in a specific manner. However, not all of these approaches will prove to be correct as time passes, and requirements change or evolve. However, by this time, it will already be too late to do something about an incorrect design, as it is rigid, inflexible, and therefore hard to change a refactor into the proper solution.

This means that, if we get the design wrong, it will cost us a lot in the future. How can we then achieve a good design that will eventually pay off? The answer is that we do not know for sure. We are dealing with the future, and the future is uncertain—there is no way to determine if our design will be correct and if our software will be flexible and adaptable in years to come. It is precisely for that reason that we have to stick to principles.

This is where the SOLID principles come into play. They are not a magic rule (after all, there are no silver bullets in software engineering), but they provide good guidelines to follow that have been proven to work in past projects and will make our software much more likely to succeed.

In this chapter, we have explored the SOLID principles with the goal of understanding clean design. In the following chapters, we will continue to explore details of the language, and see in some cases how these tools and features can be used with these principles.

References

Here is a list of information you may refer to:

- *SRP 01: The Single Responsibility Principle* (<https://8thlight.com/blog/uncle-bob/2014/05/08/SingleResponsibilityPrinciple.html>)
- *PEP-3119: Introducing Abstract Base Classes* (<https://www.python.org/dev/peps/pep-3119/>)
- *LISKOV 01: A paper written by Barbara Liskov named *Data Abstraction and Hierarchy**

5

Using Decorators to Improve Our Code

In this chapter, we will explore decorators and see how they are useful in many situations where we want to improve our design. We will start by first exploring what decorators are, how they work, and how they are implemented.

With this knowledge, we will then revisit concepts that we learned in previous chapters regarding general good practices for software design, and see how decorators can help us comply with each principle.

The goals of this chapter are as follows:

- To understand how decorators work in Python
- To learn how to implement decorators that apply to functions and classes
- To effectively implement decorators, avoiding common implementation mistakes
- To analyze how to avoid code duplication (the DRY principle) with decorators
- To study how decorators contribute to separation of concerns
- To analyze examples of good decorators
- To review common situations, idioms, or patterns for when decorators are the right choice

What are decorators in Python?

Decorators were introduced in Python a long time ago, in (PEP-318), as a mechanism to simplify the way functions and methods are defined when they have to be modified after their original definition.

One of the original motivations for this was because functions such as `classmethod` and `staticmethod` were used to transform the original definition of the method, but they required an extra line, modifying the original definition of the function.

More generally speaking, every time we had to apply a transformation to a function, we had to call it with the `modifier` function, and then reassign it to the same name the function was originally defined with.

For instance, if we have a function called `original`, and then we have a function that changes the behavior of `original` on top of it, called `modifier`, we have to write something like the following:

```
def original(...):  
    ...  
    original = modifier(original)
```

Notice how we change the function and reassign it to the same name. This is confusing, error-prone (imagine that someone forgets to reassign the function, or does reassign that but not in the line immediately after the function definition, but much farther away), and cumbersome. For this reason, some syntax support was added to the language.

The previous example could be rewritten like so:

```
@modifier  
def original(...):  
    ...
```

This means that decorators are just syntax sugar for calling whatever is after the decorator as a first parameter of the decorator itself, and the result would be whatever the decorator returns.

In line with the Python terminology, and our example, `modifier` is what we call the decorator, and `original` is the decorated function, often also called a **wrapped** object.

While the functionality was originally thought for methods and functions, the actual syntax allows any kind of object to be decorated, so we are going to explore decorators applied to functions, methods, generators, and classes.

One final note is that, while the name of a decorator is correct (after all, the decorator is in fact, making changes, extending, or working on top of the `wrapped` function), it is not to be confused with the decorator design pattern.

Decorate functions

Functions are probably the simplest representation of a Python object that can be decorated. We can use decorators on functions to apply all sorts of logic to them—we can validate parameters, check preconditions, change the behavior entirely, modify its signature, cache results (create a memorized version of the original function), and more.

As an example, we will create a basic decorator that implements a `retry` mechanism, controlling a particular domain-level exception and retrying a certain number of times:

```
# decorator_function_1.py
class ControlledException(Exception):
    """A generic exception on the program's domain."""

def retry(operation):
    @wraps(operation)
    def wrapped(*args, **kwargs):
        last_raised = None
        RETRIES_LIMIT = 3
        for _ in range(RETRIES_LIMIT):
            try:
                return operation(*args, **kwargs)
            except ControlledException as e:
                logger.info("retrying %s", operation.__qualname__)
                last_raised = e
        raise last_raised

    return wrapped
```

The use of `@wraps` can be ignored for now, as it will be covered in the section named *Effective decorators - avoiding common mistakes*. The use of `_` in the for loop, means that the number is assigned to a variable we are not interested in at the moment, because it's not used inside the for loop (it's a common idiom in Python to name `_` values that are ignored).

The `retry` decorator doesn't take any parameters, so it can be easily applied to any function, as follows:

```
@retry
def run_operation(task):
    """Run a particular task, simulating some failures on its execution."""
    return task.run()
```

As explained at the beginning, the definition of `@retry` on top of `run_operation` is just syntactic sugar that Python provides to actually execute `run_operation = retry(run_operation)`.

In this limited example, we can see how decorators can be used to create a generic `retry` operation that, under certain conditions (in this case, represented as exceptions that could be related to timeouts, for example), will allow calling the decorated code multiple times.

Decorate classes

Classes can also be decorated (PEP-3129) with the same as can be applied to syntax functions. The only difference is that when writing the code for this decorator, we have to take into consideration that we are receiving a class, not a function.

Some practitioners might argue that decorating a class is something rather convoluted and that such a scenario might jeopardize readability because we would be declaring some attributes and methods in the class, but behind the scenes, the decorator might be applying changes that would render a completely different class.

This assessment is true, but only if this technique is heavily abused. Objectively, this is no different from decorating functions; after all, classes are just another type of object in the Python ecosystem, as functions are. We will review the pros and cons of this issue with decorators in the section titled *Decorators and separation of concerns*, but for now, we'll explore the benefits of decorators that apply particularly to classes:

- All the benefits of reusing code and the DRY principle. A valid case of a class decorator would be to enforce that multiple classes conform to a certain interface or criteria (by making this checks only once in the decorator that is going to be applied to those many classes).
- We could create smaller or simpler classes that will be enhanced later on by decorators
- The transformation logic we need to apply to a certain class will be much easier to maintain if we use a decorator, as opposed to more complicated (and often rightfully discouraged) approaches such as metaclasses

Among all possible applications of decorators, we will explore a simple example to give an idea of the sorts of things they can be useful for. Keep in mind that this is not the only application type for class decorators, but also that the code we show you could have many other multiple solutions as well, all with their pros and cons, but we chose decorators with the purpose of illustrating their usefulness.

Recalling our event systems for the monitoring platform, we now need to transform the data for each event and send it to an external system. However, each type of event might have its own particularities when selecting how to send its data.

In particular, the `event` for a login might contain sensitive information such as credentials that we want to hide. Other fields such as `timestamp` might also require some transformations since we want to show them in a particular format. A first attempt at complying with these requirements would be as simple as having a class that maps to each particular `event` and knows how to serialize it:

```
class LoginEventSerializer:
    def __init__(self, event):
        self.event = event

    def serialize(self) -> dict:
        return {
            "username": self.event.username,
            "password": "***redacted**",
            "ip": self.event.ip,
            "timestamp": self.event.timestamp.strftime("%Y-%m-%d
                %H:%M"),
        }

class LoginEvent:
    SERIALIZER = LoginEventSerializer

    def __init__(self, username, password, ip, timestamp):
        self.username = username
        self.password = password
        self.ip = ip
        self.timestamp = timestamp

    def serialize(self) -> dict:
        return self.SERIALIZER(self).serialize()
```

Here, we declare a class that is going to map directly with the login event, containing the logic for it—hide the `password` field, and format the `timestamp` as required.

While this works and might look like a good option to start with, as time passes and we want to extend our system, we will find some issues:

- **Too many classes:** As the number of events grows, the number of serialization classes will grow in the same order of magnitude, because they are mapped one to one.

- **The solution is not flexible enough:** If we need to reuse parts of the components (for example, we need to hide the `password` in another type of `event` that also has it), we will have to extract this into a function, but also call it repeatedly from multiple classes, meaning that we are not reusing that much code after all.
- **Boilerplate:** The `serialize()` method will have to be present in all `event` classes, calling the same code. Although we can extract this into another class (creating a mixin), it does not seem like a good use of inheritance.

An alternative solution is to be able to dynamically construct an object that, given a set of filters (transformation functions) and an `event` instance, is able to serialize it by applying the filters to its fields. We then only need to define the functions to transform each type of field, and the serializer is created by composing many of these functions.

Once we have this object, we can decorate the class in order to add the `serialize()` method, which will just call these `Serialization` objects with itself:

```
def hide_field(field) -> str:
    return "***redacted**"

def format_time(field_timestamp: datetime) -> str:
    return field_timestamp.strftime("%Y-%m-%d %H:%M")

def show_original(event_field):
    return event_field

class EventSerializer:
    def __init__(self, serialization_fields: dict) -> None:
        self.serialization_fields = serialization_fields

    def serialize(self, event) -> dict:
        return {
            field: transformation(getattr(event, field))
            for field, transformation in
            self.serialization_fields.items()
        }

class Serialization:
    def __init__(self, **transformations):
        self.serializer = EventSerializer(transformations)

    def __call__(self, event_class):
        def serialize_method(event_instance):
```

```
        return self.serializer.serialize(event_instance)
    event_class.serialize = serialize_method
    return event_class

@Serialization(
    username=show_original,
    password=hide_field,
    ip=show_original,
    timestamp=format_time,
)
class LoginEvent:

    def __init__(self, username, password, ip, timestamp):
        self.username = username
        self.password = password
        self.ip = ip
        self.timestamp = timestamp
```

Notice how the decorator makes it easier for the user to know how each field is going to be treated without having to look into the code of another class. Just by reading the arguments passed to the class decorator, we know that the `username` and IP address will be left unmodified, the `password` will be hidden, and the `timestamp` will be formatted.

Now, the code of the class does not need the `serialize()` method defined, nor does it need to extend from a mixin that implements it, since the decorator will add it. In fact, this is probably the only part that justifies the creation of the class decorator, because otherwise, the `Serialization` object could have been a class attribute of `LoginEvent`, but the fact that it is altering the class by adding a new method to it makes it impossible.

Moreover, we could have another class decorator that, just by defining the attributes of the class, implements the logic of the `init` method, but this is beyond the scope of this example. This is what libraries such as `attrs` (ATRS 01) do, and a similar functionality is proposed in (PEP-557) for the Standard library.

By using this class decorator from (PEP-557), in Python 3.7+, the previous example could be rewritten in a more compact way, without the boilerplate code of the `init`, as shown here:

```
from dataclasses import dataclass
from datetime import datetime

@Serialization(
    username=show_original,
    password=hide_field,
    ip=show_original,
    timestamp=format_time,
```



```
)  
@dataclass  
class LoginEvent:  
    username: str  
    password: str  
    ip: str  
    timestamp: datetime
```

Other types of decorator

Now that we know what the `@` syntax for decorators actually means, we can conclude that it isn't just functions, methods, or classes that can be decorated; actually, anything that can be defined, such as generators, coroutines, and even objects that have already been decorated, can be decorated, meaning that decorators can be stacked.

The previous example showed how decorators can be chained. We first defined the class, and then applied `@dataclass` to it, which converted it into a data class, acting as a container for those attributes. After that, the `@Serialization` will apply the logic to that class, resulting in a new class with the new `serialize()` method added to it.

Another good use of decorators is for generators that are supposed to be used as coroutines. We will explore the details of generators and coroutines in [Chapter 7, Using Generators](#), but the main idea is that, before sending any data to a newly created generator, the latter has to be advanced up to their next `yield` statement by calling `next()` on it. This is a manual process that every user will have to remember and hence is error-prone. We could easily create a decorator that takes a generator as a parameter, calls `next()` to it, and then returns the generator.

Passing arguments to decorators

At this point, we already regard decorators as a powerful tool in Python. However, they could be even more powerful if we could just pass parameters to them so that their logic is abstracted even more.

There are several ways of implementing decorators that can take arguments, but we will go over the most common ones. The first one is to create decorators as nested functions with a new level of indirection, making everything in the decorator fall one level deeper. The second approach is to use a class for the decorator.

In general, the second approach favors readability more, because it is easier to think in terms of an object than three or more nested functions working with closures. However, for completeness, we will explore both, and the reader can decide what is best for the problem at hand.

Decorators with nested functions

Roughly speaking, the general idea of a decorator is to create a function that returns a function (often called a higher-order function). The internal function defined in the body of the decorator is going to be the one actually being called.

Now, if we wish to pass parameters to it, we then need another level of indirection. The first one will take the parameters, and inside that function, we will define a new function, which will be the decorator, which in turn will define yet another new function, namely the one to be returned as a result of the decoration process. This means that we will have at least three levels of nested functions.

Don't worry if this didn't seem clear so far. After reviewing the examples that are about to come, everything will become clear.

One of the first examples we saw of decorators implemented the `retry` functionality over some functions. This is a good idea, except it has a problem; our implementation did not allow us to specify the numbers of retries, and instead, this was a fixed number inside the decorator.

Now, we want to be able to indicate how many retries each instance is going to have, and perhaps we could even add a default value to this parameter. In order to do this, we need another level of nested functions—first for the parameters, and then for the decorator itself.

This is because we are now going to have something in the form of the following:

```
@retry(arg1, arg2, ... )
```

And that has to return a decorator because the `@` syntax will apply the result of that computation to the object to be decorated. Semantically, it would translate to something like the following:

```
<original_function> = retry(arg1, arg2, ...)(<original_function>)
```

Besides the number of desired retries, we can also indicate the types of exception we wish to control. The new version of the code supporting the new requirements might look like this:

```
RETRIES_LIMIT = 3

def with_retry(retries_limit=RETRIES_LIMIT, allowed_exceptions=None):
    allowed_exceptions = allowed_exceptions or (ControlledException,)

    def retry(operation):

        @wraps(operation)
        def wrapped(*args, **kwargs):
            last_raised = None
            for _ in range(retries_limit):
                try:
                    return operation(*args, **kwargs)
                except allowed_exceptions as e:
                    logger.info("retrying %s due to %s", operation, e)
                    last_raised = e
            raise last_raised

        return wrapped

    return retry
```

Here are some examples of how this decorator can be applied to functions, showing the different options it accepts:

```
# decorator_parametrized_1.py
@with_retry()
def run_operation(task):
    return task.run()

@with_retry(retries_limit=5)
def run_with_custom_retries_limit(task):
    return task.run()

@with_retry(allowed_exceptions=(AttributeError,))
def run_with_custom_exceptions(task):
    return task.run()

@with_retry(
    retries_limit=4, allowed_exceptions=(ZeroDivisionError, AttributeError)
```

```
)  
def run_with_custom_parameters(task):  
    return task.run()
```

Decorator objects

The previous example requires three levels of nested functions. The first it is going to be a function that receives the parameters of the decorator we want to use. Inside this function, the rest of the functions are closures that use these parameters along with the logic of the decorator.

A cleaner implementation of this would be to use a class to define the decorator. In this case, we can pass the parameters in the `__init__` method, and then implement the logic of the decorator on the magic method named `__call__`.

The code for the decorator will look like it does in the following example:

```
class WithRetry:  
  
    def __init__(self, retries_limit=RETRIES_LIMIT,  
allowed_exceptions=None):  
        self.retries_limit = retries_limit  
        self.allowed_exceptions = allowed_exceptions or  
(ControlledException,)  
  
    def __call__(self, operation):  
  
        @wraps(operation)  
        def wrapped(*args, **kwargs):  
            last_raised = None  
  
            for _ in range(self.retries_limit):  
                try:  
                    return operation(*args, **kwargs)  
                except self.allowed_exceptions as e:  
                    logger.info("retrying %s due to %s", operation, e)  
                    last_raised = e  
            raise last_raised  
  
        return wrapped
```

And this decorator can be applied pretty much like the previous one, like so:

```
@WithRetry(retries_limit=5)  
def run_with_custom_retries_limit(task):  
    return task.run()
```

It is important to note how the Python syntax takes effect here. First, we create the object, so before the `@` operation is applied, the object is created with its parameters passed to it. This will create a new object and initialize it with these parameters, as defined in the `init` method. After this, the `@` operation is invoked, so this object will wrap the function named `run_with_custom_retries_limit`, meaning that it will be passed to the `call` magic method.

Inside this `call` magic method, we defined the logic of the decorator as we normally do—we wrap the original function, returning a new one with the logic we want instead.

Good uses for decorators

In this section, we will take a look at some common patterns that make good use of decorators. These are common situations for when decorators are a good choice.

From all the countless applications decorators can be used for, we will enumerate a few, the most common or relevant:

- **Transforming parameters:** Changing the signature of a function to expose a nicer API, while encapsulating details on how the parameters are treated and transformed underneath
- **Tracing code:** Logging the execution of a function with its parameters
- **Validate parameters**
- **Implement retry operations**
- **Simplify classes by moving some (repetitive) logic into decorators**

Let's discuss the first two applications in detail in the following section.

Transforming parameters

We have mentioned before that decorators can be used to validate parameters (and even enforce some preconditions or postconditions under the idea of DbC), so from this you probably have got the idea that it is somehow common to use decorators when dealing with or manipulating parameters.

In particular, there are some cases on which we find ourselves repeatedly creating similar objects, or applying similar transformations that we would wish to abstract away. Most of the time, we can achieve this by simply using a decorator.

Tracing code

When talking about **tracing** in this section, we will refer to something more general that has to do with dealing with the execution of a function that we wish to monitor. This could refer to scenarios in which we want to:

- Actually trace the execution of a function (for example, by logging the lines it executes)
- Monitor some metrics over a function (such as CPU usage or memory footprint)
- Measure the running time of a function
- Log when a function was called, and the parameters that were passed to it

In the next section, we will explore a simple example of a decorator that logs the execution of a function, including its name and the time it took to run.

Effective decorators – avoiding common mistakes

While decorators are a great feature of Python, they are not exempt from issues if used incorrectly. In this section, we will see some common issues to avoid in order to create effective decorators.

Preserving data about the original wrapped object

One of the most common problems when applying a decorator to a function is that some of the properties or attributes of the original function are not maintained, leading to undesired, and hard-to-track, side-effects.

To illustrate this we show a decorator that is in charge of logging when the function is about to run:

```
# decorator_wraps_1.py

def trace_decorator(function):
    def wrapped(*args, **kwargs):
        logger.info("running %s", function.__qualname__)
        return function(*args, **kwargs)

    return wrapped
```

Now, let's imagine we have a function with this decorator applied to it. We might initially think that nothing of that function is modified with respect to its original definition:

```
@trace_decorator
def process_account(account_id):
    """Process an account by Id."""
    logger.info("processing account %s", account_id)
    ...
```

But maybe there are changes.

The decorator is not supposed to alter anything from the original function, but, as it turns out since it contains a flaw it's actually modifying its name and `docstring`, among other properties.

Let's try to get `help` for this function:

```
>>> help(process_account)
Help on function wrapped in module decorator_wraps_1:

wrapped(*args, **kwargs)
```

And let's check how it's called:

```
>>> process_account.__qualname__
'trace_decorator.<locals>.wrapped'
```

We can see that, since the decorator is actually changing the original function for a new one (called `wrapped`), what we actually see are the properties of this function instead of those from the original function.

If we apply a decorator like this one to multiple functions, all with different names, they will all end up being called `wrapped`, which is a major concern (for example, if we want to log or trace the function, this will make debugging even harder).

Another problem is that, in case we placed docstrings with tests on these functions, they will be overridden by those of the decorator. As a result, the docstrings with the test we want will not run when we call our code with the `doctest` module (as we have seen in Chapter 1, *Introduction, Code Formatting, and Tools*).

The fix is simple, though. We just have to apply the `wraps` decorator in the internal function (`wrapped`), telling it that it is actually wrapping function:

```
# decorator_wraps_2.py
def trace_decorator(function):
    @wraps(function)
    def wrapped(*args, **kwargs):
        logger.info("running %s", function.__qualname__)
        return function(*args, **kwargs)

    return wrapped
```

Now, if we check the properties, we will obtain what we expected in the first place. Check `help` for the function, like so:

```
>>> Help on function process_account in module decorator_wraps_2:

process_account(account_id)
    Process an account by Id.
```

And verify that its qualified name is correct, like so:

```
>>> process_account.__qualname__
'process_account'
```

Most importantly, we recovered the unit tests we might have had on the docstrings! By using the `wraps` decorator, we can also access the original, unmodified function under the `__wrapped__` attribute. Although it should not be used in production, it might come in handy in some unit tests when we want to check the unmodified version of the function.

In general, for simple decorators, the way we would use `functools.wraps` would typically follow the general formula or structure:

```
def decorator(original_function):
    @wraps(original_function)
    def decorated_function(*args, **kwargs):
        # modifications done by the decorator ...
        return original_function(*args, **kwargs)

    return decorated_function
```



Always use `functools.wraps` applied over the wrapped function, when creating a decorator, as shown in the preceding formula.

Dealing with side-effects in decorators

In this section, we will learn that it is advisable to avoid side-effects in the body of the decorator. There are cases where this might be acceptable, but the bottom line is that, if in case of doubt, decide against it, for the reasons that are explained ahead. Everything that the decorator needs to do aside from the function that it's decorating should be placed in the innermost function definition, or there will be problems when it comes to importing.

Nonetheless, sometimes these side-effects are required (or even desired) to run at import time, and the obverse applies.

We will see examples of both, and where each one applies. If in doubt, err on the side of caution, and delay all side-effects until the very latest, right after the `wrapped` function is going to be called.

Next, we will see when it's not a good idea to place extra logic outside the `wrapped` function.

Incorrect handling of side-effects in a decorator

Let's imagine the case of a decorator that was created with the goal of logging when a function started running and then logging its running time:

```
def traced_function_wrong(function):
    logger.info("started execution of %s", function)
    start_time = time.time()

    @functools.wraps(function)
    def wrapped(*args, **kwargs):
        result = function(*args, **kwargs)
        logger.info(
            "function %s took %.2fs",
            function,
            time.time() - start_time
        )
        return result
    return wrapped
```

Now we will apply the decorator to a regular function, thinking that it will work just fine:

```
@traced_function_wrong
def process_with_delay(callback, delay=0):
    time.sleep(delay)
    return callback()
```

This decorator has a subtle, yet critical bug in it.

First, let's import the function, call it several times, and see what happens:

```
>>> from decorator_side_effects_1 import process_with_delay
INFO:started execution of <function process_with_delay at 0x...>
```

Just by importing the function, we will notice that something's amiss. The logging line should not be there, because the function was not invoked.

Now, what happens if we run the function, and see how long it takes to run? Actually, we would expect that calling the same function multiple times will give similar results:

```
>>> main()
...
INFO:function <function process_with_delay at 0x> took 8.67s

>>> main()
...
INFO:function <function process_with_delay at 0x> took 13.39s

>>> main()
...
INFO:function <function process_with_delay at 0x> took 17.01s
```

Every time we run the same function, it takes longer! At this point, you have probably already noticed the (now obvious) error.

Remember the syntax for decorators. `@traced_function_wrong` actually means the following:

```
process_with_delay = traced_function_wrong(process_with_delay)
```

And this will run when the module is imported. Therefore, the time that is set in the function will be the one at the time the module was imported. Successive calls will compute the time difference from the running time until that original starting time. It will also log at the wrong moment, and not when the function is actually called.

Luckily, the fix is also very simple—we just have to move the code inside the wrapped function in order to delay its execution:

```
def traced_function(function):
    @functools.wraps(function)
    def wrapped(*args, **kwargs):
        logger.info("started execution of %s", function.__qualname__)
        start_time = time.time()
        result = function(*args, **kwargs)
        logger.info(
            "function %s took %.2fs",
            function.__qualname__,
            time.time() - start_time
        )
        return result
    return wrapped
```

With this new version, the previous problems are resolved.

If the actions of the decorator had been different, the results could have been much more disastrous. For instance, if it requires that you log events and send them to an external service, it will certainly fail unless the configuration has been run right before this has been imported, which we cannot guarantee. Even if we could, it would be bad practice. The same applies if the decorator has any other sort of side-effect, such as reading from a file, parsing a configuration, and many more.

Requiring decorators with side-effects

Sometimes, side-effects on decorators are necessary, and we should not delay their execution until the very last possible time, because that's part of the mechanism which is required for them to work.

One common scenario for when we don't want to delay the side-effect of decorators is when we need to register objects to a public registry that will be available in the module.

For instance, going back to our previous `event` system example, we now want to only make some events available in the module, but not all of them. In the hierarchy of events, we might want to have some intermediate classes that are not actual events we want to process on the system, but some of their derivative classes instead.

Instead of flagging each class based on whether it's going to be processed or not, we could explicitly register each class through a decorator.

In this case, we have a class for all events that relate to the activities of a user. However, this is just an intermediate table for the types of event we actually want, namely `UserLoginEvent` and `UserLogoutEvent`:

```
EVENTS_REGISTRY = {}

def register_event(event_cls):
    """Place the class for the event into the registry to make it
    accessible in
    the module.
    """
    EVENTS_REGISTRY[event_cls.__name__] = event_cls
    return event_cls

class Event:
    """A base event object"""

class UserEvent:
    TYPE = "user"

@register_event
class UserLoginEvent(UserEvent):
    """Represents the event of a user when it has just accessed the
    system."""

@register_event
class UserLogoutEvent(UserEvent):
    """Event triggered right after a user abandoned the system."""
```

When we look at the preceding code, it seems that `EVENTS_REGISTRY` is empty, but after importing something from this module, it will get populated with all of the classes that are under the `register_event` decorator:

```
>>> from decorator_side_effects_2 import EVENTS_REGISTRY
>>> EVENTS_REGISTRY
{'UserLoginEvent': decorator_side_effects_2.UserLoginEvent,
 'UserLogoutEvent': decorator_side_effects_2.UserLogoutEvent}
```

This might seem like it's hard to read, or even misleading, because `EVENTS_REGISTRY` will have its final value at runtime, right after the module was imported, and we cannot easily predict its value by just looking at the code.

While that is true, in some cases this pattern is justified. In fact, many web frameworks or well-known libraries use this to work and expose objects or make them available.

It is also true that in this case, the decorator is not changing the `wrapped` object, nor altering the way it works in any way. However, the important note here is that, if we were to do some modifications and define an internal function that modifies the `wrapped` object, we would still probably want the code that registers the resulting object outside it.

Notice the use of the word *outside*. It does not necessarily mean before, it's just not part of the same closure; but it's in the outer scope, so it's not delayed until runtime.

Creating decorators that will always work

There are several different scenarios to which decorators might apply. It can also be the case that we need to use the same decorator for objects that fall into these different multiple scenarios, for instance, if we want to reuse our decorator and apply it to a function, a class, a method, or a static method.

If we create the decorator, just thinking about supporting only the first type of object we want to decorate, we might notice that the same decorator does not work equally well on a different type of object. The typical example is where we create a decorator to be used on a function, and then we want to apply it to a method of a class, only to realize that it does not work. A similar scenario might occur if we designed our decorator for a method, and then we want it to also apply for static methods or class methods.

When designing decorators, we typically think about reusing code, so we will want to use that decorator for functions and methods as well.

Defining our decorators with the signature `*args`, and `**kwargs`, will make them work in all cases, because it's the most generic kind of signature that we can have. However, sometimes we might want not to use this, and instead define the decorator wrapping function according to the signature of the original function, mainly because of two reasons:

- It will be more readable since it resembles the original function.
- It actually needs to do something with the arguments, so receiving `*args` and `**kwargs` wouldn't be convenient.

Consider the case on which we have many functions in our code base that require a particular object to be created from a parameter. For instance, we pass a string, and initialize a driver object with it, repeatedly. Then we think we can remove the duplication by using a decorator that will take care of converting this parameter accordingly.

In the next example, we pretend that `DBDriver` is an object that knows how to connect and run operations on a database, but it needs a connection string. The methods we have in our code, are designed to receive a string with the information of the database and require to create an instance of `DBDriver` always. The idea of the decorator is that it's going to take place of this conversion automatically—the function will continue to receive a string, but the decorator will create a `DBDriver` and pass it to the function, so internally we can assume that we receive the object we need directly.

An example of using this in a function is shown in the next listing:

```
import logging
from functools import wraps

logger = logging.getLogger(__name__)

class DBDriver:
    def __init__(self, dbstring):
        self.dbstring = dbstring

    def execute(self, query):
        return f"query {query} at {self.dbstring}"

def inject_db_driver(function):
    """This decorator converts the parameter by creating a ``DBDriver``
    instance from the database dsn string.
    """
    @wraps(function)
    def wrapped(dbstring):
        return function(DBDriver(dbstring))
    return wrapped

@inject_db_driver
def run_query(driver):
    return driver.execute("test_function")
```

It's easy to verify that if we pass a string to the function, we get the result done by an instance of `DBDriver`, so the decorator works as expected:

```
>>> run_query("test_OK")
'query test_function at test_OK'
```

But now, we want to reuse this same decorator in a class method, where we find the same problem:

```
class DataHandler:
    @inject_db_driver
    def run_query(self, driver):
        return driver.execute(self.__class__.__name__)
```

We try to use this decorator, only to realize that it doesn't work:

```
>>> DataHandler().run_query("test_fails")
Traceback (most recent call last):
...
TypeError: wrapped() takes 1 positional argument but 2 were given
```

What is the problem?

The method in the class is defined with an extra argument—`self`.

Methods are just a particular kind of function that receives `self` (the object they're defined upon) as the first parameter.

Therefore, in this case, the decorator (designed to work with only one parameter, named `dbstring`), will interpret that `self` is said parameter, and call the method passing the string in the place of `self`, and nothing in the place for the second parameter, namely the string we are passing.

To fix this issue, we need to create a decorator that will work equally for methods and functions, and we do so by defining this as a decorator object, that also implements the protocol descriptor.

Descriptors are fully explained in [Chapter 7, *Using Generators*](#), so, for now, we can just take this as a recipe that will make the decorator work.

The solution is to implement the decorator as a class object and make this object a description, by implementing the `__get__` method.

```
from functools import wraps
from types import MethodType

class inject_db_driver:
    """Convert a string to a DBDriver instance and pass this to the
    wrapped function."""

    def __init__(self, function):
        self.function = function
```

```
        wraps(self.function)(self)

    def __call__(self, dbstring):
        return self.function(DBDriver(dbstring))

    def __get__(self, instance, owner):
        if instance is None:
            return self
        return self.__class__(MethodType(self.function, instance))
```

Details on descriptors will be explained in Chapter 6, *Getting More Out of Our Objects with Descriptors*, but for the purposes of this example, we can now say that what it does is actually rebinding the callable it's decorating to a method, meaning that it will bind the function to the object, and then recreate the decorator with this new callable.

For functions, it still works, because it won't call the `__get__` method at all.

The DRY principle with decorators

We have seen how decorators allow us to abstract away certain logic into a separate component. The main advantage of this is that we can then apply the decorator multiple times into different objects in order to reuse code. This follows the **Don't Repeat Yourself (DRY)** principle since we define certain knowledge once and only once.

The `retry` mechanism implemented in the previous sections is a good example of a decorator that can be applied multiple times to reuse code. Instead of making each particular function include its `retry` logic, we create a decorator and apply it several times. This makes sense once we have made sure that the decorator can work with methods and functions equally.

The class decorator that defined how events are to be represented also complies with the DRY principle in the sense that it defines one specific place for the logic for serializing an event, without needing to duplicate code scattered among different classes. Since we expect to reuse this decorator and apply it to many classes, its development (and complexity) pay off.

This last remark is important to bear in mind when trying to use decorators in order to reuse code—we have to be absolutely sure that we will actually be saving code.

Any decorator (especially if it is not carefully designed) adds another level of indirection to the code, and hence more complexity. Readers of the code might want to follow the path of the decorator to fully understand the logic of the function (although these considerations are addressed in the following section), so keep in mind that this complexity has to pay off. If there is not going to be too much reuse, then do not go for a decorator and opt for a simpler option (maybe just a separate function or another small class is enough).

But how do we know what too much reuse is? Is there a rule to determine when to refactor existing code into a decorator? There is nothing specific to decorators in Python, but we could apply a general rule of thumb in software engineering (GLASS 01) that states that a component should be tried out at least three times before considering creating a generic abstraction in the sort of a reusable component. From the same reference (GLASS 01); (we encourage all readers to read *Facts and Fallacies of Software Engineering* because it is a great reference) also comes the idea that creating reusable components is three times harder than creating simple ones.

The bottom line is that reusing code through decorators is acceptable, but only when you take into account the following considerations:

- Do not create the decorator in the first place from scratch. Wait until the pattern emerges and the abstraction for the decorator becomes clear, and then refactor.
- Consider that the decorator has to be applied several times (at least three times) before implementing it.
- Keep the code in the decorators to a minimum.

Decorators and separation of concerns

The last point on the previous list is so important that it deserves a section of its own. We have already explored the idea of reusing code and noticed that a key element of reusing code is having components that are cohesive. This means that they should have the minimum level of responsibility—do one thing, one thing only, and do it well. The smaller our components, the more reusable, and the more they can be applied in a different context without carrying extra behavior that will cause coupling and dependencies, which will make the software rigid.

To show you what this means, let's reprise one of the decorators that we used in a previous example. We created a decorator that traced the execution of certain functions with code similar to the following:

```
def traced_function(function):
    @functools.wraps(function)
```

```
def wrapped(*args, **kwargs):
    logger.info("started execution of %s", function.__qualname__)
    start_time = time.time()
    result = function(*args, **kwargs)
    logger.info(
        "function %s took %.2fs",
        function.__qualname__,
        time.time() - start_time
    )
    return result
return wrapped
```

Now, this decorator, while it works, has a problem—it is doing more than one thing. It logs that a particular function was just invoked, and also logs how much time it took to run. Every time we use this decorator, we are carrying these two responsibilities, even if we only wanted one of them.

This should be broken down into smaller decorators, each one with a more specific and limited responsibility:

```
def log_execution(function):
    @wraps(function)
    def wrapped(*args, **kwargs):
        logger.info("started execution of %s", function.__qualname__)
        return function(*args, **kwargs)
    return wrapped

def measure_time(function):
    @wraps(function)
    def wrapped(*args, **kwargs):
        start_time = time.time()
        result = function(*args, **kwargs)

        logger.info("function %s took %.2f", function.__qualname__,
            time.time() - start_time)
        return result
    return wrapped
```

Notice that the same functionality that we had previously can be achieved by simply combining both of them:

```
@measure_time
@log_execution
def operation():
    ....
```

Notice how the order in which the decorators are applied is also important.



Do not place more than one responsibility in a decorator. The SRP applies to decorators as well.

Analyzing good decorators

As a closing note for this chapter, let's review some examples of good decorators and how they are used both in Python itself, as well as in popular libraries. The idea is to get guidelines on how good decorators are created.

Before jumping into examples, let's first identify traits that good decorators should have:

- **Encapsulation, or separation of concerns:** A good decorator should effectively separate different responsibilities between what it does and what it is decorating. It cannot be a leaky abstraction, meaning that a client of the decorator should only invoke it in black box mode, without knowing how it is actually implementing its logic.
- **Orthogonality:** What the decorator does should be independent, and as decoupled as possible from the object it is decorating.
- **Reusability:** It is desirable that the decorator can be applied to multiple types, and not that it just appears on one instance of one function, because that means that it could just have been a function instead. It has to be generic enough.

A nice example of decorators can be found in the Celery project, where a `task` is defined by applying the decorator of the `task` from the application to a function:

```
@app.task
def mytask():
    ....
```

One of the reasons why this is a good decorator is because it is very good at something—encapsulation. The user of the library only needs to define the function body and the decorator will convert that into a task automatically. The "`@app.task`" decorator surely wraps a lot of logic and code, but none of that is relevant to the body of "`mytask()`". It is complete encapsulation and separation of concerns—nobody will have to take a look at what that decorator does, so it is a correct abstraction that does not leak any details.

Another common use of decorators is in web frameworks (Pyramid, Flask, and Sanic, just to name a few), on which the handlers for views are registered to the URLs through decorators:

```
@route("/", method=["GET"])
def view_handler(request):
    ...
```

These sorts of decorator have the same considerations as before; they also provide total encapsulation because a user of the web framework rarely (if ever) needs to know what the `@route` decorator is doing. In this case, we know that the decorator is doing something more, such as registering these functions to a mapper to the URL, and also that it is changing the signature of the original function to provide us with a nicer interface that receives a request object with all the information already set.

The previous two examples are enough to make us notice something else about this use of decorators. They conform to an API. These libraries of frameworks are exposing their functionality to users through decorators, and it turns out that decorators are an excellent way of defining a clean programming interface.

This is probably the best way we should think about to decorators. Much like in the example of the class decorator that tells us how the attributes of the event are going to be handled, a good decorator should provide a clean interface so that users of the code know what to expect from the decorator, without needing to know how it works, or any of its details for that matter.

Summary

Decorators are powerful tools in Python that can be applied to many things such as classes, methods, functions, generators, and many more. We have demonstrated how to create decorators in different ways, and for different purposes, and drew some conclusions along the way.

When creating a decorator for functions, try to make its signature match the original function being decorated. Instead of using the generic `*args`, and `**kwargs`, making the signature match the original one will make it easier to read, and maintain, and it will resemble the original function more closely, so it will be more familiar to readers of that code.

Decorators are a very useful tool for reusing code and following the DRY principle. However, their usefulness comes at a cost, and if they are not used wisely, the complexity can do more harm than good. For that reason, we emphasize that decorators should be used when they are actually going to be applied multiple times (three or more times). In the same way as the DRY principle, we find the ideas of separation of concerns, with the goal of keeping the decorators as small as possible.

Another good use of decorators is to create cleaner interfaces, for instance, simplifying the definition of a class by extracting part of its logic into a decorator. In this sense, decorators also help readability by providing the users with information about what that particular component will be doing, without needing to know how (encapsulation).

In the next chapter, we will take a look at another advanced feature of Python—descriptors. In particular, we will see how with the help of descriptors we can create even better decorators, and solve some of the issues we encountered in this chapter.

References

Here is a list of information you can refer to:

- *PEP-318: Decorators for Functions and Methods* (<https://www.python.org/dev/peps/pep-0318/>)
- *PEP-3129: Class Decorators* (<https://www.python.org/dev/peps/pep-3129/>)
- *WRAPT 01*: <https://pypi.org/project/wrapt/>
- *WRAPT 02*: <https://wrapt.readthedocs.io/en/latest/decorators.html#universal-decorators>
- *The Functools module: The wraps function in the functools module of Python's standard library* (<https://docs.python.org/3/library/functools.html#functools.wrap>)
- *ATTRS 01: The attrs library* (<https://pypi.org/project/attrs/>)
- *PEP-557: Data Classes* (<https://www.python.org/dev/peps/pep-0557/>)
- *GLASS 01: The book written by Robert L. Glass named Facts and Fallacies of Software Engineering*

6

Getting More Out of Our Objects with Descriptors

This chapter introduces a new concept that is more advanced in Python development since it features descriptors. Moreover, descriptors are not something programmers of other languages are familiar with, so there are no easy analogies or parallelisms to make.

Descriptors are another distinctive feature of Python that takes object-oriented programming to another level, and their potential allows users to build more powerful and reusable abstractions. Most of the time, the full potential of descriptors is observed in libraries or frameworks.

In this chapter, we will achieve the following goals that relate to descriptors:

- Understand what descriptors are, how they work, and how to implement them effectively
- Analyze the two types of descriptors (data and non-data descriptors), in term of their conceptual differences and implementation details
- Reuse code effectively through descriptors
- Analyze examples of good uses of descriptors, and how to take advantage of them for our own libraries or APIs

A first look at descriptors

First, we will explore the main idea behind descriptors to understand their mechanics and internal workings. Once this is clear, it will be easier to assimilate how the different types of descriptors work, which we will explore in the next section.

Once we have a first understanding of the idea behind descriptors, we will look at an example where their use gives us a cleaner and more Pythonic implementation.

The machinery behind descriptors

The way descriptors work is not all that complicated, but the problem with them is that there are a lot of caveats to take into consideration, so the implementation details are of the utmost importance here.

In order to implement descriptors, we need at least two classes. For the purposes of this generic example, we are going to call the `client` class to the one that is going to take advantage of the functionality we want to implement in the `descriptor` (this class is generally just a domain model one, a regular abstraction we create for our solution), and we are going to call the `descriptor` class to the one that implements the logic of the descriptor.

A descriptor is, therefore, just an object that is an instance of a class that implements the descriptor protocol. This means that this class must have its interface containing at least one of the following magic methods (part of the descriptor protocol as of Python 3.6+):

- `__get__`
- `__set__`
- `__delete__`
- `__set_name__`

For the purposes of this initial high-level introduction, the following naming convention will be used:

Name	Meaning
ClientClass	The domain-level abstraction that will take advantage of the functionality to be implemented by the descriptor. This class is said to be a client of the descriptor. This class contains a class attribute (named <code>descriptor</code> by this convention), which is an instance of <code>DescriptorClass</code> .
DescriptorClass	The class that implements the <code>descriptor</code> itself. This class should implement some of the aforementioned magic methods that entail the descriptor protocol.
client	An instance of <code>ClientClass</code> . <code>client = ClientClass()</code>
descriptor	An instance of <code>DescriptorClass</code> . <code>descriptor = DescriptorClass()</code> . This object is a class attribute that is placed in <code>ClientClass</code> .

This relationship is illustrated in the following diagram:

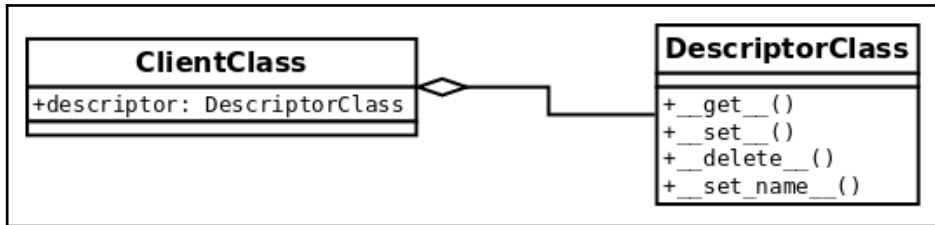

A very important observation to keep in mind is that for this protocol to work, the `descriptor` object has to be defined as a class attribute. Creating this object as an instance attribute will not work, so it must be in the body of the class, and not in the `init` method.



Always place the `descriptor` object as a class attribute!

On a slightly critical note, readers can also note that it is possible to implement the descriptor protocol partially—not all methods must always be defined; instead, we can implement only those we need, as we will see shortly.

So, now we have the structure in place—we know what elements are set and how they interact. We need a class for the `descriptor`, another class that will consume the logic of the `descriptor`, which, in turn, will have a `descriptor` object (an instance of the `DescriptorClass`) as a class attribute, and instances of `ClientClass` that will follow the descriptor protocol when we call for the attribute named `descriptor`. But now what? How does all of this fit into place at runtime?

Normally, when we have a regular class and we access its attributes, we simply obtain the objects as we expect them, and even their properties, as in the following example:

```

>>> class Attribute:
...     value = 42
...
>>> class Client:
...     attribute = Attribute()
...
>>> Client().attribute
<__main__.Attribute object at 0x7ff37ea90940>
>>> Client().attribute.value
42
  
```

But, in the case of descriptors, something different happens. When an object is defined as a class attribute (and this one is a `descriptor`), when a `client` requests this attribute, instead of getting the object itself (as we would expect from the previous example), we get the result of having called the `__get__` magic method.

Let's start with some simple code that only logs information about the context, and returns the same `client` object:

```
class DescriptorClass:
    def __get__(self, instance, owner):
        if instance is None:
            return self
        logger.info("Call: %s.__get__(%r, %r)",
                    self.__class__.__name__, instance, owner)
        return instance

class ClientClass:
    descriptor = DescriptorClass()
```

When running this code, and requesting the `descriptor` attribute of an instance of `ClientClass`, we will discover that we are, in fact, not getting an instance of `DescriptorClass`, but whatever its `__get__()` method returns instead:

```
>>> client = ClientClass()
>>> client.descriptor
INFO:Call: DescriptorClass.__get__(<ClientClass object at 0x...>, <class
'ClientClass'>)
<ClientClass object at 0x...>
>>> client.descriptor is client
INFO:Call: DescriptorClass.__get__(ClientClass object at 0x...>, <class
'ClientClass'>)
True
```

Notice how the logging line, placed under the `__get__` method, was called instead of just returning the object we created. In this case, we made that method return the `client` itself, hence making true a comparison of the last statement. The parameters of this method are explained in more detail in the following subsections when we explore each method in more detail.

Starting from this simple, yet demonstrative example, we can start creating more complex abstractions and better decorators, because the important note here is that we have a new (powerful) tool to work with. Notice how this changes the control flow of the program in a completely different way. With this tool, we can abstract all sorts of logic behind the `__get__` method, and make the `descriptor` transparently run all sorts of transformations without clients even noticing. This takes encapsulation to a new level.

Exploring each method of the descriptor protocol

Up until now, we have seen quite a few examples of descriptors in action, and we got the idea of how they work. These examples gave us a first glimpse of the power of descriptors, but you might be wondering about some implementation details and idioms whose explanation we failed to address.

Since descriptors are just objects, these methods take `self` as the first parameter. For all of them, this just means the `descriptor` object itself.

In this section, we will explore each method of the descriptor protocol, in full detail, explaining what each parameter signifies, and how they are intended to be used.

`__get__(self, instance, owner)`

The first parameter, `instance`, refers to the object from which the `descriptor` is being called. In our first example, this would mean the `client` object.

The `owner` parameter is a reference to the class of that object, which following our example (from the previous class diagram in *The machinery behind descriptors* section) would be `ClientClass`.

From the previous paragraph we conclude that the parameter named `instance` in the signature of `__get__` is the object over which the descriptor is taking action, and `owner` is the class of `instance`. The avid reader might be wondering why is the signature define like this, after all the class can be taken from `instance` directly (`owner = instance.__class__`). There is an edge case—when the `descriptor` is called from the class (`ClientClass`), not from the instance (`client`), then the value of `instance` is `None`, but we might still want to do some processing in that case.

With the following simple code we can demonstrate the difference of when a descriptor is being called from the class, or from an instance. In this case, the `__get__` method is doing two separate things for each case.

```
# descriptors_methods_1.py

class DescriptorClass:
    def __get__(self, instance, owner):
        if instance is None:
            return f"{self.__class__.__name__}.{owner.__name__}"
        return f"value for {instance}"

class ClientClass:

    descriptor = DescriptorClass()
```

When we call it from `ClientClass` directly it will do one thing, which is composing a namespace with the names of the classes:

```
>>> ClientClass.descriptor
'DescriptorClass.ClientClass'
```

And then if we call it from an object we have created, it will return the other message instead:

```
>>> ClientClass().descriptor
'value for <descriptors_methods_1.ClientClass object at 0x...>'
```

In general, unless we really need to do something with the `owner` parameter, the most common idiom, is to just return the descriptor itself, when `instance` is `None`.

`__set__(self, instance, value)`

This method is called when we try to assign something to a descriptor. It is activated with statements such as the following, in which a `descriptor` is an object that implements `__set__()`. The `instance` parameter, in this case, would be `client`, and the `value` would be the "value" string:

```
client.descriptor = "value"
```

If `client.descriptor` doesn't implement `__set__()`, then "value" will override the descriptor entirely.



Be careful when assigning a value to an attribute that is a descriptor. Make sure it implements the `__set__` method, and that we are not causing an undesired side effect.

By default, the most common use of this method is just to store data in an object. Nevertheless, we have seen how powerful descriptors are so far, and that we can take advantage of them, for example, if we were to create generic validation objects that can be applied multiple times (again, this is something that if we don't abstract, we might end up repeating multiple times in setter methods of properties).

The following listing illustrates how we can take advantage of this method in order to create generic `validation` objects for attributes, which can be created dynamically with functions to validate on the values before assigning them to the object:

```
class Validation:
    def __init__(self, validation_function, error_msg: str):
        self.validation_function = validation_function
        self.error_msg = error_msg

    def __call__(self, value):
        if not self.validation_function(value):
            raise ValueError(f"{value!r} {self.error_msg}")

class Field:
    def __init__(self, *validations):
        self._name = None
        self.validations = validations

    def __set_name__(self, owner, name):
        self._name = name

    def __get__(self, instance, owner):
        if instance is None:
            return self
        return instance.__dict__[self._name]

    def validate(self, value):
        for validation in self.validations:
            validation(value)

    def __set__(self, instance, value):
        self.validate(value)
```

```

instance.__dict__[self._name] = value

class ClientClass:
    descriptor = Field(
        Validation(lambda x: isinstance(x, (int, float)), "is not a
        number"),
        Validation(lambda x: x >= 0, "is not >= 0"),
    )

```

We can see this object in action in the following listing:

```

>>> client = ClientClass()
>>> client.descriptor = 42
>>> client.descriptor
42
>>> client.descriptor = -42
Traceback (most recent call last):
...
ValueError: -42 is not >= 0
>>> client.descriptor = "invalid value"
...
ValueError: 'invalid value' is not a number

```

The idea is that something that we would normally place in a property can be abstracted away into a descriptor, and reuse it multiple times. In this case, the `__set__()` method would be doing what the `@property.setter` would have been doing.

`__delete__(self, instance)`

This method is called upon with the following statement, in which `self` would be the descriptor attribute, and `instance` would be the `client` object in this example:

```
>>> del client.descriptor
```

In the following example, we use this method to create a descriptor with the goal of preventing you from removing attributes from an object without the required administrative privileges. Notice how, in this case, that the descriptor has logic that is used to predicate with the values of the object that is using it, instead of different related objects:

```

# descriptors_methods_3.py

class ProtectedAttribute:
    def __init__(self, requires_role=None) -> None:
        self.permission_required = requires_role

```

```
        self._name = None

    def __set_name__(self, owner, name):
        self._name = name

    def __set__(self, user, value):
        if value is None:
            raise ValueError(f"{self._name} can't be set to None")
        user.__dict__[self._name] = value

    def __delete__(self, user):
        if self.permission_required in user.permissions:
            user.__dict__[self._name] = None
        else:
            raise ValueError(
                f"User {user!s} doesn't have {self.permission_required} "
                "permission"
            )

class User:
    """Only users with "admin" privileges can remove their email
    address."""

    email = ProtectedAttribute(requires_role="admin")

    def __init__(self, username: str, email: str, permission_list: list =
None) -> None:
        self.username = username
        self.email = email
        self.permissions = permission_list or []

    def __str__(self):
        return self.username
```

Before seeing examples of how this object works, it's important to remark some of the criteria of this descriptor. Notice the `User` class requires the `username` and `email` as mandatory parameters. According to its `__init__` method, it cannot be a user if it doesn't have an `email` attribute. If we were to delete that attribute, and extract it from the object entirely we would be creating an inconsistent object, with some invalid intermediate state that does not correspond to the interface defined by the class `User`. Details like this one are really important, in order to avoid issues. Some other object is expecting to work with this `User`, and it also expects that it has an `email` attribute.

For this reason, it was decided that the "deletion" of an email will just simply set it to `None`, and that is the part of the code listing that is in bold. For the same reason, we must forbid someone trying to set a `None` value to it, because that would bypass the mechanism we placed in the `__delete__` method.

Here, we can see it in action, assuming a case where only users with "admin" privileges can remove their email address:

```
>>> admin = User("root", "root@d.com", ["admin"])
>>> user = User("user", "user1@d.com", ["email", "helpdesk"])
>>> admin.email
'root@d.com'
>>> del admin.email
>>> admin.email is None
True
>>> user.email
'user1@d.com'
>>> user.email = None
...
ValueError: email can't be set to None
>>> del user.email
...
ValueError: User user doesn't have admin permission
```

Here, in this simple `descriptor`, we see that we can delete the email from users that contain the "admin" permission only. As for the rest, when we try to call `del` on that attribute, we will get a `ValueError` exception.

In general, this method of the descriptor is not as commonly used as the two previous ones, but it is worth showing it for completeness.

`__set_name__(self, owner, name)`

When we create the `descriptor` object in the class that is going to use it, we generally need the `descriptor` to know the name of the attribute it is going to be handling.

This attribute name is the one we use to read from and write to `__dict__` in the `__get__` and `__set__` methods, respectively.

Before Python 3.6, the descriptor couldn't take this name automatically, so the most general approach was to just pass it explicitly when initializing the object. This works fine, but it has an issue in that it requires that we duplicate the name every time we want to use the descriptor for a new attribute.

This is what a typical descriptor would look like if we didn't have this method:

```
class DescriptorWithName:
    def __init__(self, name):
        self.name = name

    def __get__(self, instance, value):
        if instance is None:
            return self
        logger.info("getting %r attribute from %r", self.name, instance)
        return instance.__dict__[self.name]

    def __set__(self, instance, value):
        instance.__dict__[self.name] = value

class ClientClass:
    descriptor = DescriptorWithName("descriptor")
```

We can see how the descriptor uses this value:

```
>>> client = ClientClass()
>>> client.descriptor = "value"
>>> client.descriptor
INFO:getting 'descriptor' attribute from <ClientClass object at 0x...>
'value'
```

Now, if we wanted to avoid writing the name of the attribute twice (once for the variable assigned inside the class, and once again as the name of the first parameter of the descriptor), we have to resort to a few tricks, like using a class decorator, or (even worse) using a metaclass.

In Python 3.6, the new method `__set_name__` was added, and it receives the class where that descriptor is being created, and the name that is being given to that descriptor. The most common idiom is to use this method for the descriptor so that it can store the required name in this method.

For compatibility, it is generally a good idea to keep a default value in the `__init__` method but still take advantage of `__set_name__`.

With this method, we can rewrite the previous descriptors as follows:

```
class DescriptorWithName:
    def __init__(self, name=None):
        self.name = name

    def __set_name__(self, owner, name):
        self.name = name
    ...
```

Types of descriptors

Based on the methods we have just explored, we can make an important distinction among descriptors in terms of how they work. Understanding this distinction plays an important role in working effectively with descriptors, and will also help to avoid caveats or common errors at runtime.

If a descriptor implements the `__set__` or `__delete__` methods, it is called a **data descriptor**. Otherwise, a descriptor that solely implements `__get__` is a **non-data descriptor**. Notice that `__set_name__` does not affect this classification at all.

When trying to resolve an attribute of an object, a data descriptor will always take precedence over the dictionary of the object, whereas a non-data descriptor will not. This means that in a non-data descriptor if the object has a key on its dictionary with the same name as the descriptor, this one will always be called, and the descriptor itself will never run. Conversely, in a data descriptor, even if there is a key in the dictionary with the same name as the descriptor, this one will never be used since the descriptor itself will always end up being called.

The following two sections explain this in more detail, with examples, in order to get a deeper idea of what to expect from each type of descriptor.

Non-data descriptors

We will start with a descriptor that only implements the `__get__` method, and see how it is used:

```
class NonDataDescriptor:
    def __get__(self, instance, owner):
        if instance is None:
            return self
        return 42
```

```
class ClientClass:
    descriptor = NonDataDescriptor()
```

As usual, if we ask for the `descriptor`, we get the result of its `__get__` method:

```
>>> client = ClientClass()
>>> client.descriptor
42
```

But if we change the `descriptor` attribute to something else, we lose access to this value, and get what was assigned to it instead:

```
>>> client.descriptor = 43
>>> client.descriptor
43
```

Now, if we delete the `descriptor`, and ask for it again, let's see what we get:

```
>>> del client.descriptor
>>> client.descriptor
42
```

Let's rewind what just happened. When we first created the `client` object, the `descriptor` attribute lay in the class, not the instance, so if we ask for the dictionary of the `client` object, it will be empty:

```
>>> vars(client)
{}
```

And then, when we request the `.descriptor` attribute, it doesn't find any key in `client.__dict__` named "descriptor", so it goes to the class, where it will find it ... but only as a descriptor, hence why it returns the result of the `__get__` method.

But then, we change the value of the `.descriptor` attribute to something else, and what this does is set this into the dictionary of the instance, meaning that this time it won't be empty:

```
>>> client.descriptor = 99
>>> vars(client)
{'descriptor': 99}
```

So, when we ask for the `.descriptor` attribute here, it will look for it in the object (and this time it will find it, because there is a key named `descriptor` in the `__dict__` attribute of the object, as the `vars` result is showing us), and return it without having to look for it in the class. For this reason, the descriptor protocol is never invoked, and the next time we ask for this attribute, it will instead return the value we have overridden it with (99).

Afterward, we delete this attribute by calling `del`, and what this does is remove the key `"descriptor"` from the dictionary of the object, leaving us back in the first scenario, where it's going to default to the class where the descriptor protocol will be activated:

```
>>> del client.descriptor
>>> vars(client)
{}
>>> client.descriptor
42
```

This means that if we set the attribute of the `descriptor` to something else, we might be accidentally breaking it. Why? Because the `descriptor` doesn't handle the delete action (some of them don't need to).

This is called a non-data descriptor because it doesn't implement the `__set__` magic method, as we will see in the next example.

Data descriptors

Now, let's look at the difference of using a data descriptor. For this, we are going to create another simple `descriptor` that implements the `__set__` method:

```
class DataDescriptor:

    def __get__(self, instance, owner):
        if instance is None:
            return self
        return 42

    def __set__(self, instance, value):
        logger.debug("setting %s.descriptor to %s", instance, value)
        instance.__dict__["descriptor"] = value

class ClientClass:
    descriptor = DataDescriptor()
```

Let's see what the value of the `descriptor` returns:

```
>>> client = ClientClass()
>>> client.descriptor
42
```

Now, let's try to change this value to something else, and see what it returns instead:

```
>>> client.descriptor = 99
>>> client.descriptor
42
```

The value returned by the `descriptor` didn't change. But when we assign a different value to it, it must be set to the dictionary of the object (as it was previously):

```
>>> vars(client)
{'descriptor': 99}

>>> client.__dict__["descriptor"]
99
```

So, the `__set__()` method was called, and indeed it did set the value to the dictionary of the object, only this time, when we request this attribute, instead of using the `__dict__` attribute of the dictionary, the `descriptor` takes precedence (because it's an overriding descriptor).

One more thing—deleting the attribute will not work anymore:

```
>>> del client.descriptor
Traceback (most recent call last):
...
AttributeError: __delete__
```

The reason is as follows—given that now, the `descriptor` always takes place, calling `del` on an object doesn't try to delete the attribute from the dictionary (`__dict__`) of the object, but instead it tries to call the `__delete__()` method of the descriptor (which is not implemented in this example, hence the attribute error).

This is the difference between data and non-data descriptors. If the descriptor implements `__set__()`, then it will always take precedence, no matter what attributes are present in the dictionary of the object. If this method is not implemented, then the dictionary will be looked up first, and then the descriptor will run.

An interesting observation you might have noticed is this line on the `set` method:

```
instance.__dict__["descriptor"] = value
```

There are a lot of things to question about that line, but let's break it down into parts.

First, why is it altering just the name of a "descriptor" attribute? This is just a simplification for this example, but, as it transpires when working with descriptors, it doesn't know at this point the name of the parameter it was assigned to, so we just used the one from the example, knowing that it was going to be "descriptor".

In a real example, you would do one of two things—either receive the name as a parameter and store it internally in the `init` method, so that this one will just use the internal attribute, or, even better, use the `__set_name__` method.

Why is it accessing the `__dict__` attribute of the instance directly? Another good question, which also has at least two explanations. First, you might be thinking why not just do the following:

```
setattr(instance, "descriptor", value)
```

Remember that this method (`__set__`) is called when we try to assign something to the attribute that is a descriptor. So, using `setattr()` will call this descriptor again, which, in turn, will call it again, and so on and so forth. This will end up in an infinite recursion.



Do not use `setattr()` or the assignment expression directly on the descriptor inside the `__set__` method because that will trigger an infinite recursion.

Why, then, is the descriptor not able to book-keep the values of the properties for all of its objects?

The `client` class already has a reference to the descriptor. If we add a reference from the descriptor to the `client` object, we are creating circular dependencies, and these objects will never be garbage-collected. Since they are pointing at each other, their reference counts will never drop below the threshold for removal.

A possible alternative here is to use weak references, with the `weakref` module, and create a weak reference key dictionary if we want to do that. This implementation is explained later on in this chapter, but for the implementations within this book, we prefer to use this idiom, since it is fairly common and accepted when writing descriptors.

Descriptors in action

Now that we have seen what descriptors are, how they work, and what the main ideas behind them are, we can see them in action. In this section, we will be exploring some situations that can be elegantly addressed through descriptors.

Here, we will look at some examples of working with descriptors, and we will also cover implementation considerations for them (different ways of creating them, with their pros and cons), and finally we will discuss what the most suitable scenarios for descriptors are.

An application of descriptors

We will start with a simple example that works, but that will lead to some code duplication. It is not very clear how this issue will be addressed. Later on, we will devise a way of abstracting the repeated logic into a descriptor, which will address the duplication problem, and we will notice that the code on our client classes will be reduced drastically.

A first attempt without using descriptors

The problem we want to solve now is that we have a regular class with some attributes, but we wish to track all of the different values a particular attribute has over time, for example, in a list. The first solution that comes to our mind is to use a property, and every time a value is changed for that attribute in the setter method of the property, we add it to an internal list that will keep this trace as we want it.

Imagine that our class represents a traveler in our application that has a current city, and we want to keep track of all the cities that user has visited throughout the running of the program. The following code is a possible implementation that addresses these requirements:

```
class Traveller:

    def __init__(self, name, current_city):
        self.name = name
        self._current_city = current_city
        self._cities_visited = [current_city]

    @property
    def current_city(self):
        return self._current_city

    @current_city.setter
```

```
def current_city(self, new_city):
    if new_city != self._current_city:
        self._cities_visited.append(new_city)
    self._current_city = new_city

@property
def cities_visited(self):
    return self._cities_visited
```

We can easily check that this code works according to our requirements:

```
>>> alice = Traveller("Alice", "Barcelona")
>>> alice.current_city = "Paris"
>>> alice.current_city = "Brussels"
>>> alice.current_city = "Amsterdam"

>>> alice.cities_visited
['Barcelona', 'Paris', 'Brussels', 'Amsterdam']
```

So far, this is all we need and nothing else has to be implemented. For the purposes of this problem, the property would be more than enough. What happens if we need the exact same logic in multiple places of the application? This would mean that this is actually an instance of a more generic problem—tracing all the values of an attribute in another one. What would happen if we want to do the same with other attributes, such as keeping track of all tickets Alice bought, or all the countries she has been in? We would have to repeat the logic in all of these places.

Moreover, what would happen if we need this same behavior in different classes? We would have to repeat the code or come up with a generic solution (maybe a decorator, a property builder, or a descriptor). Since property builders are a particular (and more convoluted) case of descriptors, they are beyond of the scope of this book, and instead, descriptors are suggested as a cleaner way of proceeding.

The idiomatic implementation

We will now look at how to address the questions of the previous section by using a descriptor that is generic enough as to be applied in any class. Again, this example is not really needed because the requirements do not specify such generic behavior (we haven't even followed the rule of three instances of the similar pattern previously creating the abstraction), but it is shown with the goal of portraying descriptors in action.



Do not implement a descriptor unless there is actual evidence of the repetition we are trying to solve, and the complexity is proven to have paid off.

Now, we will create a generic descriptor that, given a name for the attribute to hold the traces of another one, will store the different values of the attribute in a list.

As we mentioned previously, the code is more than what we need for the problem, but its intention is just to show how a descriptor would help us in this case. Given the generic nature of descriptors, the reader will notice that the logic on it (the name of their method, and attributes) does not relate to the domain problem at hand (a traveler object). This is because the idea of the descriptor is to be able to use it in any type of class, probably on different projects, with the same outcomes.

In order to address this gap, some parts of the code are annotated, and the respective explanation for each section (what it does, and how it relates to the original problem) is described in the following code:

```
class HistoryTracedAttribute:
    def __init__(self, trace_attribute_name) -> None:
        self.trace_attribute_name = trace_attribute_name # [1]
        self._name = None

    def __set_name__(self, owner, name):
        self._name = name

    def __get__(self, instance, owner):
        if instance is None:
            return self
        return instance.__dict__[self._name]

    def __set__(self, instance, value):
        self._track_change_in_value_for_instance(instance, value)
        instance.__dict__[self._name] = value

    def _track_change_in_value_for_instance(self, instance, value):
        self._set_default(instance) # [2]
        if self._needs_to_track_change(instance, value):
            instance.__dict__[self.trace_attribute_name].append(value)

    def _needs_to_track_change(self, instance, value) -> bool:
        try:
            current_value = instance.__dict__[self._name]
        except KeyError: # [3]
            return True
```



```
        return value != current_value # [4]

    def _set_default(self, instance):
        instance.__dict__.setdefault(self.trace_attribute_name, []) # [6]

class Traveller:

    current_city = HistoryTracedAttribute("cities_visited") # [1]

    def __init__(self, name, current_city):
        self.name = name
        self.current_city = current_city # [5]
```

Some annotations and comments on the code are as follows (numbers in the list correspond to the number annotations in the previous listing):

1. The name of the attribute is one of the variables assigned to the `descriptor`, in this case, `current_city`. We pass to the `descriptor` the name of the variable in which it will store the trace for the variable of the `descriptor`. In this example, we are telling our object to keep track of all the values that `current_city` has had in the attribute named `cities_visited`.
2. The first time we call the `descriptor`, in the `init`, the attribute for tracing values will not exist, in which case we initialize it to an empty list to later append values to it.
3. In the `init` method, the name of the attribute `current_city` will not exist either, so we want to keep track of this change as well. This is the equivalent of initializing the list with the first value in the previous example.
4. Only track changes when the new value is different from the one that is currently set.
5. In the `init` method, the `descriptor` already exists, and this assignment instruction triggers the actions from step 2 (create the empty list to start tracking values for it), and step 3 (append the value to this list, and set it to the key in the object for retrieval later).
6. The `setdefault` method in a dictionary is used to avoid a `KeyError`. In this case an empty list will be returned for those attributes that aren't still available (see <https://docs.python.org/3.6/library/stdtypes.html#dict.setdefault> for reference).

It is true that the code in the `descriptor` is rather complex. On the other hand, the code in the `client` class is considerably simpler. Of course, this balance only pays off if we are going to use this `descriptor` multiple times, which is a concern we have already covered.

What might not be so clear at this point is that the descriptor is indeed completely independent from the `client` class. Nothing in it suggests anything about the business logic. This makes it perfectly suitable to apply it in any other class; even if it does something completely different, the descriptor will take the same effect.

This is the true Pythonic nature of descriptors. They are more appropriate for defining libraries, frameworks, or internal APIs, and not that much for business logic.

Different forms of implementing descriptors

We have to first understand a common issue that's specific to the nature of descriptors before thinking of ways of implementing them. First, we will discuss the problem of a global shared state, and afterward we will move on and look at different ways descriptors can be implemented while taking this into consideration.

The issue of global shared state

As we have already mentioned, descriptors need to be set as class attributes to work. This should not be a problem most of the time, but it does come with some warnings that need to be taken into consideration.

The problem with class attributes is that they are shared across all instances of that class. Descriptors are not an exception here, so if we try to keep data in a `descriptor` object, keep in mind that all of them will have access to the same value.

Let's see what happens when we incorrectly define a `descriptor` that keeps the data itself, instead of storing it in each object:

```
class SharedDataDescriptor:
    def __init__(self, initial_value):
        self.value = initial_value

    def __get__(self, instance, owner):
        if instance is None:
            return self
        return self.value

    def __set__(self, instance, value):
        self.value = value

class ClientClass:
    descriptor = SharedDataDescriptor("first value")
```

In this example, the `descriptor` object stores the data itself. This carries with it the inconvenience that when we modify the value for an `instance` all other instances of the same classes are also modified with this value as well. The following code listing puts that theory in action:

```
>>> client1 = ClientClass()
>>> client1.descriptor
'first value'

>>> client2 = ClientClass()
>>> client2.descriptor
'first value'

>>> client2.descriptor = "value for client 2"
>>> client2.descriptor
'value for client 2'

>>> client1.descriptor
'value for client 2'
```

Notice how we change one object, and suddenly all of them are from the same class, and we can see that this value is reflected. This is because `ClientClass.descriptor` is unique; it's the same object for all of them.

In some cases, this might be what we actually want (for instance, if we were to create a sort of Borg pattern implementation, on which we want to share state across all objects from a class), but in general, that is not the case, and we need to differentiate between objects. Such pattern is discussed with more detail in [Chapter 9, *Common Design Patterns*](#).

To achieve this, the descriptor needs to know the value for each `instance` and return it accordingly. That is the reason we have been operating with the dictionary (`__dict__`) of each `instance` and setting and retrieving the values from there.

This is the most common approach. We have already covered why we cannot use `getattr()` and `setattr()` on those methods, so modifying the `__dict__` attribute is the last standing option, and, in this case, is acceptable.

Accessing the dictionary of the object

The way we implement descriptors throughout this book is making the `descriptor` object store the values in the dictionary of the object, `__dict__`, and retrieve the parameters from there as well.



Always store and return the data from the `__dict__` attribute of the instance.

Using weak references

Another alternative (if we don't want to use `__dict__`) is to make the `descriptor` object keep track of the values for each instance itself, in an internal mapping, and return values from this mapping as well.

There is a caveat, though. This mapping cannot just be any dictionary. Since the `client` class has a reference to the descriptor, and now the descriptor will keep references to the objects that use it, this will create circular dependencies, and, as a result, these objects will never be garbage-collected because they are pointing at each other.

In order to address this, the dictionary has to be a weak key one, as defined in the `weakref (WEAKREF 01)` module.

In this case, the code for the `descriptor` might look like the following:

```
from weakref import WeakKeyDictionary

class DescriptorClass:
    def __init__(self, initial_value):
        self.value = initial_value
        self.mapping = WeakKeyDictionary()

    def __get__(self, instance, owner):
        if instance is None:
            return self
        return self.mapping.get(instance, self.value)

    def __set__(self, instance, value):
        self.mapping[instance] = value
```

This addresses the issues, but it does come with some considerations:

- The objects no longer hold their attributes—the descriptor does instead. This is somewhat controversial, and it might not be entirely accurate from a conceptual point of view. If we forget this detail, we might be asking the object by inspecting its dictionary, trying to find things that just aren't there (calling `vars(client)` will not return the complete data, for example).

- It poses the requirement over the objects that they need to be hashable. If they aren't, they can't be part of the mapping. This might be too demanding a requirement for some applications.

For these reasons, we prefer the implementation that has been shown so far in this book, which uses the dictionary of each instance. However, for completeness, we have shown this alternative as well.

More considerations about descriptors

Here, we will discuss general considerations about descriptors in terms of what we can do with them when it is a good idea to use them, and also how things that we might have initially conceived as having been resolved by means of another approach can be improved through descriptors. We will then analyze the pros and cons of the original implementation versus the one after descriptors have been used.

Reusing code

Descriptors are a generic tool and a powerful abstraction that we can use to avoid code duplication. The best way to decide when to use descriptors is to identify cases where we would be using a property (whether for its `get` logic, `set` logic, or both), but repeating its structure many times.

Properties are just a particular case of descriptors (the `@property` decorator is a descriptor that implements the full descriptor protocol to define their `get`, `set`, and `delete` actions), which means that we can use descriptors for far more complex tasks.

Another powerful type we have seen for reusing code was decorators, as explained in [Chapter 5, Using Decorators to Improve Our Code](#). Descriptors can help us create better decorators by making sure that they will be able to work correctly for class methods as well.

When it comes to decorators, we could say that it is safe to always implement the `__get__()` method on them, and also make it a descriptor. When trying to decide whether the decorator is worth creating, consider the three problems rule we stated in [Chapter 5, Using Decorators to Improve Our Code](#), but note that there are no extra considerations toward descriptors.

As for generic descriptors, besides the aforementioned three instances rule that applies to decorators (and, in general, any reusable component), it is advisable to also keep in mind that you should use descriptors for cases when we want to define an internal API, which is some code that will have clients consuming it. This is a feature-oriented more toward designing libraries and frameworks, rather than one-time solutions.

Unless there is a very good reason to, or that the code will look significantly better, we should avoid putting business logic in a descriptor. Instead, the code of a descriptor will contain more implementational code rather than business code. It is more similar to defining a new data structure or object that another part of our business logic will use as a tool.



In general, descriptors will contain implementation logic, and not so much business logic.

Avoiding class decorators

If we recall the class decorator we used in [Chapter 5, Using Decorators to Improve Our Code](#), to determine how an event object is going to be serialized, we ended up with an implementation that (for Python 3.7+) relied on two class decorators:

```
@Serialization(
    username=show_original,
    password=hide_field,
    ip=show_original,
    timestamp=format_time,
)
@dataclass
class LoginEvent:
    username: str
    password: str
    ip: str
    timestamp: datetime
```

The first one takes the attributes from the annotations to declare the variables, whereas the second one defines how to treat each file. Let's see whether we can change these two decorators for descriptors instead.

The idea is to create a descriptor that will apply the transformation over the values of each attribute, returning the modified version according to our requirements (for example, hiding sensitive information, and formatting dates correctly):

```
from functools import partial
from typing import Callable

class BaseFieldTransformation:

    def __init__(self, transformation: Callable[[], str]) -> None:
        self._name = None
        self.transformation = transformation

    def __get__(self, instance, owner):
        if instance is None:
            return self
        raw_value = instance.__dict__[self._name]
        return self.transformation(raw_value)

    def __set_name__(self, owner, name):
        self._name = name

    def __set__(self, instance, value):
        instance.__dict__[self._name] = value

ShowOriginal = partial(BaseFieldTransformation, transformation=lambda x: x)
HideField = partial(
    BaseFieldTransformation, transformation=lambda x: "***redacted**"
)
FormatTime = partial(
    BaseFieldTransformation,
    transformation=lambda ft: ft.strftime("%Y-%m-%d %H:%M"),
)
```

This descriptor is interesting. It was created with a function that takes one argument and returns one value. This function will be the transformation we want to apply to the field. From the base definition that defines generically how it is going to work, the rest of the descriptor classes are defined, simply by changing the particular function each one needs.

The example uses `functools.partial` (<https://docs.python.org/3.6/library/functools.html#functools.partial>) as a way of simulating sub-classes, by applying a partial application of the transformation function for that class, leaving a new callable that can be instantiated directly.

In order to keep the example simple, we will implement the `__init__()` and `serialize()` methods, although they could be abstracted away as well. Under these considerations, the class for the event will now be defined as follows:

```
class LoginEvent:
    username = ShowOriginal()
    password = HideField()
    ip = ShowOriginal()
    timestamp = FormatTime()

    def __init__(self, username, password, ip, timestamp):
        self.username = username
        self.password = password
        self.ip = ip
        self.timestamp = timestamp

    def serialize(self):
        return {
            "username": self.username,
            "password": self.password,
            "ip": self.ip,
            "timestamp": self.timestamp,
        }
```

We can see how the object behaves at runtime:

```
>>> le = LoginEvent("john", "secret password", "1.1.1.1",
datetime.utcnow())
>>> vars(le)
{'username': 'john', 'password': 'secret password', 'ip': '1.1.1.1',
'timestamp': ...}
>>> le.serialize()
{'username': 'john', 'password': '**redacted**', 'ip': '1.1.1.1',
'timestamp': '...'}
>>> le.password
'**redacted**'
```

There are some differences with respect to the previous implementation that used a decorator. This example added the `serialize()` method and hid the fields before presenting them to its resulting dictionary, but if we asked for any of these attributes to an instance of the event in memory at any point, it would still give us the original value, without any transformation applied to it (we could have chosen to apply the transformation when setting the value, and return it directly on the `__get__()`, as well).

Depending on the sensitivity of the application, this may or may not be acceptable, but in this case, when we ask the object for its `public` attributes, the descriptor will apply the transformation before presenting the results. It is still possible to access the original values by asking for the dictionary of the object (by accessing `__dict__`), but when we ask for the value, by default, it will return it converted.

In this example, all descriptors follow a common logic, which is defined in the base class. The descriptor should store the value in the object and then ask for it, applying the transformation it defines. We could create a hierarchy of classes, each one defining its own conversion function, in a way that the template method design pattern works. In this case, since the changes in the derived classes are relatively small (just one function), we opted for creating the derived classes as partial applications of the base class. Creating any new transformation field should be as simple as defining a new class that will be the base class, which is partially applied with the function we need. This can even be done ad hoc, so there might be no need to set a name for it.

Regardless of this implementation, the point is that since descriptors are objects, we can create models, and apply all rules of object-oriented programming to them. Design patterns also apply to descriptors. We could define our hierarchy, set the custom behavior, and so on. This example follows the OCP, which we introduced in Chapter 4, *The SOLID Principles*, because adding a new type of conversion method would just be about creating a new class, derived from the base one with the function it needs, without having to modify the base class itself (to be fair, the previous implementation with decorators was also OCP-compliant, but there were no classes involved for each transformation mechanism).

Let's take an example where we create a base class that implements the `__init__()` and `serialize()` methods so that we can define the `LoginEvent` class simply by deriving from it, as follows:

```
class LoginEvent(BaseEvent):
    username = ShowOriginal()
    password = HideField()
    ip = ShowOriginal()
    timestamp = FormatTime()
```

Once we achieve this code, the class looks cleaner. It only defines the attributes it needs, and its logic can be quickly analyzed by looking at the class for each attribute. The base class will abstract only the common methods, and the class of each event will look simpler and more compact.

Not only do the classes for each event look simple, but the descriptor itself is very compact and a lot simpler than the class decorators. The original implementation with class decorators was good, but descriptors made it even better.

Analysis of descriptors

We have seen how descriptors work so far and explored some interesting situations in which they contribute to clean design by simplifying their logic and leveraging more compact classes.

Up to this point, we know that by using descriptors, we can achieve cleaner code, abstracting away repeated logic and implementation details. But how do we know our implementation of the descriptors is clean and correct? What makes a good descriptor? Are we using this tool properly or over-engineering with it?

In this section, we will analyze descriptors in order to answer these questions.

How Python uses descriptors internally

Referring to the question as to what makes a good descriptor?, a simple answer would be that a good descriptor is pretty much like any other good Python object. It is consistent with Python itself. The idea that follows this premise is that analyzing how Python uses descriptors will give us a good idea of good implementations so that we know what to expect from the descriptors we write.

We will see the most common scenarios where Python itself uses descriptors to solve parts of its internal logic, and we will also discover elegant descriptors and that they have been there in plain sight all along.

Functions and methods

The most resonating case of an object that is a descriptor is probably a function. Functions implement the `__get__` method, so they can work as methods when defined inside a class.

Methods are just functions that take an extra argument. By convention, the first argument of a method is named "self", and it represents an instance of the class that the method is being defined in. Then, whatever the method does with "self", would be the same as any other function receiving the object and applying modifications to it.

In order words, when we define something like this:

```
class MyClass:
    def method(self, ...):
        self.x = 1
```

It is actually the same as if we define this:

```
class MyClass: pass

def method(myclass_instance, ...):
    myclass_instance.x = 1

method(MyClass())
```

So, it is just another function, modifying the object, only that it's defined inside the class, and it is said to be bound to the object.

When we call something in the form of this:

```
instance = MyClass()
instance.method(...)
```

Python is, in fact, doing something equivalent to this:

```
instance = MyClass()
MyClass.method(instance, ...)
```

Notice that this is just a syntax conversion that is handled internally by Python. The way this works is by means of descriptors.

Since functions implement the descriptor protocol (see the following listing) before calling the method, the `__get__()` method is invoked first, and some transformations happen before running the code on the internal callable:

```
>>> def function(): pass
...
>>> function.__get__
<method-wrapper '__get__' of function object at 0x...>
```

In the `instance.method(...)` statement, before processing all the arguments of the callable inside the parenthesis, the `"instance.method"` part is evaluated.

Since `method` is an object defined as a class attribute, and it has a `__get__` method, this is called. What this does is convert the `function` to a method, which means binding the callable to the instance of the object it is going to work with.

Let's see this with an example so that we can get an idea of what Python might be doing internally.

We will define a callable object inside a class that will act as a sort of function or method that we want to define to be invoked externally. An instance of the `Method` class is supposed to be a function or method to be used inside a different class. This function will just print its three parameters—the instance that it received (which would be the `self` parameter on the class it's being defined in), and two more arguments. Notice that in the `__call__()` method, the `self` parameter does not represent the instance of `MyClass`, but instead an instance of `Method`. The parameter named `instance` is meant to be a `MyClass` type of object:

```
class Method:
    def __init__(self, name):
        self.name = name

    def __call__(self, instance, arg1, arg2):
        print(f"{self.name}: {instance} called with {arg1} and {arg2}")

class MyClass:
    method = Method("Internal call")
```

Under these considerations and, after creating the object, the following two calls should be equivalent, based on the preceding definition:

```
instance = MyClass()
Method("External call")(instance, "first", "second")
instance.method("first", "second")
```

However, only the first one works as expected, as the second one gives an error:

```
Traceback (most recent call last):
  File "file", line , in <module>
    instance.method("first", "second")
TypeError: __call__() missing 1 required positional argument: 'arg2'
```

We are seeing the same error we faced with a decorator in Chapter 5, *Using Decorators to Improve Our Code*. The arguments are being shifted to the left by one, `instance` is taking the place of `self`, `arg1` is going to be `instance`, and there is nothing to provide for `arg2`.

In order to fix this, we need to make `Method` a descriptor.

This way, when we call `instance.method` first, we are going to call its `__get__()`, on which we bind this callable to the object accordingly (bypassing the object as the first parameter), and then proceed:

```
from types import MethodType

class Method:
    def __init__(self, name):
        self.name = name

    def __call__(self, instance, arg1, arg2):
        print(f"{self.name}: {instance} called with {arg1} and {arg2}")

    def __get__(self, instance, owner):
        if instance is None:
            return self
        return MethodType(self, instance)
```

Now, both calls work as expected:

```
External call: <MyClass object at 0x...> called with first and second
Internal call: <MyClass object at 0x...> called with first and second
```

What we did is convert the `function` (actually the callable object we defined instead) to a method by using `MethodType` from the `types` module. The first parameter of this class should be a callable (`self`, in this case, is one by definition because it implements `__call__`), and the second one is the object to bind this function to.

Something similar to this is what function objects use in Python so they can work as methods when they are defined inside a class.

Since this is a very elegant solution, it's worth exploring it to keep it in mind as a Pythonic approach when defining our own objects. For instance, if we were to define our own callable, it would be a good idea to also make it a descriptor so that we can use it in classes as class attributes as well.

Built-in decorators for methods

As you might have known from looking at the official documentation (PYDESCR-02), all `@property`, `@classmethod`, and `@staticmethod` decorators are descriptors.

We have mentioned several times that the idiom makes the descriptor return itself when it's being called from a class directly. Since properties are actually descriptors, that is the reason why, when we ask it from the class, we don't get the result of computing the property, but the entire `property` object instead:

```
>>> class MyClass:
...     @property
...     def prop(self): pass
...
>>> MyClass.prop
<property object at 0x...>
```

For class methods, the `__get__` function in the descriptor will make sure that the class is the first parameter to be passed to the function being decorated, regardless of whether it's called from the class directly or from an instance. For static methods, it will make sure that no parameters are bound other than those defined by the function, namely undoing the binding done by `__get__()` on functions that make `self` the first parameter of that function.

Let's take an example; we create a `@classproperty` decorator that works as the regular `@property` decorator, but for classes instead. With a decorator like this one, the following code should be able to work:

```
class TableEvent:
    schema = "public"
    table = "user"

    @classproperty
    def topic(cls):
        prefix = read_prefix_from_config()
        return f"{prefix}{cls.schema}.{cls.table}"

>>> TableEvent.topic
'public.user'

>>> TableEvent().topic
'public.user'
```

Slots

When a class defines the `__slots__` attribute, it can contain all the attributes that the class expects and no more.

Trying to add extra attributes dynamically to a class that defines `__slots__` will result in an `AttributeError`. By defining this attribute, the class becomes static, so it will not have a `__dict__` attribute where you can add more objects dynamically.

How, then, are its attributes retrieved if not from the dictionary of the object? By using descriptors. Each name defined in a slot will have its own descriptor that will store the value for retrieval later:

```
class Coordinate2D:
    __slots__ = ("lat", "long")

    def __init__(self, lat, long):
        self.lat = lat
        self.long = long

    def __repr__(self):
        return f"{self.__class__.__name__}({self.lat}, {self.long})"
```

While this is an interesting feature, it has to be used with caution because it is taking away the dynamic nature of Python. In general, this ought to be reserved only for objects that we know are static, and if we are absolutely sure we are not adding any attributes to them dynamically in other parts of the code.

As an upside of this, objects defined with slots use less memory, since they only need a fixed set of fields to hold values and not an entire dictionary.

Implementing descriptors in decorators

We now understand how Python uses descriptors in functions to make them work as methods when they are defined inside a class. We have also seen examples of cases where we can make decorators work by making them comply with the descriptor protocol by using the `__get__()` method of the interface to adapt the decorator to the object it is being called with. This solves the problem for our decorators in the same way that Python solves the issue of functions as methods in objects.

The general recipe for adapting a decorator in such a way is to implement the `__get__()` method on it and use `types.MethodType` to convert the callable (the decorator itself) to a method bound to the object it is receiving (the `instance` parameter received by `__get__`).

For this to work, we will have to implement the decorator as an object, because otherwise, if we are using a function, it will already have a `__get__()` method, which will be doing something different that will not work unless we adapt it. The cleaner way to proceed is to define a class for the decorator.



Use a decorator class when defining a decorator that we want to apply to class methods, and implement the `__get__()` method on it.

Summary

Descriptors are a more advanced feature in Python that push the boundaries, closer to metaprogramming. One of their most interesting aspects is how they make crystal-clear that classes in Python are just regular objects, and, as such, they have properties and we can interact with them. Descriptors are, in this sense, the most interesting type of attribute a class can have because its protocol facilitates more advanced, object-oriented possibilities.

We have seen the mechanics of descriptors, their methods, and how all of this fits together, making a more interesting picture of object-oriented software design. By understanding descriptors, we were able to create powerful abstractions that yield clean and compact classes. We have seen how to fix decorators that we want to apply to functions and methods, we have understood a lot more about how Python works internally, and how descriptors play such a core and critical role in the implementation of the language.

This study of how descriptors are used internally in Python should work as a reference to identify good uses of descriptors in our own code, with the goal of achieving idiomatic solutions.

Despite all of the powerful options that descriptors represent to our advantage, we have to keep in mind when to properly make use of them without over-engineering. In this line, we have suggested that we should reserve the functionality of descriptors for truly generic cases, such as the design of internal development APIs, libraries, or frameworks. Another important consideration along these lines is that, in general, we should not place business logic in descriptors, but rather logic that implements technical functionality to be used by other components that do contain business logic.

Speaking of advanced functionality, the next chapter also covers an interesting and in-depth topic: generators. On the face of it generators are rather simple (and most readers are probably already familiar with them), but what they have in common with descriptors is that they can also be complex, yield a more advanced and elegant design, and make Python a unique language to work with.

References

Here is a list of a few things you can reference for more information:

- Python's official documentation on descriptors (<https://docs.python.org/3/reference/datamodel.html#implementing-descriptors>)
- *WEAKREF 01*: Python weakref module (<https://docs.python.org/3/library/weakref.html>)
- *PYDESCR-02*: Built-in decorators as descriptors (<https://docs.python.org/3/howto/descriptor.html#static-methods-and-class-methods>)

7

Using Generators

Generators are another of those features that makes Python a peculiar language over more traditional ones. In this chapter, we will explore their rationale, why they were introduced in the language, and the problems they solve. We will also cover how to address problems idiomatically by using generators, and how to make our generators (or any iterable, for that matter) Pythonic.

We will understand why iteration (in the form of the iterator pattern) is automatically supported in the language. From there, we will take another journey and explore how generators became such a fundamental feature of Python in order to support other functionality, such as coroutines and asynchronous programming.

The goals for this chapter are as follows:

- To create generators that improve the performance of our programs
- To study how iterators (and the iterator pattern, in particular) are deeply embedded in Python
- To solve problems that involve iteration idiomatically
- To understand how generators work as the basis for coroutines and asynchronous programming
- To explore the syntactic support for coroutines—`yield from`, `await`, and `async def`

Technical requirements

The examples in this chapter will work with any version of Python 3.6 on any platform.

The code used in this chapter can be found at <https://github.com/PacktPublishing/Clean-Code-in-Python>.

The instructions are available in the `README` file.

Creating generators

Generators were introduced in Python a long time ago (PEP-255), with the idea of introducing iteration in Python while improving the performance of the program (by using less memory) at the same time.

The idea of a generator is to create an object that is iterable, and, while it's being iterated, will produce the elements it contains, one at a time. The main use of generators is to save memory—instead of having a very large list of elements in memory, holding everything at once, we have an object that knows how to produce each particular element, one at a time, as they are required.

This feature enables lazy computations or heavyweight objects in memory, in a similar manner to what other functional programming languages (Haskell, for instance) provide. It would even be possible to work with infinite sequences because the lazy nature of generators allows for such an option.

A first look at generators

Let's start with an example. The problem at hand now is that we want to process a large list of records and get some metrics and indicators over them. Given a large data set with information about purchases, we want to process it in order to get the lowest sale, highest sale, and the average price of a sale.

For the simplicity of this example, we will assume a CSV with only two fields, in the following format:

```
<purchase_date>, <price>  
...
```

We are going to create an object that receives all the purchases, and this will give us the necessary metrics. We could get some of these values out of the box by simply using the `min()` and `max()` built-in functions, but that would require iterating all of the purchases more than once, so instead, we are using our custom object, which will get these values in a single iteration.

The code that will get the numbers for us looks rather simple. It's just an object with a method that will process all prices in one go, and, at each step, will update the value of each particular metric we are interested in. First, we will show the first implementation in the following listing, and, later on in this chapter (once we have seen more about iteration), we will revisit this implementation and get a much better (and compact) version of it. For now, we are settling on the following:

```
class PurchasesStats:

    def __init__(self, purchases):
        self.purchases = iter(purchases)
        self.min_price: float = None
        self.max_price: float = None
        self._total_purchases_price: float = 0.0
        self._total_purchases = 0
        self._initialize()

    def _initialize(self):
        try:
            first_value = next(self.purchases)
        except StopIteration:
            raise ValueError("no values provided")

        self.min_price = self.max_price = first_value
        self._update_avg(first_value)

    def process(self):
        for purchase_value in self.purchases:
            self._update_min(purchase_value)
            self._update_max(purchase_value)
            self._update_avg(purchase_value)
        return self

    def _update_min(self, new_value: float):
        if new_value < self.min_price:
            self.min_price = new_value

    def _update_max(self, new_value: float):
        if new_value > self.max_price:
            self.max_price = new_value

    @property
    def avg_price(self):
        return self._total_purchases_price / self._total_purchases

    def _update_avg(self, new_value: float):
        self._total_purchases_price += new_value
```

```
        self._total_purchases += 1

    def __str__(self):
        return (
            f"{self.__class__.__name__}({self.min_price}, "
            f"{self.max_price}, {self.avg_price})"
        )
```

This object will receive all the totals for the purchases and process the required values. Now, we need a function that loads these numbers into something that this object can process. Here is the first version:

```
def _load_purchases(filename):
    purchases = []
    with open(filename) as f:
        for line in f:
            _, price_raw = line.partition(",")
            purchases.append(float(price_raw))

    return purchases
```

This code works; it loads all the numbers of the file into a list that, when passed to our custom object, will produce the numbers we want. It has a performance issue, though. If you run it with a rather large dataset, it will take a while to complete, and it might even fail if the dataset is large enough as to not fit into the main memory.

If we take a look at our code that consumes this data, it is processing the purchases, one at a time, so we might be wondering why our producer fits everything in memory at once. It is creating a list where it puts all of the content of the file, but we know we can do better.

The solution is to create a generator. Instead of loading the entire content of the file in a list, we will produce the results one at a time. The code will now look like this:

```
def load_purchases(filename):
    with open(filename) as f:
        for line in f:
            _, price_raw = line.partition(",")
            yield float(price_raw)
```

If you measure the process this time, you will notice that the usage of memory has dropped significantly. We can also see how the code looks simpler—there is no need to define the list (therefore, there is no need to append to it), and that the `return` statement also disappeared.

In this case, the `load_purchases` function is a generator function, or simply a generator.

In Python, the mere presence of the keyword `yield` in any function makes it a generator, and, as a result, when calling it, nothing other than creating an instance of the generator will happen:

```
>>> load_purchases("file")
<generator object load_purchases at 0x...>
```

A generator object is an iterable (we will revisit iterables in more detail later on), which means that it can work with `for` loops. Notice how we did not have to change anything on the consumer code—our statistics processor remained the same, with the `for` loop unmodified, after the new implementation.

Working with iterables allows us to create these kinds of powerful abstractions that are polymorphic with respect to `for` loops. As long as we keep the iterable interface, we can iterate over that object transparently.

Generator expressions

Generators save a lot of memory, and since they are iterators, they are a convenient alternative to other iterables or containers that require more space in memory such as lists, tuples, or sets.

Much like these data structures, they can also be defined by comprehension, only that it is called a generator expression (there is an ongoing argument about whether they should be called generator comprehensions. In this book, we will just refer to them by their canonical name, but feel free to use whichever you prefer).

In the same way, we would define a list comprehension. If we replace the square brackets with parenthesis, we get a generator that results from the expression. Generator expressions can also be passed directly to functions that work with iterables, such as `sum()`, and, `max()`:

```
>>> [x**2 for x in range(10)]
[0, 1, 4, 9, 16, 25, 36, 49, 64, 81]

>>> (x**2 for x in range(10))
<generator object <genexpr> at 0x...>

>>> sum(x**2 for x in range(10))
285
```



Always pass a generator expression, instead of a list comprehension, to functions that expect iterables, such as `min()`, `max()`, and `sum()`. This is more efficient and pythonic.

Iterating idiomatically

In this section, we will first explore some idioms that come in handy when we have to deal with iteration in Python. These code recipes will help us get a better idea of the types of things we can do with generators (especially after we have already seen generator expressions), and how to solve typical problems in relation to them.

Once we have seen some idioms, we will move on to exploring iteration in Python in more depth, analyzing the methods that make iteration possible, and how iterable objects work.

Idioms for iteration

We are already familiar with the built-in `enumerate()` function that, given an iterable, will return another one on which the element is a tuple, whose first element is the enumeration of the second one (corresponding to the element in the original iterable):

```
>>> list(enumerate("abcdef"))
[(0, 'a'), (1, 'b'), (2, 'c'), (3, 'd'), (4, 'e'), (5, 'f')]
```

We wish to create a similar object, but in a more low-level fashion; one that can simply create an infinite sequence. We want an object that can produce a sequence of numbers, from a starting one, without any limits.

An object as simple as the following one can do the trick. Every time we call this object, we get the next number of the sequence *ad infinitum*:

```
class NumberSequence:
    def __init__(self, start=0):
        self.current = start

    def next(self):
        current = self.current
        self.current += 1
        return current
```

Based on this interface, we would have to use this object by explicitly invoking its `next()` method:

```
>>> seq = NumberSequence()
>>> seq.next()
0
>>> seq.next()
1

>>> seq2 = NumberSequence(10)
>>> seq2.next()
10
>>> seq2.next()
11
```

But with this code, we cannot reconstruct the `enumerate()` function as we would like to, because its interface does not support being iterated over a regular Python `for` loop, which also means that we cannot pass it as a parameter to functions that expect something to iterate over. Notice how the following code fails:

```
>>> list(zip(NumberSequence(), "abcdef"))
Traceback (most recent call last):
  File "...", line 1, in <module>
TypeError: zip argument #1 must support iteration
```

The problem lies in the fact that `NumberSequence` does not support iteration. To fix this, we have to make the object an iterable by implementing the magic method `__iter__()`. We have also changed the previous `next()` method, by using the magic method `__next__`, which makes the object an iterator:

```
class SequenceOfNumbers:

    def __init__(self, start=0):
        self.current = start

    def __next__(self):
        current = self.current
        self.current += 1
        return current

    def __iter__(self):
        return self
```

This has an advantage—not only can we iterate over the element, we also don't even need the `.next()` method any more because having `__next__()` allows us to use the `next()` built-in function:

```
>>> list(zip(SequenceOfNumbers(), "abcdef"))
[(0, 'a'), (1, 'b'), (2, 'c'), (3, 'd'), (4, 'e'), (5, 'f')]
>>> seq = SequenceOfNumbers(100)
>>> next(seq)
100
>>> next(seq)
101
```

The next() function

The `next()` built-in function will advance the iterable to its next element and return it:

```
>>> word = iter("hello")
>>> next(word)
'h'
>>> next(word)
'e' # ...
```

If the iterator does not have more elements to produce, the `StopIteration` exception is raised:

```
>>> ...
>>> next(word)
'o'
>>> next(word)
Traceback (most recent call last):
  File "<stdin>", line 1, in <module>
StopIteration
>>>
```

This exception signals that the iteration is over and that there are no more elements to consume.

If we wish to handle this case, besides catching the `StopIteration` exception, we could provide this function with a default value in its second parameter. Should this be provided, it will be the return value in lieu of throwing `StopIteration`:

```
>>> next(word, "default value")
'default value'
```

Using a generator

The previous code can be simplified significantly by simply using a generator. Generator objects are iterators. This way, instead of creating a class, we can define a function that `yield` the values as needed:

```
def sequence(start=0):
    while True:
        yield start
        start += 1
```

Remember that from our first definition, the `yield` keyword in the body of the function makes it a generator. Because it is a generator, it's perfectly fine to create an infinite loop like this, because, when this generator function is called, it will run all the code until the next `yield` statement is reached. It will produce its value and suspend there:

```
>>> seq = sequence(10)
>>> next(seq)
10
>>> next(seq)
11

>>> list(zip(sequence(), "abcdef"))
[(0, 'a'), (1, 'b'), (2, 'c'), (3, 'd'), (4, 'e'), (5, 'f')]
```

Itertools

Working with iterables has the advantage that the code blends better with Python itself because iteration is a key component of the language. Besides that, we can take full advantage of the `itertools` module (ITER-01). Actually, the `sequence()` generator we just created is fairly similar to `itertools.count()`. However, there is more we can do.

One of the nicest things about iterators, generators, and `itertools`, is that they are composable objects that can be chained together.

For instance, getting back to our first example that processed purchases in order to get some metrics, what if we want to do the same, but only for those values over a certain threshold? The naive approach of solving this problem would be to place the condition while iterating:

```
# ...
def process(self):
    for purchase in self.purchases:
        if purchase > 1000.0:
            ...
```

This is not only non-Pythonic, but it's also rigid (and rigidity is a trait that denotes bad code). It doesn't handle changes very well. What if the number changes now? Do we pass it by parameter? What if we need more than one? What if the condition is different (less than, for instance)? Do we pass a lambda?

These questions should not be answered by this object, whose sole responsibility is to compute a set of well-defined metrics over a stream of purchases represented as numbers. And, of course, the answer is no. It would be a huge mistake to make such a change (once again, clean code is flexible, and we don't want to make it rigid by coupling this object to external factors). These requirements will have to be addressed elsewhere.

It's better to keep this object independent of its clients. The less responsibility this class has, the more useful it will be for more clients, hence enhancing its chances of being reused.

Instead of changing this code, we're going to keep it as it is and assume that the new data is filtered according to whatever requirements each customer of the class has.

For instance, if we wanted to process only the first 10 `purchases` that amount to more than 1,000, we would do the following:

```
>>> from itertools import islice
>>> purchases = islice(filter(lambda p: p > 1000.0, purchases), 10)
>>> stats = PurchasesStats(purchases).process() # ...
```

There is no memory penalization for filtering this way because since they all are generators, the evaluation is always lazy. This gives us the power of thinking as if we had filtered the entire set at once and then passed it to the object, but without actually fitting everything in memory.

Simplifying code through iterators

Now, we will briefly discuss some situations that can be improved with the help of iterators, and occasionally the `itertools` module. After discussing each case, and its proposed optimization, we will close each point with a corollary.

Repeated iterations

Now that we have seen more about iterators, and introduced the `itertools` module, we can show you how one of the first examples of this chapter (the one for computing statistics about some purchases), can be dramatically simplified:

```
def process_purchases(purchases):
    min_, max_, avg = itertools.tee(purchases, 3)
    return min(min_), max(max_), median(avg)
```

In this example, `itertools.tee` will split the original iterable into three new ones. We will use each of these for the different kinds of iterations that we require, without needing to repeat three different loops over `purchases`.

The reader can simply verify that if we pass an iterable object as the `purchases` parameter, this one is traversed only once (thanks to the `itertools.tee` function [see references]), which was our main requirement. It is also possible to verify how this version is equivalent to our original implementation. In this case, there is no need to manually raise `ValueError` because passing an empty sequence to the `min()` function will do the same.



If you are thinking about running a loop over the same object more than one time, stop and think if `itertools.tee` can be of any help.

Nested loops

In some situations, we need to iterate over more than one dimension, looking for a value, and nested loops come as the first idea. When the value is found, we need to stop iterating, but the `break` keyword doesn't work entirely because we have to escape from two (or more) `for` loops, not just one.

What would be the solution for this? A flag signaling escape? No. Raising an exception? No, this would be the same as the flag, but even worse because we know that exceptions are not to be used for control flow logic. Moving the code to a smaller function and return it? Close, but not quite.

The answer is, whenever possible, flat the iteration to a single `for` loop.

This is the kind of code we would like to avoid:

```
def search_nested_bad(array, desired_value):
    coords = None
    for i, row in enumerate(array):
```

```
    for j, cell in enumerate(row):
        if cell == desired_value:
            coords = (i, j)
            break

    if coords is not None:
        break

if coords is None:
    raise ValueError(f"{desired_value} not found")

logger.info("value %r found at [%i, %i]", desired_value, *coords)
return coords
```

And here is a simplified version of it that does not rely on flags to signal termination, and has a simpler, more compact structure of iteration:

```
def _iterate_array2d(array2d):
    for i, row in enumerate(array2d):
        for j, cell in enumerate(row):
            yield (i, j), cell

def search_nested(array, desired_value):
    try:
        coord = next(
            coord
            for (coord, cell) in _iterate_array2d(array)
            if cell == desired_value
        )
    except StopIteration:
        raise ValueError("{desired_value} not found")

    logger.info("value %r found at [%i, %i]", desired_value, *coord)
    return coord
```

It's worth mentioning how the auxiliary generator that was created works as an abstraction for the iteration that's required. In this case, we just need to iterate over two dimensions, but if we needed more, a different object could handle this without the client needing to know about it. This is the essence of the iterator design pattern, which, in Python, is transparent, since it supports iterator objects automatically, which is the topic covered in the next section.



Try to simplify the iteration as much as possible with as many abstractions as are required, flattening the loops whenever possible.

The iterator pattern in Python

Here, we will take a small detour from generators to understand iteration in Python more deeply. Generators are a particular case of iterable objects, but iteration in Python goes beyond generators, and being able to create good iterable objects will give us the chance to create more efficient, compact, and readable code.

In the previous code listings, we have been seeing examples of iterable objects that are also iterators, because they implement both the `__iter__()` and `__next__()` magic methods. While this is fine in general, it's not strictly required that they always have to implement both methods, and here we'll show the subtle differences between an iterable object (one that implements `__iter__`) and an iterator (that implements `__next__`).

We also explore other topics related to iterations, such as sequences and container objects.

The interface for iteration

An iterable is an object that supports iteration, which, at a very high level, means that we can run a `for .. in ...` loop over it, and it will work without any issues. However, iterable does not mean the same as iterator.

Generally speaking, an iterable is just something we can iterate, and it uses an iterator to do so. This means that in the `__iter__` magic method, we would like to return an iterator, namely, an object with a `__next__()` method implemented.

An iterator is an object that only knows how to produce a series of values, one at a time, when it's being called by the already explored built-in `next()` function. While the iterator is not called, it's simply frozen, sitting idly by until it's called again for the next value to produce. In this sense, generators are iterators.

Python concept	Magic method	Considerations
Iterable	<code>__iter__</code>	They work with an iterator to construct the iteration logic. These objects can be iterated in a <code>for ... in ...:</code> loop
Iterator	<code>__next__</code>	Define the logic for producing values one at the time. The <code>StopIteration</code> exception signals that the iteration is over. The values can be obtained one by one via the built-in <code>next()</code> function.

In the following code, we will see an example of an iterator object that is not iterable—it only supports invoking its values, one at a time. Here, the name `sequence` refers just to a series of consecutive numbers, not to the sequence concept in Python, which will we explore later on:

```
class SequenceIterator:
    def __init__(self, start=0, step=1):
        self.current = start
        self.step = step

    def __next__(self):
        value = self.current
        self.current += self.step
        return value
```

Notice that we can get the values of the sequence one at a time, but we can't iterate over this object (this is fortunate because it would otherwise result in an endless loop):

```
>>> si = SequenceIterator(1, 2)
>>> next(si)
1
>>> next(si)
3
>>> next(si)
5
>>> for _ in SequenceIterator(): pass
...
Traceback (most recent call last):
...
TypeError: 'SequenceIterator' object is not iterable
```

The error message is clear, as the object doesn't implement `__iter__()`.

Just for explanatory purposes, we can separate the iteration in another object (again, it would be enough to make the object implement both `__iter__` and `__next__`, but doing so separately will help clarify the distinctive point we're trying to make in this explanation).

Sequence objects as iterables

As we have just seen, if an object implements the `__iter__()` magic method, it means it can be used in a `for` loop. While this is a great feature, it's not the only possible form of iteration we can achieve. When we write a `for` loop, Python will try to see if the object we're using implements `__iter__`, and, if it does, it will use that to construct the iteration, but if it doesn't, there are fallback options.

If the object happens to be a sequence (meaning that it implements `__getitem__()` and `__len__()` magic methods), it can also be iterated. If that is the case, the interpreter will then provide values in sequence, until the `IndexError` exception is raised, which, analogous to the aforementioned `StopIteration`, also signals the stop for the iteration.

With the sole purpose of illustrating such a behavior, we run the following experiment that shows a sequence object that implements `map()` over a range of numbers:

```
# generators_iteration_2.py

class MappedRange:
    """Apply a transformation to a range of numbers."""

    def __init__(self, transformation, start, end):
        self._transformation = transformation
        self._wrapped = range(start, end)

    def __getitem__(self, index):
        value = self._wrapped.__getitem__(index)
        result = self._transformation(value)
        logger.info("Index %d: %s", index, result)
        return result

    def __len__(self):
        return len(self._wrapped)
```

Keep in mind that this example is only designed to illustrate that an object such as this one can be iterated with a regular `for` loop. There is a logging line placed in the `__getitem__` method to explore what values are passed while the object is being iterated, as we can see from the following test:

```
>>> mr = MappedRange(abs, -10, 5)
>>> mr[0]
Index 0: 10
10
>>> mr[-1]
Index -1: 4
4
>>> list(mr)
Index 0: 10
Index 1: 9
Index 2: 8
Index 3: 7
Index 4: 6
Index 5: 5
Index 6: 4
Index 7: 3
```



```
Index 8: 2
Index 9: 1
Index 10: 0
Index 11: 1
Index 12: 2
Index 13: 3
Index 14: 4
[10, 9, 8, 7, 6, 5, 4, 3, 2, 1, 0, 1, 2, 3, 4]
```

As a word of caution, it's important to highlight that while it is useful to know this, it's also a fallback mechanism for when the object doesn't implement `__iter__`, so most of the time we'll want to resort to these methods by thinking in creating proper sequences, and not just objects we want to iterate over.



When thinking about designing an object for iteration, favor a proper iterable object (with `__iter__`), rather than a sequence that can coincidentally also be iterated.

Coroutines

As we already know, generator objects are iterables. They implement `__iter__()` and `__next__()`. This is provided by Python automatically so that when we create a generator object function, we get an object that can be iterated or advanced through the `next()` function.

Besides this basic functionality, they have more methods so that they can work as coroutines (PEP-342). Here, we will explore how generators evolved into coroutines to support the basis of asynchronous programming before we go into more detail in the next section, where we explore the new features of Python and the syntax that covers programming asynchronously. The basic methods added in (PEP-342) to support coroutines are as follows:

- `.close()`
- `.throw(ex_type[, ex_value[, ex_traceback]])`
- `.send(value)`

The methods of the generator interface

In this section, we will explore what each of the aforementioned methods does, how it works, and how it is expected to be used. By understanding how to use these methods, we will be able to make use of simple coroutines.

Later on, we will explore more advanced uses of coroutines, and how to delegate to sub-generators (coroutines) in order to refactor code, and how to orchestrate different coroutines.

close()

When calling this method, the generator will receive the `GeneratorExit` exception. If it's not handled, then the generator will finish without producing any more values, and its iteration will stop.

This exception can be used to handle a finishing status. In general, if our coroutine does some sort of resource management, we want to catch this exception and use that control block to release all resources being held by the coroutine. In general, it is similar to using a context manager or placing the code in the `finally` block of an exception control, but handling this exception specifically makes it more explicit.

In the following example, we have a coroutine that makes use of a database handler object that holds a connection to a database, and runs queries over it, streaming data by pages of a fixed length (instead of reading everything that is available at once):

```
def stream_db_records(db_handler):
    try:
        while True:
            yield db_handler.read_n_records(10)
    except GeneratorExit:
        db_handler.close()
```

At each call to the generator, it will return 10 rows obtained from the database handler, but when we decide to explicitly finish the iteration and call `close()`, we also want to close the connection to the database:

```
>>> streamer = stream_db_records(DBHandler("testdb"))
>>> next(streamer)
[(0, 'row 0'), (1, 'row 1'), (2, 'row 2'), (3, 'row 3'), ...]
>>> next(streamer)
[(0, 'row 0'), (1, 'row 1'), (2, 'row 2'), (3, 'row 3'), ...]
>>> streamer.close()
INFO:...:closing connection to database 'testdb'
```



Use the `close()` method on generators to perform finishing-up tasks when needed.

`throw(ex_type[, ex_value[, ex_traceback]])`

This method will `throw` the exception at the line where the generator is currently suspended. If the generator handles the exception that was sent, the code in that particular `except` clause will be called, otherwise, the exception will propagate to the caller.

Here, we are modifying the previous example slightly to show the difference when we use this method for an exception that is handled by the coroutine, and when it's not:

```
class CustomException(Exception):
    pass

def stream_data(db_handler):
    while True:
        try:
            yield db_handler.read_n_records(10)
        except CustomException as e:
            logger.info("controlled error %r, continuing", e)
        except Exception as e:
            logger.info("unhandled error %r, stopping", e)
            db_handler.close()
            break
```

Now, it is a part of the control flow to receive a `CustomException`, and, in such a case, the generator will log an informative message (of course, we can adapt this according to our business logic on each case), and move on to the next `yield` statement, which is the line where the coroutine reads from the database and returns that data.

This particular example handles all exceptions, but if the last block (`except Exception:`) wasn't there, the result would be that the generator is raised at the line where the generator is paused (again, the `yield`), and it will propagate from there to the caller:

```
>>> streamer = stream_data(DBHandler("testdb"))
>>> next(streamer)
[(0, 'row 0'), (1, 'row 1'), (2, 'row 2'), (3, 'row 3'), (4, 'row 4'), ...]
>>> next(streamer)
[(0, 'row 0'), (1, 'row 1'), (2, 'row 2'), (3, 'row 3'), (4, 'row 4'), ...]
>>> streamer.throw(CustomException)
```

```
WARNING:controlled error CustomException(), continuing
[(0, 'row 0'), (1, 'row 1'), (2, 'row 2'), (3, 'row 3'), (4, 'row 4'), ...]
>>> streamer.throw(RuntimeError)
ERROR:unhandled error RuntimeError(), stopping
INFO:closing connection to database 'testdb'
Traceback (most recent call last):
...
StopIteration
```

When our exception from the domain was received, the generator continued. However, when it received another exception that was not expected, the default block caught where we closed the connection to the database and finished the iteration, which resulted in the generator being stopped. As we can see from the `StopIteration` that was raised, this generator can't be iterated further.

send(value)

In the previous example, we created a simple generator that reads rows from a database, and when we wished to finish its iteration, this generator released the resources linked to the database. This is a good example of using one of the methods that generators provide (`close`), but there is more we can do.

An obvious of such a generator is that it was reading a fixed number of rows from the database.

We would like to parametrize that number (10) so that we can change it throughout different calls. Unfortunately, the `next()` function does not provide us with options for that. But luckily, we have `send()`:

```
def stream_db_records(db_handler):
    retrieved_data = None
    previous_page_size = 10
    try:
        while True:
            page_size = yield retrieved_data
            if page_size is None:
                page_size = previous_page_size

            previous_page_size = page_size

            retrieved_data = db_handler.read_n_records(page_size)
    except GeneratorExit:
        db_handler.close()
```

The idea is that we have now made the coroutine able to receive values from the caller by means of the `send()` method. This method is the one that actually distinguishes a generator from a coroutine because when it's used, it means that the `yield` keyword will appear on the right-hand side of the statement, and its return value will be assigned to something else.

In coroutines, we generally find the `yield` keyword to be used in the following form:

```
receive = yield produced
```

The `yield`, in this case, will do two things. It will send `produced` back to the caller, which will pick it up on the next round of iteration (after calling `next()`, for example), and it will suspend there. At a later point, the caller will want to send a value back to the coroutine by using the `send()` method. This value will become the result of the `yield` statement, assigned in this case to the variable named `receive`.

Sending values to the coroutine only works when this one is suspended at a `yield` statement, waiting for something to produce. For this to happen, the coroutine will have to be advanced to that status. The only way to do this is by calling `next()` on it. This means that before sending anything to the coroutine, this has to be advanced at least once via the `next()` method. Failure to do so will result in an exception:

```
>>> c = coro()
>>> c.send(1)
Traceback (most recent call last):
...
TypeError: can't send non-None value to a just-started generator
```



Always remember to advance a coroutine by calling `next()` before sending any values to it.

Back to our example. We are changing the way elements are produced or streamed to make it able to receive the length of the records it expects to read from the database.

The first time we call `next()`, the generator will advance up to the line containing `yield`; it will provide a value to the caller (`None`, as set in the variable), and it will suspend there). From here, we have two options. If we choose to advance the generator by calling `next()`, the default value of `10` will be used, and it will go on with this as usual. This is because `next()` is technically the same as `send(None)`, but this is covered in the `if` statement that will handle the value that we previously set.

If, on the other hand, we decide to provide an explicit value via `send(<value>)`, this one will become the result of the `yield` statement, which will be assigned to the variable containing the length of the page to use, which, in turn, will be used to read from the database.

Successive calls will have this logic, but the important point is that now we can dynamically change the length of the data to read in the middle of the iteration, at any point.

Now that we understand how the previous code works, most Pythonistas would expect a simplified version of it (after all, Python is also about brevity and clean and compact code):

```
def stream_db_records(db_handler):
    retrieved_data = None
    page_size = 10
    try:
        while True:
            page_size = (yield retrieved_data) or page_size
            retrieved_data = db_handler.read_n_records(page_size)
    except GeneratorExit:
        db_handler.close()
```

This version is not only more compact, but it also illustrates the idea better. The parenthesis around the `yield` makes it clearer that it's a statement (think of it as if it were a function call), and that we are using the result of it to compare it against the previous value.

This works as we expect it does, but we always have to remember to advance the coroutine before sending any data to it. If we forget to call the first `next()`, we'll get a `TypeError`. This call could be ignored for our purposes because it doesn't return anything we'll use.

It would be good if we could use the coroutine directly, right after it is created without having to remember to call `next()` the first time, every time we are going to use it. Some authors (PYCOOK) devised an interesting decorator to achieve this. The idea of this decorator is to advance the coroutine, so the following definition works automatically:

```
@prepare_coroutine
def stream_db_records(db_handler):
    retrieved_data = None
    page_size = 10
    try:
        while True:
            page_size = (yield retrieved_data) or page_size
            retrieved_data = db_handler.read_n_records(page_size)
    except GeneratorExit:
        db_handler.close()
```

```
>>> streamer = stream_db_records(DBHandler("testdb"))
>>> len(streamer.send(5))
5
```

Let's take an example we create the `prepare_coroutine()`, decorator.

More advanced coroutines

So far, we have a better understanding of coroutines, and we are able to create simple ones to handle small tasks. We can say that these coroutines are, in fact, just more advanced generators (and that would be right, coroutines are just fancy generators), but, if we actually want to start supporting more complex scenarios, we usually have to go for a design that handles many coroutines concurrently, and that requires more features.

When handling many coroutines, we find new problems. As the control flow of our application becomes more complex, we want to pass values up and down the stack (as well as exceptions), be able to capture values from sub-coroutines we might call at any level, and finally schedule multiple coroutines to run toward a common goal.

To make things simpler, generators had to be extended once again. This is what PEP-380 addressed—by changing the semantic of generators so that they are able to return values, and introducing the new `yield from` construction.

Returning values in coroutines

As introduced at the beginning of this chapter, the iteration is a mechanism that calls `next()` on an iterable object many times until a `StopIteration` exception is raised.

So far, we have been exploring the iterative nature of generators—we produce values one at a time, and, in general, we only care about each value as it's being produced at every step of the `for` loop. This is a very logical way of thinking about generators, but coroutines have a different idea; even though they are technically generators, they weren't conceived with the idea of iteration in mind, but with the goal of suspending the execution of a code until it's resumed later on.

This is an interesting challenge; when we design a coroutine, we usually care more about suspending the state rather than iterating (and iterating a coroutine would be an odd case). The challenge lies in that it is easy to mix them both. This is because of a technical implementation detail; the support for coroutines in Python was built upon generators.

If we want to use coroutines to process some information and suspend its execution, it would make sense to think of them as lightweight threads (or green threads, as they are called in other platforms). In such a case, it would make sense if they could return values, much like calling any other regular function.

But let's remember that generators are not regular functions, so in a generator, the construction `value = generator()` will do nothing other than create a `generator` object. What would be the semantics for making a generator return a value? It will have to be after the iteration is done.

When a generator returns a value, its iteration is immediately stopped (it can't be iterated any further). To preserve the semantics, the `StopIteration` exception is still raised, and the value to be returned is stored inside the `exception` object. It's the responsibility of the caller to catch it.

In the following example, we are creating a simple `generator` that produces two values and then returns a third. Notice how we have to catch the exception in order to get this `value`, and how it's stored precisely inside the exception under the attribute named `value`:

```
>>> def generator():
...     yield 1
...     yield 2
...     return 3
...
>>> value = generator()
>>> next(value)
1
>>> next(value)
2
>>> try:
...     next(value)
... except StopIteration as e:
...     print(">>>>> returned value ", e.value)
...
>>>>> returned value 3
```

Delegating into smaller coroutines – the `yield` from syntax

The previous feature is interesting in the sense that it opens up a lot of new possibilities with coroutines (generators), now that they can return values. But this feature, by itself, would not be so useful without proper syntax support, because catching the returned value this way is a bit cumbersome.

This is one of the main features of the `yield from` syntax. Among other things (that we'll review in detail), it can collect the value returned by a sub-generator. Remember that we said that returning data in a generator was nice, but that, unfortunately, writing statements as `value = generator()` wouldn't work? Well, writing it as `value = yield from generator()` would.

The simplest use of `yield from`

In its most basic form, the new `yield from` syntax can be used to chain generators from nested `for` loops into a single one, which will end up with a single string of all the values in a continuous stream.

The canonical example is about creating a function similar to `itertools.chain()` from the `standard` library. This is a very nice function because it allows you to pass any number of `iterables`, and will return them all together in one stream.

The naive implementation might look like this:

```
def chain(*iterables):
    for it in iterables:
        for value in it:
            yield value
```

It receives a variable number of `iterables`, traverses through all of them, and since each value is `iterable`, it supports a `for... in..` construction, so we have another `for` loop to get every value inside each particular iterable, which is produced by the caller function. This might be helpful in multiple cases, such as chaining generators together or trying to iterate things that it wouldn't normally be possible to compare in one go (such as lists with tuples, and so on).

However, the `yield from` syntax allows us to go further and avoid the nested loop because it's able to produce the values from a sub-generator directly. In this case, we could simplify the code like this:

```
def chain(*iterables):
    for it in iterables:
        yield from it
```

Notice that for both implementations, the behavior of the generator is exactly the same:

```
>>> list(chain("hello", ["world"], ("tuple", " of ", "values.")))
['h', 'e', 'l', 'l', 'o', 'world', 'tuple', ' of ', 'values.']
```

This means that we can use `yield from` over any other iterable, and it will work as if the top-level generator (the one the `yield from` is using) were generating those values itself.

This works with any iterable, and even generator expressions aren't the exception. Now that we're familiar with its syntax, let's see how we could write a simple generator function that will produce all the powers of a number (for instance, if provided with `all_powers(2, 3)`, it will have to produce $2^0, 2^1, \dots, 2^3$):

```
def all_powers(n, pow):
    yield from (n ** i for i in range(pow + 1))
```

While this simplifies the syntax a bit, saving one line of a `for` statement isn't a big advantage, and it wouldn't justify adding such a change to the language.

Indeed, this is actually just a side effect and the real *raison d'être* of the `yield from` construction is what we are going to explore in the following two sections.

Capturing the value returned by a sub-generator

In the following example, we have a generator that calls another two nested generators, producing values in a sequence. Each one of these nested generators returns a value, and we will see how the top-level generator is able to effectively capture the return value since it's calling the internal generators through `yield from`:

```
def sequence(name, start, end):
    logger.info("%s started at %i", name, start)
    yield from range(start, end)
    logger.info("%s finished at %i", name, end)
    return end

def main():
    step1 = yield from sequence("first", 0, 5)
    step2 = yield from sequence("second", step1, 10)
    return step1 + step2
```

This is a possible execution of the code in `main` while it's being iterated:

```
>>> g = main()
>>> next(g)
INFO:generators_yieldfrom_2:first started at 0
0
>>> next(g)
1
>>> next(g)
2
>>> next(g)
```

```
3
>>> next(g)
4
>>> next(g)
INFO:generators_yieldfrom_2:first finished at 5
INFO:generators_yieldfrom_2:second started at 5
5
>>> next(g)
6
>>> next(g)
7
>>> next(g)
8
>>> next(g)
9
>>> next(g)
INFO:generators_yieldfrom_2:second finished at 10
Traceback (most recent call last):
  File "<stdin>", line 1, in <module>
StopIteration: 15
```

The first line of main delegates into the internal generator, and produces the values, extracting them directly from it. This is nothing new, as we have already seen. Notice, though, how the `sequence()` generator function returns the end value, which is assigned in the first line to the variable named `step1`, and how this value is correctly used at the start of the following instance of that generator.

In the end, this other generator also returns the second end value (10), and the main generator, in turn, returns the sum of them ($5+10=15$), which is the value we see once the iteration has stopped.



We can use `yield from` to capture the last value of a coroutine after it has finished its processing.

Sending and receiving data to and from a sub-generator

Now, we will see the other nice feature of the `yield from` syntax, which is probably what gives it its full power. As we have already introduced when we explored generators acting as coroutines, we know that we can send values and throw exceptions at them, and, in such cases, the coroutine will either receive the value for its internal processing, or it will have to handle the exception accordingly.

If we now have a coroutine that delegates into other ones (such as in the previous example), we would also like to preserve this logic. Having to do so manually would be quite complex (you can take a look at the code described in PEP-380 if we didn't have this handled by `yield from` automatically).

In order to illustrate this, let's keep the same top-level generator (main) unmodified with respect to the previous example (calling other internal generators), but let's modify the internal generators to make them able to receive values and handle exceptions. The code is probably not idiomatic, only for the purposes of showing how this mechanism works:

```
def sequence(name, start, end):
    value = start
    logger.info("%s started at %i", name, value)
    while value < end:
        try:
            received = yield value
            logger.info("%s received %r", name, received)
            value += 1
        except CustomException as e:
            logger.info("%s is handling %s", name, e)
            received = yield "OK"
    return end
```

Now, we will call the main coroutine, not only by iterating it, but also by passing values and throwing exceptions at it to see how they are handled inside `sequence`:

```
>>> g = main()
>>> next(g)
INFO: first started at 0
0
>>> next(g)
INFO: first received None
1
>>> g.send("value for 1")
INFO: first received 'value for 1'
2
>>> g.throw(CustomException("controlled error"))
INFO: first is handling controlled error
'OK'
... # advance more times
INFO:second started at 5
5
>>> g.throw(CustomException("exception at second generator"))
INFO: second is handling exception at second generator
'OK'
```

This example is showing us a lot of different things. Notice how we never send values to `sequence`, but only to `main`, and even so, the code that is receiving those values is the nested generators. Even though we never explicitly send anything to `sequence`, it's receiving the data as it's being passed along by `yield from`.

The `main` coroutine calls two other coroutines internally, producing their values, and it will be suspended at a particular point in time in any of those. When it's stopped at the first one, we can see the logs telling us that it is that instance of the coroutine that received the value we sent. The same happens when we throw an exception to it. When the first coroutine finishes, it returns the value that was assigned in the variable named `step1`, and passed as input for the second coroutine, which will do the same (it will handle the `send()` and `throw()` calls, accordingly).

The same happens for the values that each coroutine produces. When we are at any given step, the return from calling `send()` corresponds to the value that the subcoroutine (the one that `main` is currently suspended at) has produced. When we throw an exception that is being handled, the `sequence` coroutine produces the value `OK`, which is propagated to the called (`main`), and which in turn will end up at `main`'s caller.

Asynchronous programming

With the constructions we have seen so far, we are able to create asynchronous programs in Python. This means that we can create programs that have many coroutines, schedule them to work in a particular order, and switch between them when they're suspended after a `yield from` has been called on each of them.

The main advantage that we can take out of this is the possibility of parallelizing I/O operations in a non-blocking way. What we would need is a low-level generator (usually implemented by a third-party library) that knows how to handle the actual I/O while the coroutine is suspended. The idea is for the coroutine to effect suspension so that our program can handle another task in the meantime. The way the application would retrieve the control back is by means of the `yield from` statement, which will suspend and produce a value to the caller (as in the examples we saw previously when we used this syntax to alter the control flow of the program).

This is roughly the way asynchronous programming had been working in Python for quite a few years, until it was decided that better syntactic support was needed.

The fact that coroutines and generators are technically the same causes some confusion. Syntactically (and technically), they are the same, but semantically, they are different. We create generators when we want to achieve efficient iteration. We typically create coroutines with the goal of running non-blocking I/O operations.

While this difference is clear, the dynamic nature of Python would still allow developers to mix these different type of objects, ending up with a runtime error at a very late stage of the program. Remember that in the simplest and most basic form of the `yield from` syntax, we used this construction over iterables (we created a sort of `chain` function applied over strings, lists, and so on). None of these objects were coroutines, and it still worked. Then, we saw that we can have multiple coroutines, use `yield from` to send the value (or exceptions), and get some results back. These are clearly two very different use cases, however, if we write something along the lines of the following statement:

```
result = yield from iterable_or_awaitable()
```

It's not clear what `iterable_or_awaitable` returns. It can be a simple iterable such as a string, and it might still be syntactically correct. Or, it might be an actual coroutine. The cost of this mistake will be paid much later.

For this reason, the typing system in Python had to be extended. Before Python 3.5, coroutines were just generators with a `@coroutine` decorator applied, and they were to be called with the `yield from` syntax. Now, there is a specific type of object, that is, a coroutine.

This change heralded, syntax changes as well. The `await` and `async def` syntax were introduced. The former is intended to be used instead of `yield from`, and it only works with `awaitable` objects (which coroutines conveniently happen to be). Trying to call `await` with something that doesn't respect the interface of an `awaitable` will raise an exception. The `async def` is the new way of defining coroutines, replacing the aforementioned decorator, and this actually creates an object that, when called, will return an instance of a coroutine.

Without going into all the details and possibilities of asynchronous programming in Python, we can say that despite the new syntax and the new types, this is not doing anything fundamentally different from concepts we have covered in this chapter.

The idea of programming asynchronously in Python is that there is an `event loop` (typically `asyncio` because it's the one that is included in the `standard library`, but there are many others that will work just the same) that manages a series of coroutines. These coroutines belong to the event loop, which is going to call them according to its scheduling mechanism. When each one of these runs, it will call our code (according to the logic we have defined inside the coroutine we programmed), and when we want to get control back to the event loop, we call `await <coroutine>`, which will process a task asynchronously. The event loop will resume and another coroutine will take place while that operation is left running.

In practice, there are more particularities and edge cases that are beyond the scope of this book. It is, however, worth mentioning that these concepts are related to the ideas introduced in this chapter and that this arena is another place where generators demonstrate being a core concept of the language, as there are many things constructed on top of them.

Summary

Generators are everywhere in Python. Since their inception in Python a long time ago, they proved to be a great addition that makes programs more efficient and iteration much simpler.

As time moved on, and more complex tasks needed to be added to Python, generators helped again in supporting coroutines.

And, while in Python, coroutines are generators, we still don't have to forget that they're semantically different. Generators are created with the idea of iteration, while coroutines have the goal of asynchronous programming (suspending and resuming the execution of a part of our program at any given time). This distinction became so important that it made Python's syntax (and type system) evolve.

Iteration and asynchronous programming constitute the last of the main pillars of Python programming. Now, it's time to see how everything fits together and to put all of these concepts we have been exploring over the past few chapters into action.

The following chapters will describe other fundamental aspects of Python projects, such as testing, design patterns, and architecture.

References

Here is a list of information you can refer to:

- **PEP-234: Iterators** (<https://www.python.org/dev/peps/pep-0234/>)
- **PEP-255: Simple Generators** (<https://www.python.org/dev/peps/pep-0255/>)
- **ITER-01: Python's itertools module** (<https://docs.python.org/3/library/itertools.html>)
- **GoF: The book** written by Erich Gamma, Richard Helm, Ralph Johnson, John Vlissides named *Design Patterns: Elements of Reusable Object-Oriented Software*
- **PEP-342: Coroutines via Enhanced Generators** (<https://www.python.org/dev/peps/pep-0342/>)
- **PYCOOK: The book** written by Brian Jones, David Beazley named *Python Cookbook: Recipes for Mastering Python 3, Third Edition*
- **PY99: Fake threads (generators, coroutines, and continuations)** (<https://mail.python.org/pipermail/python-dev/1999-July/000467.html>)
- **CORO-01: Co Routine** (<http://wiki.c2.com/?CoRoutine>)
- **CORO-02: Generators Are Not Coroutines** (<http://wiki.c2.com/?GeneratorsAreNotCoroutines>)
- **TEE: The `itertools.tee` function** (<https://docs.python.org/3/library/itertools.html#itertools.tee>)

8

Unit Testing and Refactoring

The ideas explored in this chapter are fundamental pillars in the global context of the book, because of their importance towards our ultimate goal: to write better and more maintainable software.

Unit tests (and any form of automatic tests, for that matter) are critical to software maintainability, and therefore are something that cannot be missing from any quality project. It is for that reason that this chapter is dedicated exclusively to aspects of automated testing as a key strategy, to safely modify the code, and iterate over it, in incrementally better versions.

After this chapter, we will have gained more insight into the following:

- Why automated tests are critical for projects that run under an agile software development methodology
- How unit tests work as a heuristic of the quality of the code
- What frameworks and tools are available to develop automated tests and set up quality gates
- Taking advantage of unit tests to understand the domain problem better and document code
- Concepts related to unit testing, such as test-driven development

Design principles and unit testing

In this section, we first going to take a look at unit testing from a conceptual point of view. We will revisit some of the software engineering principles we discussed in the previous to get an idea of how this is related to clean code.

After that, we will discuss in more detail how to put these concepts into practice (at the code level), and what frameworks and tools we can make use of.

First we quickly define what unit testing is about. Unit tests are parts of the code in charge of validating other parts of the code. Normally, anyone would be tempted to say that unit tests, validate the "core" of the application, but such definition regards unit tests to a secondary place, which is not the way they are thought of in this book. Unit tests are core, and a critical component of the software and they should be treated with the same considerations as the business logic.

A unit tests is a piece of code that imports parts of the code with the business logic, and exercises its logic, asserting several scenarios with the idea to guarantee certain conditions. There are some traits that unit tests must have, such as:

- **Isolation:** unit test should be completely independent from any other external agent, and they have to focus only on the business logic. For this reason, they do not connect to a database, they don't perform HTTP requests, etc. Isolation also means that the tests are independent among themselves: they must be able to run in any order, without depending on any previous state.
- **Performance:** unit tests must run quickly. They are intended to be run multiple times, repeatedly.
- **Self-validating:** The execution of a unit tests determines its result. There should be no extra step required to interpret the unit test (much less manual).

More concretely, in Python this means that we will have new `*.py` files where we are going to place our unit tests, and they are going to be called by some tool. These files will have `import` statements, to take what we need from our business logic (what we intend to test), and inside this file we program the tests themselves. Afterwards, a tool will collect our unit tests and run them, giving a result.

This last part is what self-validation actually means. When the tool calls our files, a Python process will be launched, and our tests will be running on it. If the tests fail, the process will have exited with an error code (in a Unix environment, this can be any number different than 0). The standard is that the tool runs the test, and prints a dot (.) for every successful test, an `F` if the test failed (the condition of the test was not satisfied), and an `E` if there was an exception.

A note about other forms of automated testing

Unit tests are intended to verify very small units, for example a function, or a method. We want from our unit tests to reach a very detailed level of granularity, testing as much code as possible. To test a class we would not want to use a unit tests, but rather a test suite, which is a collection of unit tests. Each one of them will be testing something more specific, like a method of that class.

This is not the only form of unit tests, and it cannot catch every possible error. There are also acceptance and integration tests, both out of the scope of this book.

In an integration test, we will want to test multiple components at once. In this case we want to validate if collectively, they work as expected. In this case is acceptable (more than that, desirable) to have side-effects, and to forget about isolation, meaning that we will want to issue HTTP requests, connect to databases, and so on.

An acceptance test is an automated form of testing that tries to validate the system from the perspective of an user, typically executing use cases.

These two last forms of testing lose another nice trait with respect of unit tests: velocity. As you can imagine, they will take more time to run, therefore they will be run less frequently.

In a good development environment, the programmer will have the entire test suite, and will run unit tests all the time, repeatedly, while he or she is making changes to the code, iterating, refactoring, and so on. Once the changes is ready, and the pull request is open, the continuous integration service will run the build for that branch, where the unit tests will run, as long as the integration or acceptance tests that might exist. Needless to say, the status of the build should be successful (green) before merging, but the important part is the difference between the kind of tests: we want to run unit tests all the time, and less frequently those test that take longer. For this reason, we want to have a lot of small unit tests, and a few automated tests, strategically designed to cover as much as possible of where the unit tests could not reach (the database, for instance).

Finally, a word to the wise. Remember that this book encourages pragmatism. Besides these definitions give, and the points made about unit tests in the beginning of the section, the reader has to keep in mind that the best solution according to your criteria and context, should predominate. Nobody knows your system better than you. Which means, if for some reason you have to write an unit tests that needs to launch a Docker container to test against a database, go for it. As we have repeatedly remembered throughout the book, *practicality beats purity*.

Unit testing and agile software development

In modern software development, we want to deliver value constantly, and as quickly as possible. The rationale behind these goals is that the earlier we get feedback, the less the impact, and the easier it will be to change. These are no new ideas at all; some of them resemble manufacturing principles from decades ago, and others (such as the idea of getting feedback from stakeholders as soon as possible and iterating upon it) you can find in essays such as *The Cathedral and the Bazaar* (abbreviated as *CatB*).

Therefore, we want to be able to respond effectively to changes, and for that, the software we write will have to change. Like we mentioned in the previous chapters, we want our software to be adaptable, flexible, and extensible.

The code alone (regardless of how well written and designed it is) cannot guarantee us that it's flexible enough to be changed. Let's say we design a piece of software following the SOLID principles, and in one part we actually have a set of components that comply with the open/closed principle, meaning that we can easily extend them without affecting too much existing code. Assume further that the code is written in a way that favors refactoring, so we could change it as required. What's to say that when we make these changes, we aren't introducing any bugs? How do we know that existing functionality is preserved? Would you feel confident enough releasing that to your users? Will they believe that the new version works just as expected?

The answer to all of these questions is that we can't be sure unless we have a formal proof of it. And unit tests are just that, formal proof that the program works according to the specification.

Unit (or automated) tests, therefore, work as a safety net that gives us the confidence to work on our code. Armed with these tools, we can efficiently work on our code, and therefore this is what ultimately determines the velocity (or capacity) of the team working on the software product. The better the tests, the more likely it is we can deliver value quickly without being stopped by bugs every now and then.

Unit testing and software design

This is the other face of the coin when it comes to the relationship between the main code and unit testing. Besides the pragmatic reasons explored in the previous section, it comes down to the fact that good software is testable software. **Testability** (the quality attribute that determines how easy to test software is) is not just a nice to have, but a driver for clean code.

Unit tests aren't just something complementary to the main code base, but rather something that has a direct impact and real influence on how the code is written. There are many levels of this, from the very beginning when we realize that the moment we want to add unit tests for some parts of our code, we have to change it (resulting in a better version of it), to its ultimate expression (explored near the end of this chapter) when the entire code (the design) is driven by the way it's going to be tested via **test-driven design**.

Starting off with a simple example, we will show you a small use case in which tests (and the need to test our code) lead to improvements in the way our code ends up being written.

In the following example, we will simulate a process that requires sending metrics to an external system about the results obtained at each particular task (as always, details won't make any difference as long as we focus on the code). We have a `Process` object that represents some task on the domain problem, and it uses a `MetricsClient` (an external dependency and therefore something we don't control) to send the actual metrics to the external entity (that this could be sending data to `syslog`, or `statsd`, for instance):

```
class MetricsClient:
    """3rd-party metrics client"""

    def send(self, metric_name, metric_value):
        if not isinstance(metric_name, str):
            raise TypeError("expected type str for metric_name")

        if not isinstance(metric_value, str):
            raise TypeError("expected type str for metric_value")

        logger.info("sending %s = %s", metric_name, metric_value)

class Process:

    def __init__(self):
        self.client = MetricsClient() # A 3rd-party metrics client

    def process_iterations(self, n_iterations):
        for i in range(n_iterations):
            result = self.run_process()
            self.client.send("iteration.{}".format(i), result)
```

In the simulated version of the third-party client, we put the requirement that the parameters provided must be of type string. Therefore, if the `result` of the `run_process` method is not a string, we might expect it to fail, and indeed it does:

```
Traceback (most recent call last):
...
  raise TypeError("expected type str for metric_value")
TypeError: expected type str for metric_value
```

Remember that this validation is out of our hands and we cannot change the code, so we must provide the method with parameters of the correct type before proceeding. But since this is a bug we detected, we first want to write a unit test to make sure it will not happen again. We do this to actually prove that we fixed the issue, and to protect against this bug in the future, regardless of how many times the code is refactored.

It would be possible to test the code as is by mocking the client of the `Process` object (we will see how to do so in the section about mock objects, when we explore the tools for unit testing), but doing so runs more code than is needed (notice how the part we want to test is nested into the code). Moreover, it's good that the method is relatively small, because if it weren't, the test would have to run even more undesired parts that we might also need to mock. This is another example of good design (small, cohesive functions or methods), that relates to testability.

Finally, we decide not to go to much trouble and test just the part that we need to, so instead of interacting with the `client` directly on the main method, we delegate to a wrapper method, and the new class looks like this:

```
class WrappedClient:

    def __init__(self):
        self.client = MetricsClient()

    def send(self, metric_name, metric_value):
        return self.client.send(str(metric_name), str(metric_value))

class Process:
    def __init__(self):
        self.client = WrappedClient()

    ... # rest of the code remains unchanged
```

In this case, we opted for creating our own version of the `client` for metrics, that is, a wrapper around the third-party library one we used to have. To do this, we place a class that (with the same interface) will make the conversion of the types accordingly.

This way of using composition resembles the adapter design pattern (we'll explore design patterns in the next chapter, so, for now, it's just an informative message), and since this is a new object in our domain, it can have its respective unit tests. Having this object will make things simpler to test, but more importantly, now that we look at it, we realize that this is probably the way the code should have been written in the first place. Trying to write a unit test for our code made us realize that we were missing an important abstraction entirely!

Now that we have separated the method as it should be, let's write the actual unit test for it. The details about the `unittest` module used in this example will be explored in more detail in the part of the chapter where we explore testing tools and libraries, but for now reading the code will give us a first impression on how to test it, and it will make the previous concepts a little less abstract:

```
import unittest
from unittest.mock import Mock

class TestWrappedClient(unittest.TestCase):
    def test_send_converts_types(self):
        wrapped_client = WrappedClient()
        wrapped_client.client = Mock()
        wrapped_client.send("value", 1)

        wrapped_client.client.send.assert_called_with("value", "1")
```

`Mock` is a type that's available in the `unittest.mock` module, which is a quite convenient object to ask about all sort of things. For example, in this case, we're using it in place of the third-party library (mocked into the boundaries of the system, as commented on the next section) to check that it's called as expected (and once again, we're not testing the library itself, only that it is called correctly). Notice how we run a call like the one our `Process` object, but we expect the parameters to be converted to strings.

Defining the boundaries of what to test

Testing requires effort. And if we are not careful when deciding what to test, we will never end testing, hence wasting a lot of effort without achieving much.

We should scope the testing to the boundaries of our code. If we don't, we would have to also test the dependencies (external/third-party libraries or modules) or our code, and then their respective dependencies, and so on and so forth in a never-ending journey. It's not our responsibility to test dependencies, so we can assume that these projects have tests of their own. It would be enough just to test that the correct calls to external dependencies are done with the correct parameters (and that might even be an acceptable use of patching), but we shouldn't put more effort in than that.

This is another instance where good software design pays off. If we have been careful in our design, and clearly defined the boundaries of our system (that is, we designed towards interfaces, instead of concrete implementations that will change, hence inverting the dependencies over external components to reduce temporal coupling), then it will be much more easier to mock these interfaces when writing unit tests.

In good unit testing, we want to patch on the boundaries of our system and focus on the core functionality to be exercised. We don't test external libraries (third-party tools installed via `pip`, for instance), but instead, we check that they are called correctly. When we explore `mock` objects later on in this chapter, we will review techniques and tools for performing these types of assertion.

Frameworks and tools for testing

There are a lot of tools we can use for writing out unit tests, all of them with pros and cons and serving different purposes. But among all of them, there are two that will most likely cover almost every scenario, and therefore we limit this section to just them.

Along with testing frameworks and test running libraries, it's often common to find projects that configure code coverage, which they use as a quality metric. Since coverage (when used as a metric) is misleading, after seeing how to create unit tests we'll discuss why it's not to be taken lightly.

Frameworks and libraries for unit testing

In this section, we will discuss two frameworks for writing and running unit tests. The first one, `unittest`, is available in the standard library of Python, while the second one, `pytest`, has to be installed externally via `pip`.

- `unittest`: <https://docs.python.org/3/library/unittest.html>
- `pytest`: <https://docs.pytest.org/en/latest/>

When it comes to covering testing scenarios for our code, `unittest` alone will most likely suffice, since it has plenty of helpers. However, for more complex systems on which we have multiple dependencies, connections to external systems, and probably the need to patch objects, and define fixtures parameterize test cases, then `pytest` looks like a more complete option.

We will use a small program as an example to show you how could it be tested using both options which in the end will help us to get a better picture of how the two of them compare.

The example demonstrating testing tools is a simplified version of a version control tool that supports code reviews in merge requests. We will start with the following criteria:

- A merge request is `rejected` if at least one person disagrees with the changes
- If nobody has disagreed, and the merge request is good for at least two other developers, it's `approved`
- In any other case, its status is `pending`

And here is what the code might look like:

```
from enum import Enum

class MergeRequestStatus(Enum):
    APPROVED = "approved"
    REJECTED = "rejected"
    PENDING = "pending"

class MergeRequest:
    def __init__(self):
        self._context = {
            "upvotes": set(),
            "downvotes": set(),
        }

    @property
    def status(self):
        if self._context["downvotes"]:
            return MergeRequestStatus.REJECTED
        elif len(self._context["upvotes"]) >= 2:
            return MergeRequestStatus.APPROVED
        return MergeRequestStatus.PENDING

    def upvote(self, by_user):
        self._context["downvotes"].discard(by_user)
        self._context["upvotes"].add(by_user)

    def downvote(self, by_user):
        self._context["upvotes"].discard(by_user)
        self._context["downvotes"].add(by_user)
```

unittest

The `unittest` module is a great option with which to start writing unit tests because it provides a rich API to write all kinds of testing conditions, and since it's available in the standard library, it's quite versatile and convenient.

The `unittest` module is based on the concepts of JUnit (from Java), which in turn is also based on the original ideas of unit testing that come from Smalltalk, so it's object-oriented in nature. For this reason, tests are written through objects, where the checks are verified by methods, and it's common to group tests by scenarios in classes.

To start writing unit tests, we have to create a test class that inherits from `unittest.TestCase`, and define the conditions we want to stress on its methods. These methods should start with `test_*`, and can internally use any of the methods inherited from `unittest.TestCase` to check conditions that must hold true.

Some examples of conditions we might want to verify for our case are as follows:

```
class TestMergeRequestStatus(unittest.TestCase):

    def test_simple_rejected(self):
        merge_request = MergeRequest()
        merge_request.downvote("maintainer")
        self.assertEqual(merge_request.status, MergeRequestStatus.REJECTED)

    def test_just_created_is_pending(self):
        self.assertEqual(MergeRequest().status, MergeRequestStatus.PENDING)

    def test_pending_awaiting_review(self):
        merge_request = MergeRequest()
        merge_request.upvote("core-dev")
        self.assertEqual(merge_request.status, MergeRequestStatus.PENDING)

    def test_approved(self):
        merge_request = MergeRequest()
        merge_request.upvote("dev1")
        merge_request.upvote("dev2")

        self.assertEqual(merge_request.status, MergeRequestStatus.APPROVED)
```

The API for unit testing provides many useful methods for comparison, the most common one being `assertEquals(<actual>, <expected>[, message])`, which can be used to compare the result of the operation against the value we were expecting, optionally using a message that will be shown in the case of an error.

Another useful testing method allows us to check whether a certain exception was raised or not. When something exceptional happens, we raise an exception in our code to prevent continuous processing under the wrong assumptions, and also to inform the caller that something is wrong with the call as it was performed. This is the part of the logic that ought to be tested, and that's what this method is for.

Imagine that we are now extending our logic a little bit further to allow users to close their merge requests, and once this happens, we don't want any more votes to take place (it wouldn't make sense to evaluate a merge request once this was already closed). To prevent this from happening, we extend our code and we raise an exception on the unfortunate event when someone tries to cast a vote on a closed merge request.

After adding two new statuses (`OPEN` and `CLOSED`), and a new `close()` method, we modify the previous methods for the voting to handle this check first:

```
class MergeRequest:
    def __init__(self):
        self._context = {
            "upvotes": set(),
            "downvotes": set(),
        }
        self._status = MergeRequestStatus.OPEN

    def close(self):
        self._status = MergeRequestStatus.CLOSED

    ...
    def _cannot_vote_if_closed(self):
        if self._status == MergeRequestStatus.CLOSED:
            raise MergeRequestException("can't vote on a closed merge
                request")

    def upvote(self, by_user):
        self._cannot_vote_if_closed()

        self._context["downvotes"].discard(by_user)
        self._context["upvotes"].add(by_user)

    def downvote(self, by_user):
        self._cannot_vote_if_closed()

        self._context["upvotes"].discard(by_user)
        self._context["downvotes"].add(by_user)
```

Now, we want to check that this validation indeed works. For this, we're going to use the `assertRaises` and `assertRaisesRegex` methods:

```
def test_cannot_upvote_on_closed_merge_request(self):
    self.merge_request.close()
    self.assertRaises(
        MergeRequestException, self.merge_request.upvote, "dev1"
    )

def test_cannot_downvote_on_closed_merge_request(self):
    self.merge_request.close()
    self.assertRaisesRegex(
        MergeRequestException,
        "can't vote on a closed merge request",
        self.merge_request.downvote,
        "dev1",
    )
```

The former will expect that the provided exception is raised when calling the callable in the second argument, with the arguments (`*args` and `**kwargs`) on the rest of the function, and if that's not the case it will fail, saying that the exception that was expected to be raised, wasn't. The latter does the same but it also checks that the exception that was raised, contains the message matching the regular expression that was provided as a parameter. Even if the exception is raised, but with a different message (not matching the regular expression), the test will fail.



Try to check for the error message, as not only will the exception, as an extra check, be more accurate and ensure that it is actually the exception we want that is being triggered, it will check whether another one of the same types got there by chance.

Parametrized tests

Now, we would like to test how the threshold acceptance for the merge request works, just by providing data samples of what the `context` looks like without needing the entire `MergeRequest` object. We want to test the part of the `status` property that is after the line that checks if it's closed, but independently.

The best way to achieve this is to separate that component into another class, use composition, and then move on to test this new abstraction with its own test suite:

```
class AcceptanceThreshold:
    def __init__(self, merge_request_context: dict) -> None:
        self._context = merge_request_context
```

```
def status(self):
    if self._context["downvotes"]:
        return MergeRequestStatus.REJECTED
    elif len(self._context["upvotes"]) >= 2:
        return MergeRequestStatus.APPROVED
    return MergeRequestStatus.PENDING

class MergeRequest:
    ...
    @property
    def status(self):
        if self._status == MergeRequestStatus.CLOSED:
            return self._status

        return AcceptanceThreshold(self._context).status()
```

With these changes, we can run the tests again and verify that they pass, meaning that this small refactor didn't break anything of the current functionality (unit tests ensure regression). With this, we can proceed with our goal to write tests that are specific to the new class:

```
class TestAcceptanceThreshold(unittest.TestCase):
    def setUp(self):
        self.fixture_data = (
            (
                {"downvotes": set(), "upvotes": set()},
                MergeRequestStatus.PENDING
            ),
            (
                {"downvotes": set(), "upvotes": {"dev1"}},
                MergeRequestStatus.PENDING,
            ),
            (
                {"downvotes": "dev1", "upvotes": set()},
                MergeRequestStatus.REJECTED
            ),
            (
                {"downvotes": set(), "upvotes": {"dev1", "dev2"}},
                MergeRequestStatus.APPROVED
            ),
        )

    def test_status_resolution(self):
        for context, expected in self.fixture_data:
            with self.subTest(context=context):
                status = AcceptanceThreshold(context).status()
                self.assertEqual(status, expected)
```

Here, in the `setUp()` method, we define the data fixture to be used throughout the tests. In this case, it's not actually needed, because we could have put it directly on the method, but if we expect to run some code before any test is executed, this is the place to write it, because this method is called once before every test is run.

By writing this new version of the code, the parameters under the code being tested are clearer and more compact, and at each case, it will report the results.

To simulate that we're running all of the parameters, the test iterates over all the data, and exercises the code with each instance. One interesting helper here is the use of `subTest`, which in this case we use to mark the test condition being called. If one of these iterations failed, `unittest` would report it with the corresponding value of the variables that were passed to the `subTest` (in this case, it was named `context`, but any series of keyword arguments would work just the same). For example, one error occurrence might look like this:

```
FAIL: (context={'downvotes': set(), 'upvotes': {'dev1', 'dev2'}})
-----
Traceback (most recent call last):
  File "test_status_resolution
    self.assertEqual(status, expected)
AssertionError: <MergeRequestStatus.APPROVED: 'approved'> !=
<MergeRequestStatus.REJECTED: 'rejected'>
```



If you choose to parameterize tests, try to provide the context of each instance of the parameters with as much information as possible to make debugging easier.

pytest

Pytest is a great testing framework, and can be installed via `pip install pytest`. A difference with respect to `unittest` is that, while it's still possible to classify test scenarios in classes and create object-oriented models of our tests, this is not actually mandatory, and it's possible to write unit tests with less boilerplate by just checking the conditions we want to verify with the `assert` statement.

By default, making comparisons with an `assert` statement will be enough for `pytest` to identify a unit test and report its result accordingly. More advanced uses such as those seen in the previous section are also possible, but they require using specific functions from the package.

A nice feature is that the command `pytest` will run all the tests that it can discover, even if they were written with `unittest`. This compatibility makes it easier to transition from `unittest` toward `pytest` gradually.

Basic test cases with `pytest`

The conditions we tested in the previous section can be rewritten in simple functions with `pytest`.

Some examples with simple assertions are as follows:

```
def test_simple_rejected():
    merge_request = MergeRequest()
    merge_request.downvote("maintainer")
    assert merge_request.status == MergeRequestStatus.REJECTED

def test_just_created_is_pending():
    assert MergeRequest().status == MergeRequestStatus.PENDING

def test_pending_awaiting_review():
    merge_request = MergeRequest()
    merge_request.upvote("core-dev")
    assert merge_request.status == MergeRequestStatus.PENDING
```

Boolean equality comparisons don't require more than a simple `assert` statement, whereas other kinds of checks like the ones for the exceptions do require that we use some functions:

```
def test_invalid_types():
    merge_request = MergeRequest()
    pytest.raises(TypeError, merge_request.upvote, {"invalid-object"})

def test_cannot_vote_on_closed_merge_request():
    merge_request = MergeRequest()
    merge_request.close()
    pytest.raises(MergeRequestException, merge_request.upvote, "dev1")
    with pytest.raises(
        MergeRequestException,
        match="can't vote on a closed merge request",
    ):
        merge_request.downvote("dev1")
```

In this case, `pytest.raises` is the equivalent of `unittest.TestCase.assertRaises`, and it also accepts that it be called both as a method and as a context manager. If we want to check the message of the exception, instead of a different method (like `assertRaisesRegex`), the same function has to be used, but as a context manager, and by providing the `match` parameter with the expression we would like to identify.

`pytest` will also wrap the original exception into a custom one that can be expected (by checking some of its attributes such as `.value`, for instance) in case we want to check for more conditions, but this use of the function covers the vast majority of cases.

Parametrized tests

Running parametrized tests with `pytest` is better, not only because it provides a cleaner API, but also because each combination of the test with its parameters generates a new test case.

To work with this, we have to use the `pytest.mark.parametrize` decorator on our test. The first parameter of the decorator is a string indicating the names of the parameters to pass to the `test` function, and the second has to be iterable with the respective values for those parameters.

Notice how the body of the testing function is reduced to one line (after removing the internal `for` loop, and its nested context manager), and the data for each test case is correctly isolated from the body of the function, making it easier to extend and maintain:

```
@pytest.mark.parametrize("context, expected_status", (
    (
        {"downvotes": set(), "upvotes": set()},
        MergeRequestStatus.PENDING
    ),
    (
        {"downvotes": set(), "upvotes": {"dev1"}},
        MergeRequestStatus.PENDING,
    ),
    (
        {"downvotes": "dev1", "upvotes": set()},
        MergeRequestStatus.REJECTED
    ),
    (
        {"downvotes": set(), "upvotes": {"dev1", "dev2"}},
        MergeRequestStatus.APPROVED
    ),
))
def test_acceptance_threshold_status_resolution(context, expected_status):
    assert AcceptanceThreshold(context).status() == expected_status
```



Use `@pytest.mark.parametrize` to eliminate repetition, keep the body of the test as cohesive as possible, and make the parameters (test inputs or scenarios) that the code must support explicitly.

Fixtures

One of the great things about `pytest` is how it facilitates creating reusable features so that we can feed our tests with data or objects in order to test more effectively and without repetition.

For example, we might want to create a `MergeRequest` object in a particular state, and use that object in multiple tests. We define our object as a fixture by creating a function and applying the `@pytest.fixture` decorator. The tests that want to use that fixture will have to have a parameter with the same name as the function that's defined, and `pytest` will make sure that it's provided:

```
@pytest.fixture
def rejected_mr():
    merge_request = MergeRequest()

    merge_request.downvote("dev1")
    merge_request.upvote("dev2")
    merge_request.upvote("dev3")
    merge_request.downvote("dev4")

    return merge_request

def test_simple_rejected(rejected_mr):
    assert rejected_mr.status == MergeRequestStatus.REJECTED

def test_rejected_with_approvals(rejected_mr):
    rejected_mr.upvote("dev2")
    rejected_mr.upvote("dev3")
    assert rejected_mr.status == MergeRequestStatus.REJECTED

def test_rejected_to_pending(rejected_mr):
    rejected_mr.upvote("dev1")
    assert rejected_mr.status == MergeRequestStatus.PENDING

def test_rejected_to_approved(rejected_mr):
    rejected_mr.upvote("dev1")
    rejected_mr.upvote("dev2")
    assert rejected_mr.status == MergeRequestStatus.APPROVED
```

Remember that tests affect the main code as well, so the principles of clean code apply to them as well. In this case, the **Don't Repeat Yourself (DRY)** principle that we explored in previous chapters appears once again, and we can achieve it with the help of `pytest` fixtures.

Besides creating multiple objects or exposing data that will be used throughout the test suite, it's also possible to use them to set up some conditions, for example, to globally patch some functions that we don't want to be called, or when we want patch objects to be used instead.

Code coverage

Tests runners support coverage plugins (to be installed via `pip`) that will provide useful information about what lines in the code have been executed while the tests were running. This information is of great help so that we know which parts of the code need to be covered by tests, as well identifying improvements to be made (both in the production code and in the tests). One of the most widely used libraries for this is `coverage` (<https://pypi.org/project/coverage/>).

While they are of great help (and we highly recommend that you use them and configure your project to run coverage in the CI when tests are run), they can also be misleading; particularly in Python, we can get a false impression if we don't pay close attention to the coverage report.

Setting up rest coverage

In the case of `pytest`, we have to install the `pytest-cov` package (at the time of this writing, version 2.5.1 is used in this book). Once installed, when the tests are run, we have to tell the `pytest` runner that `pytest-cov` will also run, and which package (or packages) should be covered (among other parameters and configurations).

This package supports multiple configurations, like different sorts of output formats, and it's easy to integrate it with any CI tool, but among all these features a highly recommended option is to set the flag that will tell us which lines haven't been covered by tests yet, because this is what's going to help us diagnose our code and allow us to start writing more tests.

To show you an example of what this would look like, use the following command:

```
pytest \
  --cov-report term-missing \
  --cov=coverage_1 \
  test_coverage_1.py
```

This will produce an output similar to the following:

```
test_coverage_1.py ..... [100%]

----- coverage: platform linux, python 3.6.5-final-0 -----
Name          Stmt% Miss Cover Missing
-----
coverage_1.py 38      1  97%   53
```

Here, it's telling us that there is a line that doesn't have unit tests so that we can take a look and see how to write a unit test for it. This is a common scenario where we realize that to cover those missing lines, we need to refactor the code by creating smaller methods. As a result, our code will look much better, as in the example we saw at the beginning of this chapter.

The problem lies in the inverse situation—can we trust the high coverage? Does it mean our code is correct? Unfortunately, having good test coverage is necessary but in sufficient condition for clean code. Not having tests for parts of the code is clearly something bad. Having tests is actually very good (and we can say this for the tests that do exist), and actually asserts real conditions that they are a guarantee of quality for that part of the code. However, we cannot say that is all that is required; despite having a high level of coverage, even more tests are required.

These are the caveats of test coverage, which we will mention in the next section.

Caveats of test coverage

Python is interpreted and, at a very high-level, coverage tools take advantage of this to identify the lines that were interpreted (run) while the tests were running. It will then report this at the end. The fact that a line was interpreted does not mean that it was properly tested, and this is why we should be careful about reading the final coverage report and trusting what it says.

This is actually true for any language. The fact that a line was exercised does not mean at all that it was stressed with all its possible combinations. The fact that all branches run successfully with the provided data only means that the code supported that combination, but it doesn't tell us anything about any other possible combinations of parameters that would make the program crash.



Use coverage as a tool to find blind spots in the code, but not as a metric or target goal.

Mock objects

There are cases where our code is not the only thing that will be present in the context of our tests. After all, the systems we design and build have to do something real, and that usually means connecting to external services (databases, storage services, external APIs, cloud services, and so on). Because they need to have those side-effects, they're inevitable. As much as we abstract our code, program towards interfaces, and isolate code from external factors in order to minimize side-effects, they will be present in our tests, and we need an effective way to handle that.

Mock objects are one of the best tactics to defend against undesired side-effects. Our code might need to perform an HTTP request or send a notification email, but we surely don't want that to happen in our unit tests. Besides, unit tests should run quickly, as we want to run them quite often (all the time, actually), and this means we cannot afford latency. Therefore, real unit tests don't use any actual service—they don't connect to any database, they don't issue HTTP requests, and basically, they do nothing other than exercise the logic of the production code.

We need tests that do such things, but they aren't units. Integration tests are supposed to test functionality with a broader perspective, almost mimicking the behavior of a user. But they aren't fast. Because they connect to external systems and services, they take longer to run and are more expensive. In general, we would like to have lots of unit tests that run really quickly in order to run them all the time, and have integration tests run less often (for instance, on any new merge request).

While mock objects are useful, abusing their use ranges between a code smell or an anti-pattern is the first caveat we would like to mention before going into the details of it.

A fair warning about patching and mocks

We said before that unit tests help us write better code, because the moment we want to start testing parts of the code, we usually have to write them to be testable, which often means they are also cohesive, granular, and small. These are all good traits to have in a software component.

Another interesting gain is that testing will help us notice code smells in parts where we thought our code was correct. One of the main warnings that our code has code smells is whether we find ourselves trying to monkey-patch (or mock) a lot of different things just to cover a simple test case.

The `unittest` module provides a tool for patching our objects at `unittest.mock.patch`. Patching means that the original code (given by a string denoting its location at import time), will be replaced by something else, other than its original code, being the default a mock object. This replaces the code at run-time, and has the disadvantage that we are losing contact with the original code that was there in the first place, making our tests a little more shallow. It also carries performance considerations, because of the overhead that imposes modifying objects in the interpreter at run-time, and it's something that might end up update if we refactor our code and move things around.

Using monkey-patching or mocks in our tests might be acceptable, and by itself it doesn't represent an issue. On the other hand, abuse in monkey-patching is indeed a flag that something has to be improved in our code.

Using mock objects

In unit testing terminology, there are several types of object that fall into the category named **test doubles**. A test double is a type of object that will take the place of a real one in our test suite for different kinds of reasons (maybe we don't need the actual production code, but just a dummy object would work, or maybe we can't use it because it requires access to services or it has side-effects that we don't want in our unit tests, and so on).

There are different types of test double, such as dummy objects, stubs, spies, or mocks. Mocks are the most general type of object, and since they're quite flexible and versatile, they are appropriate for all cases without needing to go into much detail about the rest of them. It is for this reason that the standard library also includes an object of this kind, and it is common in most Python programs. That's the one we are going to be using here: `unittest.mock.Mock`.

A **mock** is a type of object created to a specification (usually resembling the object of a production class) and some configured responses (that is, we can tell the mock what it should return upon certain calls, and what its behavior should be). The `Mock` object will then record, as part of its internal status, how it was called (with what parameters, how many times, and so on), and we can use that information to verify the behavior of our application at a later stage.

In the case of Python, the `Mock` object that's available from the standard library provides a nice API to make all sorts of behavioral assertions, such as checking how many times the mock was called, with what parameters, and so on.

Types of mocks

The standard library provides `Mock` and `MagicMock` objects in the `unittest.mock` module. The former is a test double that can be configured to return any value and will keep track of the calls that were made to it. The latter does the same, but it also supports magic methods. This means that, if we have written idiomatic code that uses magic methods (and parts of the code we are testing will rely on that), it's likely that we will have to use a `MagicMock` instance instead of just a `Mock`.

Trying to use `Mock` when our code needs to call magic methods will result in an error. See the following code for an example of this:

```
class GitBranch:
    def __init__(self, commits: List[Dict]):
        self._commits = {c["id"]: c for c in commits}

    def __getitem__(self, commit_id):
        return self._commits[commit_id]

    def __len__(self):
        return len(self._commits)

def author_by_id(commit_id, branch):
    return branch[commit_id]["author"]
```

We want to test this function; however, another test needs to call the `author_by_id` function. For some reason, since we're not testing that function, any value provided to that function (and returned) will be good:

```
def test_find_commit():
    branch = GitBranch([{"id": "123", "author": "dev1"}])
    assert author_by_id("123", branch) == "dev1"

def test_find_any():
    author = author_by_id("123", Mock()) is not None
    # ... rest of the tests..
```

As anticipated, this will not work:

```
def author_by_id(commit_id, branch):
    > return branch[commit_id]["author"]
E TypeError: 'Mock' object is not subscriptable
```

Using `MagicMock` instead will work. We can even configure the magic method of this type of mock to return something we need in order to control the execution of our test:

```
def test_find_any():
    mbranch = MagicMock()
    mbranch.__getitem__.return_value = {"author": "test"}
    assert author_by_id("123", mbranch) == "test"
```

A use case for test doubles

To see a possible use of mocks, we need to add a new component to our application that will be in charge of notifying the merge request of the status of the build. When a build is finished, this object will be called with the ID of the merge request and the status of the build, and it will update the status of the merge request with this information by sending an HTTP POST request to a particular fixed endpoint:

```
# mock_2.py

from datetime import datetime

import requests
from constants import STATUS_ENDPOINT

class BuildStatus:
    """The CI status of a pull request."""
```

```
@staticmethod
def build_date() -> str:
    return datetime.utcnow().isoformat()

@classmethod
def notify(cls, merge_request_id, status):
    build_status = {
        "id": merge_request_id,
        "status": status,
        "built_at": cls.build_date(),
    }
    response = requests.post(STATUS_ENDPOINT, json=build_status)
    response.raise_for_status()
    return response
```

This class has many side-effects, but one of them is an important external dependency which is hard to surmount. If we try to write a test over it without modifying anything, it will fail with a connection error as soon as it tries to perform the HTTP connection.

As a testing goal, we just want to make sure that the information is composed correctly, and that library requests are being called with the appropriate parameters. Since this is an external dependency, we don't test requests; just checking that it's called correctly will be enough.

Another problem we will face when trying to compare data being sent to the library is that the class is calculating the current timestamp, which is impossible to predict in a unit test. Patching `datetime` directly is not possible, because the module is written in C. There are some external libraries that can do that (`freezegun`, for example), but they come with a performance penalty, and for this example would be overkill. Therefore, we opt to wrapping the functionality we want in a static method that we will be able to patch.

Now that we have established the points that need to be replaced in the code, let's write the unit test:

```
# test_mock_2.py

from unittest import mock

from constants import STATUS_ENDPOINT
from mock_2 import BuildStatus

@mock.patch("mock_2.requests")
def test_build_notification_sent(mock_requests):
    build_date = "2018-01-01T00:00:01"
    with mock.patch("mock_2.BuildStatus.build_date",
```



```
return_value=build_date):
    BuildStatus.notify(123, "OK")

expected_payload = {"id": 123, "status": "OK", "built_at":
build_date}
mock_requests.post.assert_called_with(
    STATUS_ENDPOINT, json=expected_payload
)
```

First, we use `mock.patch` as a decorator to replace the `requests` module. The result of this function will create a `mock` object that will be passed as a parameter to the test (named `mock_requests` in this example). Then, we use this function again, but this time as a context manager to change the return value of the method of the class that computes the date of the `build`, replacing the value with one we control, that we will use in the assertion.

Once we have all of this in place, we can call the class method with some parameters, and then we can use the `mock` object to check how it was called. In this case, we are using the method to see if `requests.post` was indeed called with the parameters as we wanted them to be composed.

This is a nice feature of mocks—not only do they put some boundaries around all external components (in this case to prevent actually sending some notifications or issuing HTTP requests), but they also provide a useful API to verify the calls and their parameters.

While, in this case, we were able to test the code by setting the respective `mock` objects in place, it's also true that we had to patch quite a lot in proportion to the total lines of code for the main functionality. There is no rule about the ratio of pure productive code being tested versus how many parts of that code we have to mock, but certainly, by using common sense, we can see that, if we had to patch quite a lot of things in the same parts, something is not clearly abstracted, and it looks like a code smell.

In the next section, we will explore how to refactor code to overcome this issue.

Refactoring

Refactoring is a critical activity in software maintenance, yet something that can't be done (at least correctly) without having unit tests. Every now and then, we need to support a new feature or use our software in unintended ways. We need to realize that the only way to accommodate such requirements is by first refactoring our code, make it more generic. Only then can we move forward.

Typically, when refactoring our code, we want to improve its structure and make it better, sometimes more generic, more readable, or more flexible. The challenge is to achieve these goals while at the same time preserving the exact same functionality it had prior to the modifications that were made. This means that, in the eyes of the clients of those components we're refactoring, it might as well be the case that nothing had happened at all.

This constraint of having to support the same functionalities as before but with a different version of the code implies that we need to run regression tests on code that was modified. The only cost-effective way of running regression tests is if those tests are automatic. The most cost-effective version of automatic tests is unit tests.

Evolving our code

In the previous example, we were able to separate out the side-effects from our code to make it testable by patching those parts of the code that depended on things we couldn't control on the unit test. This is a good approach since, after all, the `mock.patch` function comes in handy for these sorts of task and replaces the objects we tell it to, giving us back a `Mock` object.

The downside of that is that we have to provide the path of the object we are going to mock, including the module, as a string. This is a bit fragile, because if we refactor our code (let's say we rename the file or move it to some other location), all the places with the patch will have to be updated, or the test will break.

In the example, the fact that the `notify()` method directly depends on an implementation detail (the `requests` module) is a design issue, that is, it is taking its toll on the unit tests as well with the aforementioned fragility that is implied.

We still need to replace those methods with doubles (mocks), but if we refactor the code, we can do it in a better way. Let's separate these methods into smaller ones, and most importantly inject the dependency rather than keep it fixed. The code now applies the dependency inversion principle, and it expects to work with something that supports an interface (in this example, implicit one) such as the one the `requests` module provides:

```
from datetime import datetime

from constants import STATUS_ENDPOINT

class BuildStatus:

    endpoint = STATUS_ENDPOINT
```

```
def __init__(self, transport):
    self.transport = transport

    @staticmethod
    def build_date() -> str:
        return datetime.utcnow().isoformat()

    def compose_payload(self, merge_request_id, status) -> dict:
        return {
            "id": merge_request_id,
            "status": status,
            "built_at": self.build_date(),
        }

    def deliver(self, payload):
        response = self.transport.post(self.endpoint, json=payload)
        response.raise_for_status()
        return response

    def notify(self, merge_request_id, status):
        return self.deliver(self.compose_payload(merge_request_id, status))
```

We separate the methods (not notify is now compose + deliver), make `compose_payload()` a new method (so that we can replace, without the need to patch the class), and require the `transport` dependency to be injected. Now that `transport` is a dependency, it is much easier to change that object for any double we want.

It is even possible to expose a fixture of this object with the doubles replaced as required:

```
@pytest.fixture
def build_status():
    bstatus = BuildStatus(Mock())
    bstatus.build_date = Mock(return_value="2018-01-01T00:00:01")
    return bstatus

def test_build_notification_sent(build_status):

    build_status.notify(1234, "OK")

    expected_payload = {
        "id": 1234,
        "status": "OK",
        "built_at": build_status.build_date(),
    }
```

```
build_status.transport.post.assert_called_with(  
    build_status.endpoint, json=expected_payload  
)
```

Production code isn't the only thing that evolves

We keep saying that unit tests are as important as production code. And if we are careful enough with production code as to create the best possible abstraction, why wouldn't we do the same for unit tests?

If the code for unit tests is as important as the main code, then it's definitely wise to design it with extensibility in mind and make it as maintainable as possible. After all, this is the code that will have to be maintained by an engineer other than its original author, so it has to be readable.

The reason why we pay so much attention to make the code's flexibility is that we know requirements change and evolve over time, and eventually as domain business rules change, our code will have to change as well to support these new requirements. Since the production code changed to support new requirements, in turn, the testing code will have to change as well to support the newer version of the production code.

In one of the first examples we used, we created a series of tests for the merge request object, trying different combinations and checking the status at which the merge request was left. This is a good first approach, but we can do better than that.

Once we understand the problem better, we can start creating better abstractions. With this, the first idea that comes to mind is that we can create a higher-level abstraction that checks for particular conditions. For example, if we have an object that is a test suite that specifically targets the `MergeRequest` class, we know its functionality will be limited to the behavior of this class (because it should comply to the SRP), and therefore we could create specific testing methods on this testing class. These will only make sense for this class, but that will be helpful in reducing a lot of boilerplate code.

Instead of repeating assertions that follow the exact same structure, we can create a method that encapsulates this and reuse it across all of the tests:

```
class TestMergeRequestStatus(unittest.TestCase):
    def setUp(self):
        self.merge_request = MergeRequest()

    def assert_rejected(self):
        self.assertEqual(
            self.merge_request.status, MergeRequestStatus.REJECTED
        )

    def assert_pending(self):
        self.assertEqual(
            self.merge_request.status, MergeRequestStatus.PENDING
        )

    def assert_approved(self):
        self.assertEqual(
            self.merge_request.status, MergeRequestStatus.APPROVED
        )

    def test_simple_rejected(self):
        self.merge_request.downvote("maintainer")
        self.assert_rejected()

    def test_just_created_is_pending(self):
        self.assert_pending()
```

If something changes with how we check the status of a merge request (or let's say we want to add extra checks), there is only one place (the `assert_approved()` method) that will have to be modified. More importantly, by creating these higher-level abstractions, the code that started as merely unit tests starts to evolve into what could end up being a testing framework with its own API or domain language, making testing more declarative.

More about unit testing

With the concepts we have revisited so far, we know how to test our code, think about our design in terms of how it is going to be tested, and configure the tools in our project to run the automated tests that will give us some degree of confidence over the quality of the software we have written.

If our confidence in the code is determined by the unit tests written on it, how do we know that they are enough? How could we be sure that we have been thorough enough on the test scenarios and that we are not missing some tests? Who says that these tests are correct? Meaning, who tests the tests?

The first part of the question, about being thorough on the tests we wrote, is answered by going beyond in our testing efforts through property-based testing.

The second part of the question might have multiple answers from different points of view, but we are going to briefly mention mutation testing as a means of determining that our tests are indeed correct. In this sense, we are thinking that the unit tests check our main productive code, and this works as a control for the unit tests as well.

Property-based testing

Property-based testing consists of generating data for tests cases with the goal of finding scenarios that will make the code fail, which weren't covered by our previous unit tests.

The main library for this is `hypothesis` which, configured along with our unit tests, will help us find problematic data that will make our code fail.

We can imagine that what this library does is find counter examples for our code. We write our production code (and unit tests for it!), and we claim it's correct. Now, with this library, we define some `hypothesis` that must hold for our code, and if there are some cases where our assertions don't hold, the `hypothesis` will provide a set of data that causes the error.

The best thing about unit tests is that they make us think harder about our production code. The best thing about the `hypothesis` is that it makes us think harder about our unit tests.

Mutation testing

We know that tests are the formal verification method we have to ensure that our code is correct. And what makes sure that the test is correct? The production code, you might think, and yes, in a way this is correct, we can think of the main code as a counter balance for our tests.

The point in writing unit tests is that we are protecting ourselves against bugs, and testing for failure scenarios we really don't want to happen in production. It's good that the tests pass, but it would be bad if they pass for the wrong reasons. That is, we can use unit tests as an automatic regression tool—if someone introduces a bug in the code, later on, we expect at least one of our tests to catch it and fail. If this doesn't happen, either there is a test missing, or the ones we had are not doing the right checks.

This is the idea behind mutation testing. With a mutation testing tool, the code will be modified to new versions (called mutants), that are variations of the original code but with some of its logic altered (for example, operators are swapped, conditions are inverted, and so on). A good test suite should catch these mutants and kill them, in which case it means we can rely on the tests. If some mutants survive the experiment, it's usually a bad sign. Of course, this is not entirely precise, so there are intermediate states we might want to ignore.

To quickly show you how this works and to allow you to get a practical idea of this, we are going to use a different version of the code that computes the status of a merge request based on the number of approvals and rejections. This time, we have changed the code for a simple version that, based on these numbers, returns the result. We have moved the enumeration with the constants for the statuses to a separate module so that it now looks more compact:

```
# File mutation_testing_1.py
from mrstatus import MergeRequestStatus as Status

def evaluate_merge_request(upvote_count, downvotes_count):
    if downvotes_count > 0:
        return Status.REJECTED
    if upvote_count >= 2:
        return Status.APPROVED
    return Status.PENDING
```

And now will we add a simple unit test, checking one of the conditions and its expected result:

```
# file: test_mutation_testing_1.py
class TestMergeRequestEvaluation(unittest.TestCase):
    def test_approved(self):
        result = evaluate_merge_request(3, 0)
        self.assertEqual(result, Status.APPROVED)
```

Now, we will install `mutpy`, a mutation testing tool for Python, with `pip install mutpy`, and tell it to run the mutation testing for this module with these tests:

```
$ mut.py \
  --target mutation_testing_1N \
```

```

--unit-test test_mutation_testing_$N \
--operator AOD `# delete arithmetic operator` \
--operator AOR `# replace arithmetic operator` \
--operator COD `# delete conditional operator` \
--operator COI `# insert conditional operator` \
--operator CRP `# replace constant` \
--operator ROR `# replace relational operator` \
--show-mutants

```

The result is going to look something similar to this:

```

[*] Mutation score [0.04649 s]: 100.0%
- all: 4
- killed: 4 (100.0%)
- survived: 0 (0.0%)
- incompetent: 0 (0.0%)
- timeout: 0 (0.0%)

```

This is a good sign. Let's take a particular instance to analyze what happened. One of the lines on the output shows the following mutant:

```

- [# 1] ROR mutation_testing_1:11 :
-----
  7: from mrstatus import MergeRequestStatus as Status
  8:
  9:
 10: def evaluate_merge_request(upvote_count, downvotes_count):
~11:     if downvotes_count < 0:
 12:         return Status.REJECTED
 13:     if upvote_count >= 2:
 14:         return Status.APPROVED
 15:     return Status.PENDING
-----
[0.00401 s] killed by test_approved
(test_mutation_testing_1.TestMergeRequestEvaluation)

```

Notice that this mutant consists of the original version with the operator changed in line 11 (> for <), and the result is telling us that this mutant was killed by the tests. This means that with this version of the code (let's imagine that someone by mistakes makes this change), then the result of the function would have been `APPROVED`, and since the test expects it to be `REJECTED`, it fails, which is a good sign (the test caught the bug that was introduced).

Mutation testing is a good way to assure the quality of the unit tests, but it requires some effort and careful analysis. By using this tool in complex environments, we will have to take some time analyzing each scenario. It is also true that it is expensive to run these tests because it requires multiples runs of different versions of the code, which might take up too many resources and may take longer to complete. However, it would be even more expensive to have to make these checks manually and will require much more effort. Not doing these checks at all might be even riskier, because we would be jeopardizing the quality of the tests.

A brief introduction to test-driven development

There are entire books dedicated only to TDD, so it would not be realistic to try and cover this topic comprehensively in this book. However, it's such an important topic that it has to be mentioned.

The idea behind TDD is that tests should be written before production code in a way that the production code is only written to respond to tests that are failing due to that missing implementation of the functionality.

There are multiple reasons why we would like to write the tests first and then the code. From a pragmatic point of view, we would be covering our production code quite accurately. Since all of the production code was written to respond to a unit test, it would be highly unlikely that there are tests missing for functionality (that doesn't mean that there is 100% of coverage of course, but at least all main functions, methods, or components will have their respective tests, even if they aren't completely covered).

The workflow is simple and at a high-level consist of three steps. First, we write a unit test that describes something we need to be implemented. When we run this test, it will fail, because that functionality has not been implemented yet. Then, we move onto implementing the minimal required code that satisfies that condition, and we run the test again. This time, the test should pass. Now, we can improve (refactor) the code.

This cycle has been popularized as the famous **red-green-refactor**, meaning that in the beginning, the tests fail (red), then we make them pass (green), and then we proceed to refactor the code and iterate it.

Summary

Unit testing is a really interesting and deep topic, but more importantly, it is a critical part of the clean code. Ultimately, unit tests are what determine the quality of the code. Unit tests often act as a mirror for the code—when the code is easy to test, it's clear and correctly designed, and this will be reflected in the unit tests.

The code for the unit tests is as important as production code. All principles that apply to production code also apply to unit tests. This means that they should be designed and maintained with the same effort and thoughtfulness. If we don't care about our unit tests, they will start to have problems and become defective (or problematic), and as a result of that, useless. If this happens, and they are hard to maintain, they become a liability which makes things even worse, because people will tend to ignore them or disable them entirely. This is the worst scenario because once this happens, the entire production code is in jeopardy. Moving forward blindly (without unit tests) is a recipe for disaster.

Luckily, Python provides many tools for unit testing, both in the standard library and available through `pip`. They are of great help, and investing a time in configuring them really pays off in the long run.

We have seen how unit tests work as the formal specification of the program, and the proof that a piece of software works according to the specification, and we also learned that when it comes to discovering new testing scenarios, there is always room for improvement, and that we can always create more tests. In this sense, expanding our unit tests with different approaches (like property-based testing or mutation testing) is a good investment.

References

Here is a list of information you can refer to:

- The `unittest` module of the Python standard library contains comprehensive documentation on how to start building a test suite (<https://docs.python.org/3/library/unittest.html>)
- Hypothesis official documentation (<https://hypothesis.readthedocs.io/en/latest/>)
- `pytest` official documentation (<https://docs.pytest.org/en/latest/>)
- *The Cathedral and the Bazaar: Musings on Linux and Open Source by an Accidental Revolutionary (CatB)*, written by Eric S. Raymond (publisher O'Reilly Media, 1999)

9 Common Design Patterns

Design patterns have been a widespread topic in software engineering since their original inception in the famous **Gang of Four (GoF)** book, *Design Patterns: Elements of Reusable Object-Oriented Software*. Design patterns help to solve common problems with abstractions that work for certain scenarios. When they are implemented properly, the general design of the solution can benefit from them.

In this chapter we take a look at some of the most common design patterns, but not from the perspective of tools to apply under certain conditions (once the patterns have been devised), but rather we analyze how design patterns contribute to clean code. After presenting a solution that implements a design pattern, we analyze how the final implementation is comparatively better as if we had chosen a different path.

As part of this analysis, we will see how to concretely implement design patterns in Python. As a result of that, we will see that the dynamic nature of Python implies some differences of implementation, with respect to other static typed languages, for which many of the design patterns were originally thought of. This means that there are some particularities about design patterns that you should bear in mind when it comes to Python, and, in some cases, trying to apply a design pattern where it doesn't really fit is non-Pythonic.

In this chapter, we will cover the following topics:

- Common design patterns.
- Design patterns that don't apply in Python, and the idiomatic alternative that should be followed.
- The Pythonic way of implementing the most common design patterns.
- Understanding how good abstractions evolve naturally into patterns.

Considerations for design patterns in Python

Object-oriented design patterns are ideas of software construction that appear in different scenarios when we deal with models of the problem we're solving. Because they're high-level ideas, it's hard to think of them as being tied to particular programming languages. They are instead more general concepts about how objects will interact in the application. Of course, they will have their implementation details, varying from language to language, but that doesn't form the essence of a design pattern.

That's the theoretical aspect of a design pattern, the fact that it is an abstract idea that expresses concepts about the layout of the objects in the solution. There are plenty of other books and several other resources about object-oriented design, and design patterns in particular, so in this book, we are going to focus on those implementation details for Python.

Given the nature of Python, some of the classical design patterns aren't actually needed. That means that Python already supports features that render those patterns invisible. Some argue that they don't exist in Python, but keep in mind that invisible doesn't mean non-existing. They are there, just embedded in Python itself, so it's likely that we won't even notice them.

Others have a much simpler implementation, again thanks to the dynamic nature of the language, and the rest of them are practically the same as they are in other platforms, with small differences.

In any case, the important goal for achieving clean code in Python is knowing what patterns to implement and how. That means recognizing some of the patterns that Python already abstracts and how we can leverage them. For instance, it would be completely non-Pythonic to try to implement the standard definition of the iterator pattern (as we would do in different languages), because (as we have already covered) iteration is deeply embedded in Python, and the fact that we can create objects that will directly work in a `for` loop makes this the right way to proceed.

Something similar happens with some of the creational patterns. Classes are regular objects in Python, and so are functions. As we have seen in several examples so far, they can be passed around, decorated, reassigned, and so on. That means that whatever kind of customization we would like to make to our objects, we can most likely do it without needing any particular setup of factory classes. In addition, there is no special syntax for creating objects in Python (no new keyword, for example). This is another reason why, most of the time, a simple function call will just work as a factory.

Other patterns are still needed, and we will see how, with some small adaptations, we can make them more Pythonic, taking full advantage of the features that the language provides (magic methods or the standard library).

Out of all the patterns available, not all of them are equally frequent, nor useful, so we will focus on the main ones, those that we would expect to see the most in our applications, and we will do so by following a pragmatic approach.

Design patterns in action

The canonical reference in this subject, as written by the GoF, introduces 23 design patterns, each falling under one of the creational, structural, and behavioral categories. There are even more patterns or variations of existing ones, but rather than learning all of these patterns off by heart, we should focus on keeping two things in mind. Some of the patterns are invisible in Python, and we use them probably without even noticing. Secondly, not all patterns are equally common; some of them are tremendously useful, and so they are found very frequently, while others are for more specific cases.

In this section, we will revisit the most common patterns, those that are most likely to emerge from our design. Note the use of the word *emerge* here. It is important. We should not force the application of a design pattern to the solution we are building, but rather evolve, refactor, and improve our solution until a pattern emerges.

Design patterns are therefore not invented but discovered. When a situation that occurs repeatedly in our code reveals itself, the general and more abstract layout of classes, objects, and related components appears under a name by which we identify a pattern.

Thinking the same thing, but now backward, we realize that the name of a design pattern wraps up a lot of concepts. This is probably the best thing about design patterns; they provide a language. Through design patterns, it's easier to communicate design ideas effectively. When two or more software engineers share the same vocabulary, and one of them mentions builder, the rest of them can immediately think about all the classes, and how they would be related, what their mechanics would be, and so on, without having to repeat this explanation all over again.

The reader will notice that the code shown in this chapter is different from the canonical or original envisioning of the design pattern in question. There is more than one reason for this. The first reason is that the examples take a more pragmatic approach, aimed at solutions for particular scenarios rather than exploring general design theory. The second reason is that the patterns are implemented with the particularities of Python, which in some cases are very subtle, but in other cases, the differences are noticeable, generally simplifying the code.

Creational patterns

In software engineering, creational patterns are those that deal with object instantiation, trying to abstract away much of the complexity (like determining the parameters to initialize an object, all the related objects that might be needed, etc.), in order to leave the user with a simpler interface, that should be safer to use. The basic form of object creation could result in design problems or added complexity to the design. Creational design patterns solve this problem by somehow controlling this object creation.

Out of the five patterns for creating objects, we will discuss mainly the variants that are used to avoid the singleton pattern, and replace it with the Borg pattern (most commonly used in Python applications), discussing their differences and advantages.

Factories

As was mentioned in the introduction, one of the core features of Python is that everything is an object, and as such, they can all be treated equally. This means that there are no special distinctions of things that we can or cannot do with classes, functions, or custom objects. They can all be passed by parameter, assigned, and so on.

It is for this reason that many of the factory patterns are not really needed. We could just simply define a function that will construct a set of objects, and we can even pass the class that we want to create by a parameter.

Singleton and shared state (monostate)

The singleton pattern, on the other hand, is something not entirely abstracted away by Python. The truth is that most of the time, this pattern is either not really needed or is a bad choice. There are a lot of problems with singletons (after all, they are, in fact, a form of global variables for object-oriented software, and as such, are a bad practice). They are hard to unit test, the fact that they might be modified at any time by any object makes them hard to predict, and their side-effects can be really problematic.

As a general principle, we should avoid using singletons as much as possible. If in some extreme case, they are required, the easiest way of achieving this in Python is by using a module. We can create an object in a module, and once it's there, it will be available from every part of the module that is imported. Python itself makes sure that modules are already singletons, in the sense that no matter how many times they're imported, and from how many places, the same module is always the one that is going to be loaded into `sys.modules`.

Shared state

Rather than forcing our design to have a singleton in which only one instance is created, no matter how the object is invoked, constructed, or initialized, it is better to replicate the data across multiple instances.

The idea of the monostate pattern (SNGMONO) is that we can have many instances that are just regular objects, without having to care whether they're singletons or not (seeing as they're just objects). The good thing about this pattern is that these objects will have their information synchronized, in a completely transparent way, without us having to worry about how this works internally.

This makes this pattern a much better choice, not only for its convenience, but also because it is less error-prone, and suffers from fewer of the disadvantages of singletons (regarding their testability, creating derived classes, and so on).

We can use this pattern on many levels, depending on how much information we need to synchronize.

In its simplest form, we can assume that we only need to have one attribute to be reflected across all instances. If that is the case, the implementation is as trivial as using a class variable, and we just need to take care in providing a correct interface to update and retrieve the value of the attribute.

Let's say we have an object that has to pull a version of a code in a Git repository by the latest `tag`. There might be multiple instances of this object, and when every client calls the method for fetching the code, this object will use the `tag` version from its attribute. At any point, this `tag` can be updated for a newer version, and we want any other instance (new or already created) to use this new branch when the `fetch` operation is being called, as shown in the following code:

```
class GitFetcher:
    _current_tag = None

    def __init__(self, tag):
        self.current_tag = tag

    @property
    def current_tag(self):
        if self._current_tag is None:
            raise AttributeError("tag was never set")
        return self._current_tag

    @current_tag.setter
    def current_tag(self, new_tag):
        self.__class__._current_tag = new_tag

    def pull(self):
        logger.info("pulling from %s", self.current_tag)
        return self.current_tag
```

The reader can simply verify that creating multiple objects of the `GitFetcher` type with different versions will result in all objects being set with the latest version at any time, as shown in the following code:

```
>>> f1 = GitFetcher(0.1)
>>> f2 = GitFetcher(0.2)
>>> f1.current_tag = 0.3
>>> f2.pull()
0.3
>>> f1.pull()
0.3
```

In the case that we need more attributes, or that we wish to encapsulate the shared attribute a bit more, to make the design cleaner, we can use a descriptor.

A descriptor, like the one shown in the following code, solves the problem, and while it's true that it requires more code, it also encapsulates a more concrete responsibility, and part of the code is actually moved away from our original class, making either one of them more cohesive and compliant with the single responsibility principle:

```
class SharedAttribute:
    def __init__(self, initial_value=None):
        self.value = initial_value
        self._name = None

    def __get__(self, instance, owner):
        if instance is None:
            return self
        if self.value is None:
            raise AttributeError(f"{self._name} was never set")
        return self.value

    def __set__(self, instance, new_value):
        self.value = new_value

    def __set_name__(self, owner, name):
        self._name = name
```

Apart from these considerations, it's also true that the pattern is now more reusable. If we want to repeat this logic, we just have to create a new descriptor object that would work (complying with the DRY principle).

If we now want to do the same, but for the current branch, we create this new class `attribute`, and the rest of the class is kept intact, while still having the desired logic in place, as shown in the following code:

```
class GitFetcher:
    current_tag = SharedAttribute()
    current_branch = SharedAttribute()

    def __init__(self, tag, branch=None):
        self.current_tag = tag
        self.current_branch = branch

    def pull(self):
        logger.info("pulling from %s", self.current_tag)
        return self.current_tag
```

The balance and trade-off of this new approach should be clear by now. This new implementation uses a bit more code, but it's reusable, so it saves lines of code (and duplicated logic) in the long run. Once again, refer to the three or more instances rule to decide if you should create such an abstraction.

Another important benefit of this solution is that it also reduces the repetition of unit tests. Reusing code here will give us more confidence on the overall quality of the solution, because now we just have to write unit tests for the descriptor object, not for all the classes that use it (we can safely assume that they're correct as long as the unit tests prove the descriptor to be correct).

The borg pattern

The previous solutions should work for most cases, but if we really have to go for a singleton (and this has to be a really good exception), then there is one last better alternative to it, only this is a riskier one.

This is the actual monostate pattern, referred to as the borg pattern in Python. The idea is to create an object that is capable of replicating all of its attributes among all instances of the same class. The fact that absolutely every attribute is being replicated has to be a warning to keep in mind undesired side-effects. Still, this pattern has many advantages over the singleton.

In this case, we are going to split the previous object into two—one that works over Git tags, and the other over branches. And we are using the code that will make the borg pattern work:

```
class BaseFetcher:
    def __init__(self, source):
        self.source = source

class TagFetcher(BaseFetcher):
    _attributes = {}

    def __init__(self, source):
        self.__dict__ = self.__class__.__attributes
        super().__init__(source)

    def pull(self):
        logger.info("pulling from tag %s", self.source)
        return f"Tag = {self.source}"

class BranchFetcher(BaseFetcher):
```

```
_attributes = {}

def __init__(self, source):
    self.__dict__ = self.__class__.__attributes
    super().__init__(source)

def pull(self):
    logger.info("pulling from branch %s", self.source)
    return f"Branch = {self.source}"
```

Both objects have a base class, sharing their initialization method. But then they have to implement it again in order to make the borg logic work. The idea is that we use a class attribute that is a dictionary to store the attributes, and then we make the dictionary of each object (at the time it's being initialized) to use this very same dictionary. This means that any update on the dictionary of an object will be reflected in the class, which will be the same for the rest of the objects because their class is the same, and dictionaries are mutable objects that are passed as a reference. In other words, when we create new objects of this type, they will all use the same dictionary, and this dictionary is constantly being updated.

Note that we cannot put the logic of the dictionary on the base class, because this will mix the values among the objects of different classes, which is not what we want. This boilerplate solution is what would make many think it's actually an idiom rather than a pattern.

A possible way of abstracting this in a way that achieves the DRY principle would be to create a mixin class, as shown in the following code:

```
class SharedAllMixin:
    def __init__(self, *args, **kwargs):
        try:
            self.__class__.__attributes
        except AttributeError:
            self.__class__.__attributes = {}

        self.__dict__ = self.__class__.__attributes
        super().__init__(*args, **kwargs)

class BaseFetcher:
    def __init__(self, source):
        self.source = source

class TagFetcher(SharedAllMixin, BaseFetcher):
    def pull(self):
        logger.info("pulling from tag %s", self.source)
```

```
        return f"Tag = {self.source}"

class BranchFetcher(SharedAllMixin, BaseFetcher):
    def pull(self):
        logger.info("pulling from branch %s", self.source)
        return f"Branch = {self.source}"
```

This time, we are using the mixin class to create the dictionary with the attributes in each class in case it doesn't already exist, and then continuing with the same logic.

This implementation should not have any major problems with inheritance, so it's a more viable alternative.

Builder

The builder pattern is an interesting pattern that abstracts away all the complex initialization of an object. This pattern does not rely on any particularity of the language, so it's as equally applicable in Python as it would be in any other language.

While it solves a valid case, it's usually also a complicated case that is more likely to appear in the design of a framework, library, or an API. Similar to the recommendations given for descriptors, we should reserve this implementation for cases where we expect to expose an API that is going to be consumed by multiple users.

The high level idea of this pattern is that we need to create a complex object, that is an object that also requires many others to work with. Rather than letting the user create all those auxiliary objects, and then assign them to the main one, we would like to create an abstraction that allows all of that to be done in a single step. In order to achieve this, we will have a builder object that knows how to create all the parts and link them together, giving the user an interface (which could be a class method), to parametrize all the information about what the resulting object should look like.

Structural patterns

Structural patterns are useful for situations where we need to create simpler interfaces or objects that are more powerful by extending their functionality without adding complexity to their interfaces.

The best thing about these patterns is that we can create more interesting objects, with enhanced functionality, and we can achieve this in a clean way; that is, by composing multiple single objects (the clearest example of this being the composite pattern), or by gathering many simple and cohesive interfaces.

Adapter

The adapter pattern is probably one of the simplest design patterns there are, and one of the most useful ones at the same time. Also known as a wrapper, this pattern solves the problem of adapting interfaces of two or more objects that are not compatible.

We typically encounter the situation where part of our code works with a model or set of classes that were polymorphic with respect to a method. For example, if there were multiple objects for retrieving data with a `fetch()` method, then we want to maintain this interface so we don't have to make major changes to our code.

But then we come to a point where the need to add a new data source, and alas, this one won't have a `fetch()` method. To make things worse, not only is this type of object not compatible, but it is also not something we control (perhaps a different team decided on the API, and we cannot modify the code).

Instead of using this object directly, we adopt its interface to the one we need. There are two ways of doing this.

The first way would be to create a class that inherits from the one we want to use, and that creates an alias for the method (if required, it will also have to adapt the parameters and the signature).

By means of inheritance, we import the external class and create a new one that will define the new method, calling the one that has a different name. In this example, let's say the external dependency has a method named `search()`, which takes only one parameter for the search because it queries in a different fashion, so our `adapter` method not only calls the external one, but it also translates the parameters accordingly, as shown in the following code:

```
from _adapter_base import UsernameLookup

class UserSource(UsernameLookup):
    def fetch(self, user_id, username):
        user_namespace = self._adapt_arguments(user_id, username)
        return self.search(user_namespace)
```

```
@staticmethod
def _adapt_arguments(user_id, username):
    return f"{user_id}:{username}"
```

It might be the case that our class already derives from another one, in which case, this will end up as a case of multiple inheritances, which Python supports, so it shouldn't be a problem. However, as we have seen many times before, inheritance comes with more coupling (who knows how many other methods are being carried from the external library?), and it's inflexible. Conceptually, it also wouldn't be the right choice because we reserve inheritance for situations of specification (an **is a** kind of relationship), and in this case, it's not clear at all that our object has to be one of the kinds that are provided by a third-party library (especially since we don't fully comprehend that object).

Therefore, a better approach would be to use composition instead. Assuming that we can provide our object with an instance of `UsernameLookup`, the code would be as simple as just redirecting the petition prior to adopting the parameters, as shown in the following code:

```
class UserSource:
    ...
    def fetch(self, user_id, username):
        user_namespace = self._adapt_arguments(user_id, username)
        return self.username_lookup.search(user_namespace)
```

If we need to adopt multiple methods, and we can devise a generic way of adapting their signature as well, it might be worth using the `__getattr__()` magic method to redirect requests towards the wrapped object, but as always with generic implementations, we should be careful of not adding more complexity to the solution.

Composite

There will be parts of our programs that require us to work with objects that are made out of other objects. We have base objects that have a well-defined logic, and then we will have other container objects that will group a bunch of base objects, and the challenge is that we want to treat both of them (the base and the container objects) without noticing any differences.

The objects are structured in a tree hierarchy, where the basic objects would be the leaves of the tree, and the composed objects intermediate nodes. A client might want to call any of them to get the result of a method that is called. The composite object, however, will act as a client; this also will pass this request along with all the objects it contains whether they are leaves or other intermediate notes until they all are processed.

Imagine a simplified version of an online store in which we have products. Say that we offer the possibility of grouping those products, and we give customers a discount per group of products. A product has a price, and this value will be asked for when the customers come to pay. But a set of grouped products also has a price that has to be computed. We will have an object that represents this group that contains the products, and that delegates the responsibility of asking the price to each particular product (which might be another group of products as well), and so on, until there is nothing else to compute. The implementation of this is shown in the following code:

```
class Product:
    def __init__(self, name, price):
        self._name = name
        self._price = price

    @property
    def price(self):
        return self._price

class ProductBundle:
    def __init__(
        self,
        name,
        perc_discount,
        *products: Iterable[Union[Product, "ProductBundle"]]
    ) -> None:
        self._name = name
        self._perc_discount = perc_discount
        self._products = products

    @property
    def price(self):
        total = sum(p.price for p in self._products)
        return total * (1 - self._perc_discount)
```

We expose the public interface through a property, and leave the `price` as a private attribute. The `ProductBundle` class uses this property to compute the value with the discount applied by first adding all the prices of all the products it contains.

The only discrepancy between these objects is that they are created with different parameters. To be fully compatible, we should have tried to mimic the same interface and then added extra methods for adding products to the bundle but using an interface that allows the creation of complete objects. Not needing these extra steps is an advantage that justifies this small difference.

Decorator

Don't confuse the decorator pattern with the concept of a Python decorator which we have gone through in [Chapter 5, Using Decorators to Improve Our Code](#). There is some resemblance, but the idea of the design pattern is quite different.

This pattern allows us to dynamically extend the functionality of some objects, without needing inheritance. It's a good alternative to multiple inheritance in creating more flexible objects.

We are going to create a structure that let's a user define a set of operations (decorations) to be applied over an object, and we'll see how each step takes place in the specified order.

The following code example is a simplified version of an object that constructs a query in the form of a dictionary from parameters that are passed to it (it might be an object that we would use for running queries to elasticsearch, for instance, but the code leaves out distracting implementation details to focus on the concepts of the pattern).

In its most basic form, the query just returns the dictionary with the data it was provided when it was created. Clients expect to use the `render()` method of this object:

```
class DictQuery:
    def __init__(self, **kwargs):
        self._raw_query = kwargs

    def render(self) -> dict:
        return self._raw_query
```

Now we want to render the query in different ways by applying transformations to the data (filtering values, normalizing them, and so on). We could create decorators and apply them to the `render` method, but that wouldn't be flexible enough what if we want to change them at runtime? Or if we want to select some of them, but not others?

The design is to create another object, with the same interface and the capability of enhancing (decorating) the original result through many steps, but which can be combined. These objects are chained, and each one of them does what it was originally supposed to do, plus something else. This something else is the particular decoration step.

Since Python has duck typing, we don't need to create a new base class and make these new objects part of that hierarchy, along with `DictQuery`. Simply creating a new class that has a `render()` method will be enough (again, polymorphism should not require inheritance). This process is shown in the following code:

```
class QueryEnhancer:
    def __init__(self, query: DictQuery):
```



```
        self.decorated = query

    def render(self):
        return self.decorated.render()

class RemoveEmpty(QueryEnhancer):
    def render(self):
        original = super().render()
        return {k: v for k, v in original.items() if v}

class CaseInsensitive(QueryEnhancer):
    def render(self):
        original = super().render()
        return {k: v.lower() for k, v in original.items()}
```

The `QueryEnhancer` phrase has an interface that is compatible with what the clients of `DictQuery` are expecting, so they are interchangeable. This object is designed to receive a decorated one. It's going to take the values from this and convert them, returning the modified version of the code.

If we want to remove all values that evaluate to `False` and normalize them to form our original query, we would have to use the following schema:

```
>>> original = DictQuery(key="value", empty="", none=None,
upper="UPPERCASE", title="Title")
>>> new_query = CaseInsensitive(RemoveEmpty(original))
>>> original.render()
{'key': 'value', 'empty': '', 'none': None, 'upper': 'UPPERCASE', 'title':
'Title'}
>>> new_query.render()
{'key': 'value', 'upper': 'uppercase', 'title': 'title'}
```

This is a pattern that we can also implement in different ways, taking advantage of the dynamic nature of Python, and the fact that functions are objects. We could implement this pattern with functions that are provided to the base decorator object (`QueryEnhancer`), and define each decoration step as a function, as shown in the following code:

```
class QueryEnhancer:
    def __init__(
        self,
        query: DictQuery,
        *decorators: Iterable[Callable[[Dict[str, str]], Dict[str, str]]]
    ) -> None:
        self._decorated = query
        self._decorators = decorators
```

```
def render(self):
    current_result = self._decorated.render()
    for deco in self._decorators:
        current_result = deco(current_result)
    return current_result
```

With respect to the client, nothing has changed because this class maintains the compatibility through its `render()` method. Internally, however, this object is used in a slightly different fashion, as shown in the following code:

```
>>> query = DictQuery(foo="bar", empty="", none=None, upper="UPPERCASE",
title="Title")
>>> QueryEnhancer(query, remove_empty, case_insensitive).render()
{'foo': 'bar', 'upper': 'uppercase', 'title': 'title'}
```

In the preceding code, `remove_empty` and `case_insensitive` are just regular functions that transform a dictionary.

In this example, the function-based approach seems easier to understand. There might be cases with more complex rules that rely on data from the object being decorated (not only its result), and in those cases, it might be worth going for the object-oriented approach, especially if we really want to create a hierarchy of objects where each class actually represents some knowledge we want to make explicit in our design.

Facade

Facade is an excellent pattern. It's useful in many situations where we want to simplify the interaction between objects. The pattern is applied where there is a relation of many-to-many among several objects, and we want them to interact. Instead of creating all of these connections, we place an intermediate object in front of many of them that act as a facade.

The facade works as a hub or a single point of reference in this layout. Every time a new object wants to connect to another one, instead of having to have N interfaces for all N possible objects it needs to connect to, it will instead just talk to the facade, and this will redirect the request accordingly. Everything that's behind the facade is completely opaque to the rest of the external objects.

Apart from the main and obvious benefit (the decoupling of objects), this pattern also encourages a simpler design with fewer interfaces and better encapsulation.

This is a pattern that we can use not only for improving the code of our domain problem but also to create better APIs. If we use this pattern and provide a single interface, acting as a single point of truth or entry point for our code, it will be much easier for our users to interact with the functionality exposed. Not only that, but by exposing a functionality and hiding everything behind an interface, we are free of changing or refactoring that underlying code as many times as we want, because as long as it is behind the facade, it will not break backward compatibility, and our users will not be affected.

Note how this idea of using facades is not even limited to objects and classes, but also applies to packages (technically, packages are objects in Python, but still). We can use this idea of the facade to decide the layout of a package; that is, what is visible to the user and importable, and what is internal and should not be imported directly.

When we create a directory to build a package, we place the `__init__.py` file along with the rest of the files. This is the root of the module, a sort of facade. The rest of the files define the objects to export, but they shouldn't be directly imported by clients. The `init` file should import them and then clients should get them from there. This creates a better interface because users only need to know a single entry point from which to get the objects, and more importantly, the package (the rest of the files) can be refactored or rearranged as many times as needed, and this will not affect clients as long as the main API on the `init` file is maintained. It is of utmost importance to keep principles like this one in mind in order to build maintainable software.

There is an example of this in Python itself, with the `os` module. This module groups an operating system's functionality, but underneath it, uses the `posix` module for **Portable Operating System Interface (POSIX)** operating systems (this is called `nt` in Windows platforms). The idea is that, for portability reasons, we shouldn't ever really import the `posix` module directly, but always the `os` module. It is up to this module to determine from which platform it is being called, and expose the corresponding functionality.

Behavioral patterns

Behavioral patterns aim to solve the problem of how objects should cooperate, how they should communicate, and what their interfaces should be at run-time.

We discuss mainly the following behavioral patterns:

- Chain of responsibility
- Template method
- Command
- State

This can be accomplished statically by means of inheritance or dynamically by using composition. Regardless of what the pattern uses, what we will see throughout the following examples is that what these patterns have in common is the fact that the resulting code is better in some significant way, whether this is because it avoids duplication or creates good abstractions that encapsulate behavior accordingly and decouple our models.

Chain of responsibility

Now we are going to take another look at our event systems. We want to parse information about the events that happened on the system from the log lines (text files, dumped from our HTTP application server, for example), and we want to extract this information in a convenient way.

In our previous implementation, we achieved an interesting solution that was compliant with the open/closed principle and relied on the use of the `__subclasses__()` magic method to discover all possible event types and process the data with the right event, resolving the responsibility through a method encapsulated on each class.

This solution worked for our purposes, and it was quite extensible, but as we'll see, this design pattern will bring additional benefits.

The idea here is that we are going to create the events in a slightly different way. Each event still has the logic to determine whether or not it can process a particular log line, but it will also have a successor. This successor is a new event, the next one in the line, that will continue processing the text line in case the first one was not able to do so. The logic is simple—we chain the events, and each one of them tries to process the data. If it can, then it just returns the result. If it can't, it will pass it to its successor and repeat, as shown in the following code:

```
import re

class Event:
    pattern = None

    def __init__(self, next_event=None):
        self.successor = next_event

    def process(self, logline: str):
        if self.can_process(logline):
            return self._process(logline)

        if self.successor is not None:
            return self.successor.process(logline)
```

```

def _process(self, logline: str) -> dict:
    parsed_data = self._parse_data(logline)
    return {
        "type": self.__class__.__name__,
        "id": parsed_data["id"],
        "value": parsed_data["value"],
    }

@classmethod
def can_process(cls, logline: str) -> bool:
    return cls.pattern.match(logline) is not None

@classmethod
def _parse_data(cls, logline: str) -> dict:
    return cls.pattern.match(logline).groupdict()

class LoginEvent(Event):
    pattern = re.compile(r"(?P<id>\d+):\s+login\s+(?P<value>\S+)")

class LogoutEvent(Event):
    pattern = re.compile(r"(?P<id>\d+):\s+logout\s+(?P<value>\S+)")

```

With this implementation, we create the event objects, and arrange them in the particular order in which they are going to be processed. Since they all have a `process()` method, they are polymorphic for this message, so the order in which they are aligned is completely transparent to the client, and either one of them would be transparent too. Not only that, but the `process()` method has the same logic; it tries to extract the information if the data provided is correct for the type of object handling it, and if not, it moves on to the next one in the line.

This way, we could process a login event in the following way:

```

>>> chain = LogoutEvent(LoginEvent())
>>> chain.process("567: login User")
{'type': 'LoginEvent', 'id': '567', 'value': 'User'}

```

Note how `LogoutEvent` received `LoginEvent` as its successor, and when it was asked to process something that it couldn't handle, it redirected to the correct object. As we can see from the `type` key on the dictionary, `LoginEvent` was the one that actually created that dictionary.

This solution is flexible enough, and shares an interesting trait with our previous one—all conditions are mutually exclusive. As long as there are no collisions, and no piece of data has more than one handler, processing the events in any order will not be an issue.

But what if we cannot make such an assumption? With the previous implementation, we could still change the `__subclasses__()` call for a list that we made according to our criteria, and that would have worked just fine. And what if we wanted that order of precedence to be determined at runtime (by the user or client, for example)? That would be a shortcoming.

With the new solution, it's possible to accomplish such requirements, because we assemble the chain at runtime, so we can manipulate it dynamically as we need to.

For example, now we add a generic type that groups both the login and logout a session event, as shown in the following code:

```
class SessionEvent(Event):
    pattern = re.compile(r"(?P<id>\d+):\s+log(in|out)\s+(?P<value>\S+)")
```

If for some reason, and in some part of the application, we want to capture this before the login event, this can be done by the following chain:

```
chain = SessionEvent(LoginEvent(LogoutEvent()))
```

By changing the order, we can, for instance, say that a generic session event has a higher priority than the login, but not the logout, and so on.

The fact that this pattern works with objects makes it more flexible with respect to our previous implementation, which relied on classes (and while they are still objects in Python, they aren't excluded from some degree of rigidity).

The template method

The `template` method is a pattern that yields important benefits when implemented properly. Mainly, it allows us to reuse code, and it also makes our objects more flexible and easy to change while preserving polymorphism.

The idea is that there is a class hierarchy that defines some behavior, let's say an important method of its public interface. All of the classes of the hierarchy share a common template and might need to change only certain elements of it. The idea, then, is to place this generic logic in the public method of the parent class that will internally call all other (private) methods, and these methods are the ones that the derived classes are going to modify; therefore, all the logic in the template is reused.

Avid readers might have noticed that we already implemented this pattern in the previous section (as part of the chain of responsibility example). Note that the classes derived from `Event` implement only one thing their particular pattern. For the rest of the logic, the template is in the `Event` class. The `process` event is generic, and relies on two auxiliary methods `can_process()` and `process()` (which in turn calls `_parse_data()`).

These extra methods rely on a class attribute pattern. Therefore, in order to extend this with a new type of object, we just have to create a new derived class and place the regular expression. After that, the rest of the logic will be inherited with this new attribute changed. This reuses a lot of code because the logic for processing the log lines is defined once and only once in the parent class.

This makes the design flexible because preserving the polymorphism is also easily achievable. If we need a new event type that for some reason needs a different way of parsing data, we only override this private method in that subclass, and the compatibility will be kept, as long as it returns something of the same type as the original one (complying with Liskov's substitution and open/closed principles). This is because it is the parent class that is calling the method from the derived classes.

This pattern is also useful if we are designing our own library or framework. By arranging the logic this way, we give users the ability to change the behavior of one of the classes quite easily. They would have to create a subclass and override the particular private method, and the result will be a new object with the new behavior that is guaranteed to be compatible with previous callers of the original object.

Command

The command pattern provides us with the ability to separate an action that needs to be done from the moment that it is requested to its actual execution. More than that, it can also separate the original request issued by a client from its recipient, which might be a different object. In this section, we are going to focus mainly on the first aspect of the patterns; the fact that we can separate how an order has to be run from when it actually executes.

We know we can create callable objects by implementing the `__call__()` magic method, so we could just initialize the object and then call it later on. In fact, if this is the only requirement, we might even achieve this through a nested function that, by means of a closure, creates another function to achieve the effect of a delayed execution. But this pattern can be extended to ends that aren't so easily achievable.

The idea is that the command might also be modified after its definition. This means that the client specifies a command to run, and then some of its parameters might be changed, more options added, and so on, until someone finally decides to perform the action.

Examples of this can be found in libraries that interact with databases. For instance, in `psycopg2` (a PostgreSQL client library), we establish a connection. From this, we get a cursor, and to that cursor we can pass an SQL statement to run. When we call the `execute` method, the internal representation of the object changes, but nothing is actually run in the database. It is when we call `fetchall()` (or a similar method) that the data is actually queried and is available in the cursor.

The same happens in the popular **Object Relational Mapper SQLAlchemy (ORM SQLAlchemy)**. A query is defined through several steps, and once we have the `query` object, we can still interact with it (add or remove filters, change the conditions, apply for an order, and so on), until we decide we want the results of the query. After calling each method, the `query` object changes its internal properties and returns `self` (itself).

These are examples that resemble the behavior that we would like to achieve. A very simple way of creating this structure would be to have an object that stores the parameters of the commands that are to be run. After that, it has to also provide methods for interacting with those parameters (adding or removing filters, and so on). Optionally, we can add tracing or logging capabilities to that object to audit the operations that have been taking place. Finally, we need to provide a method that will actually perform the action. This one can be just `__call__()` or a custom one. Let's call it `do()`.

State

The state pattern is a clear example of reification in software design, making the concept of our domain problem an explicit object rather than just a side value.

In *Chapter 8, Unit Testing and Refactoring*, we had an object that represented a merge request, and it had a state associated with it (open, closed, and so on). We used an enum to represent those states because, at that point, they were just data holding a value the string representation of that particular state. If they had to have some behavior, or the entire merge request had to perform some actions depending on its state and transitions, this would not have been enough.

The fact that we are adding behavior, a runtime structure, to a part of the code has to make us think in terms of objects, because that's what objects are supposed to do, after all. And here comes the reification—now the state cannot just simply be an enumeration with a string; it needs to be an object.

Imagine that we have to add some rules to the merge request say, that when it moves from open to closed, all approvals are removed (they will have to review the code again)—and that when a merge request is just opened, the number of approvals is set to zero (regardless of whether it's a reopened or a brand new merge request). Another rule could be that when a merge request is merged, we want to delete the source branch, and of course, we want to forbid users from performing invalid transitions (for example, a closed merge request cannot be merged, and so on).

If we were to put all that logic into a single place, namely in the `MergeRequest` class, we will end up with a class that has lots of responsibilities (a poor design), probably many methods, and a very large number of `if` statements. It would be hard to follow the code and to understand which part is supposed to represent which business rule.

It's better to distribute this into smaller objects, each one with fewer responsibilities, and the state objects are a good place for this. We create an object for each kind of state we want to represent, and, in their methods, we place the logic for the transitions with the aforementioned rules. The `MergeRequest` object will then have a state collaborator, and this, in turn, will also know about `MergeRequest` (the double-dispatching mechanism is needed to run the appropriate actions on `MergeRequest` and handle the transitions).

We define a base abstract class with the set of methods to be implemented, and then a subclass for each particular state we want to represent. Then the `MergeRequest` object delegates all the actions to `state`, as shown in the following code:

```
class InvalidTransitionError(Exception):
    """Raised when trying to move to a target state from an unreachable
    source
    state.
    """

class MergeRequestState(abc.ABC):
    def __init__(self, merge_request):
        self._merge_request = merge_request

    @abc.abstractmethod
    def open(self):
        ...
```

```
@abc.abstractmethod
def close(self):
    ...

@abc.abstractmethod
def merge(self):
    ...

def __str__(self):
    return self.__class__.__name__

class Open(MergeRequestState):
    def open(self):
        self._merge_request.approvals = 0

    def close(self):
        self._merge_request.approvals = 0
        self._merge_request.state = Closed

    def merge(self):
        logger.info("merging %s", self._merge_request)
        logger.info("deleting branch %s",
            self._merge_request.source_branch)
        self._merge_request.state = Merged

class Closed(MergeRequestState):
    def open(self):
        logger.info("reopening closed merge request %s",
            self._merge_request)
        self._merge_request.state = Open

    def close(self):
        pass

    def merge(self):
        raise InvalidTransitionError("can't merge a closed request")

class Merged(MergeRequestState):
    def open(self):
        raise InvalidTransitionError("already merged request")

    def close(self):
        raise InvalidTransitionError("already merged request")

    def merge(self):
```

```
    pass

class MergeRequest:
    def __init__(self, source_branch: str, target_branch: str) -> None:
        self.source_branch = source_branch
        self.target_branch = target_branch
        self._state = None
        self.approvals = 0
        self.state = Open

    @property
    def state(self):
        return self._state

    @state.setter
    def state(self, new_state_cls):
        self._state = new_state_cls(self)

    def open(self):
        return self.state.open()

    def close(self):
        return self.state.close()

    def merge(self):
        return self.state.merge()

    def __str__(self):
        return f"{self.target_branch}:{self.source_branch}"
```

The following list outlines some clarifications about implementation details and the design decisions that should be made:

- The state is a property, so not only is it public, but there is a single place with the definitions of how states are created for a merge request, passing `self` as a parameter.
- The abstract base class is not strictly needed, but there are benefits to having it. First, it makes the kind of object we are dealing with more explicit. Second, it forces every substate to implement all the methods of the interface. There are two alternatives to this:
 - We could have not put the methods, and let `AttributeError` raise when trying to perform an invalid action, but this is not correct, and it doesn't express what happened.

- Related to this point is the fact that we could have just used a simple base class and left those methods empty, but then the default behavior of not doing anything doesn't make it any clearer what should happen. If one of the methods in the subclass should do nothing (as in the case of merge), then it's better to let the empty method just sit there and make it explicit that for that particular case, nothing should be done, as opposed to force that logic to all objects.
- `MergeRequest` and `MergeRequestState` have links to each other. The moment a transition is made, the former object will not have extra references and should be garbage-collected, so this relationship should be always 1:1. With some small and more detailed considerations, a weak reference might be used.

The following code shows some examples of how the object is used:

```
>>> mr = MergeRequest("develop", "master")
>>> mr.open()
>>> mr.approvals
0
>>> mr.approvals = 3
>>> mr.close()
>>> mr.approvals
0
>>> mr.open()
INFO:log:reopening closed merge request master:develop
>>> mr.merge()
INFO:log:merging master:develop
INFO:log:deleting branch develop
>>> mr.close()
Traceback (most recent call last):
...
InvalidTransitionError: already merged request
```

The actions for transitioning states are delegated to the `state` object, which `MergeRequest` holds at all times (this can be any of the subclasses of `ABC`). They all know how to respond to the same messages (in different ways), so these objects will take the appropriate actions corresponding to each transition (deleting branches, raising exceptions, and so on), and will then move `MergeRequest` to the next state.

Since `MergeRequest` delegates all actions to its `state` object, we will find that this typically happens every time the actions that it needs to do are in the form `self.state.open()`, and so on. Can we remove some of that boilerplate?

We could, by means of `__getattr__()`, as it is portrayed in the following code:

```
class MergeRequest:
    def __init__(self, source_branch: str, target_branch: str) -> None:
        self.source_branch = source_branch
        self.target_branch = target_branch
        self._state: MergeRequestState
        self.approvals = 0
        self.state = Open

    @property
    def state(self):
        return self._state

    @state.setter
    def state(self, new_state_cls):
        self._state = new_state_cls(self)

    @property
    def status(self):
        return str(self.state)

    def __getattr__(self, method):
        return getattr(self.state, method)

    def __str__(self):
        return f"{self.target_branch}:{self.source_branch}"
```

On the one hand, it is good that we reuse some code and remove repetitive lines. This gives the abstract base class even more sense. Somewhere, we want to have all possible actions documented, listed in a single place. That place used to be the `MergeRequest` class, but now those methods are gone, so the only remaining source of that truth is in `MergeRequestState`. Luckily, the type annotation on the `state` attribute is really helpful for users to know where to look for the interface definition.

A user can simply take a look and see that everything that `MergeRequest` doesn't have will be asked of its `state` attribute. From the `init` definition, the annotation will tell us that this is an object of the `MergeRequestState` type, and by looking at this interface, we will see that we can safely ask for the `open()`, `close()`, and `merge()` methods on it.

The null object pattern

The null object pattern is an idea that relates to the good practices that were mentioned in previous chapters of this book. Here, we are formalizing them, and giving more context and analysis to this idea.

The principle is rather simple—functions or methods must return objects of a consistent type. If this is guaranteed, then clients of our code can use the objects that are returned with polymorphism, without having to run extra checks on them.

In the previous examples, we explored how the dynamic nature of Python made things easier for most design patterns. In some cases, they disappear entirely, and in others, they are much easier to implement. The main goal of design patterns as they were originally thought of is that methods or functions should not explicitly name the class of the object that they need in order to work. For this reason, they propose the creation of interfaces and a way of rearranging the objects to make them fit these interfaces in order to modify the design. But most of the time, this is not needed in Python, and we can just pass different objects, and as long as they respect the methods they must have, then the solution will work.

On the other hand, the fact that objects don't necessarily have to comply with an interface requires us to be more careful as to the things that are returning from such methods and functions. In the same way that our functions didn't make any assumptions about what they were receiving, it's fair to assume that clients of our code will not make any assumptions either (it is our responsibility to provide objects that are compatible). This can be enforced or validated with design by contract. Here, we will explore a simple pattern that will help us avoid these kinds of problems.

Consider the chain or responsibility design pattern explored in the previous section. We saw how flexible it is and its many advantages, such as decoupling responsibilities into smaller objects. One of the problems it has is that we never actually know what object will end up processing the message, if any. In particular, in our example, if there was no suitable object to process the log line, then the method would simply return `None`.

We don't know how users will use the data we passed, but we do know that they are expecting a dictionary. Therefore, the following error might occur:

```
AttributeError: 'NoneType' object has no attribute 'keys'
```

In this case, the fix is rather simple—the default value of the `process()` method should be an empty dictionary rather than `None`.

Ensure that you return objects of a consistent type.

But what if the method didn't return a dictionary, but a custom object of our domain?

To solve this problem, we should have a class that represents the empty state for that object and return it. If we have a class that represents users in our system, and a function that queries users by their ID, then in the case that a user is not found, it should do one of the following two things:

- Raise an exception
- Return an object of the `UserUnknown` type

But in no case should it return `None`. The phrase `None` doesn't represent what just happened, and the caller might legitimately try to ask methods to it, and it will fail with `AttributeError`.

We have discussed exceptions and their pros and cons earlier on, so we should mention that this `null` object should just have the same methods as the original user and do nothing for each one of them.

The advantage of using this structure is that not only are we avoiding an error at runtime but also that this object might be useful. It could make the code easier to test, and it can even, for instance, help in debugging (maybe we could put logging into the methods to understand why that state was reached, what data was provided to it, and so on).

By exploiting almost all of the magic methods of Python, it would be possible to create a generic `null` object that does absolutely nothing, no matter how it is called, but which can be called from almost any client. Such an object would slightly resemble a `Mock` object. It is not advisable to go down that path because of the following reasons:

- It loses meaning with the domain problem. Back in our example, having an object of the `UnknownUser` type makes sense, and gives the caller a clear idea that something went wrong with the query.
- It doesn't respect the original interface. This is problematic. Remember that the point is that an `UnknownUser` is a user, and therefore it must have the same methods. If the caller accidentally asks for a method that is not there, then, in that case, it should raise an `AttributeError` exception, and that would be good. With the generic `null` object that can do anything and respond to anything, we would be losing this information, and bugs might creep in. If we opt for creating a `Mock` object with `spec=User`, then this anomaly would be caught, but again, using a `Mock` object to represent what is actually an empty state harms the intention revealing the degree of the code.

This pattern is a good practice that allows us to maintain polymorphism in our objects.

Final thoughts about design patterns

We have seen the world of design patterns in Python, and in doing so, we have found solutions to common problems, as well as more techniques that will help us achieve a clean design.

All of this sounds good, but it begs the question, how good are design patterns? Some people argue that they do more harm than good, that they were created for languages whose limited type system (and lack of first-class functions) makes it impossible to accomplish things we would normally do in Python. Others claim that design patterns force a design solution, creating some bias that limits a design that would have otherwise emerged, and which would have been better. Let's look at each of these points in turn.

The influence of patterns over the design

A design patterns, as with any other topic in software engineering, cannot be good or bad in and of itself, but rather in how it's implemented. In some cases, there is actually no need for a design pattern, and a simpler solution would do. Trying to force a pattern where it doesn't fit is a case of over-engineering, and that's clearly bad, but it doesn't mean that there is a problem with the design patterns, and most likely in these scenarios, the problem is not even related to patterns at all. Some people try to over-engineer everything because they don't understand what flexible and adaptable software really means. As we mentioned before in this book, making good software is not about anticipating future requirements (there is no point in doing futurology), but just solving the problem that we have at hand right now, in a way that doesn't prevent us from making changes to it in the future. It doesn't have to handle those changes now; it just needs to be flexible enough so that it can be modified in the future. And when that future comes, we will still have to remember the rule of three or more instances of the same problem before coming up with a generic solution or a proper abstraction.

This is typically the point where the design patterns should emerge, once we have identified the problem correctly and are able to recognize the pattern and abstract accordingly.

Let's come back to the topic of the suitability of the patterns to the language. As we said in the introduction of the chapter, design patterns are high-level ideas. They typically refer to the relation of objects and their interactions. It's hard to think that such things might disappear from one language to another. It's true that some patterns are actually implemented manually in Python, as is the case of the iterator pattern (which, as it was heavily discussed earlier in the book, is built in Python), or a strategy (because, instead, we would just pass functions as any other regular object; we don't need to encapsulate the strategy method into an object the function itself would be an object).

But other patterns are actually needed, and they indeed solve problems, as in the case of the decorator and composite patterns. In other cases, there are design patterns that Python itself implements, and we just don't always see them, as in the case of the facade pattern that we discussed in the section on `os`.

As to our design patterns leading our solution in a wrong direction, we have to be careful here. Once again, it's better if we start designing our solution by thinking in terms of the domain problem and creating the right abstractions, and then later see whether there is a design pattern that emerges from that design. Let's say that it does. Is that a bad thing? The fact that there is already a solution to the problem we're trying to solve cannot be a bad thing. It would be bad to reinvent the wheel, as happens many times in our field. Moreover, the fact that we are applying a pattern, something already proven and validated, should give us greater confidence in the quality of what we are building.

Names in our models

Should we mention that we are using a design pattern in our code?

If the design is good and the code is clean, it should speak for itself. It is not recommended that you name things after the design patterns you are using for a couple of reasons:

- Users of our code and other developers don't need to know the design pattern behind the code, as long as it works as intended.
- Stating the design pattern ruins the intention revealing principle. Adding the name of the design pattern to a class makes it lose part of its original meaning. If a class represents a query, it should be named `Query` or `EnhancedQuery`, something that reveals the intention of what that object is supposed to do. `EnhancedQueryDecorator` doesn't mean anything meaningful, and the `Decorator` suffix creates more confusion than clarity.

Mentioning the design patterns in docstrings might be acceptable because they work as documentation, and expressing the design ideas (again, communicating) in our design is a good thing. However, this should not be needed. Most of the time, though, we do not need to know that a design pattern is there.

The best designs are those in which design patterns are completely transparent to the users. An example of this is how the facade pattern appears in the standard library, making it completely transparent to users as to how to access the `os` module. An even more elegant example is how the iterator design pattern is so completely abstracted by the language that we don't even have to think about it.

Summary

Design patterns have always been seen as proven solutions to common problems. This is a correct assessment, but in this chapter, we explored them from the point of view of good design techniques, patterns that leverage clean code. In most of the cases, we looked at how they provide a good solution to preserve polymorphism, reduce coupling, and create the right abstractions that encapsulate details as needed. All traits that relate to the concepts explored in [Chapter 8, Unit Testing and Refactoring](#).

Still, the best thing about design patterns is not the clean design we can obtain from applying them, but the extended vocabulary. Used as a communication tool, we can use their names to express the intention of our design. And sometimes, it's not the entire pattern that we need to apply, but we might need to take a particular idea (a substructure, for example) of a pattern from our solution, and here, too, they prove to be a way of communicating more effectively.

When we create solutions by thinking in terms of patterns, we are solving problems at a more general level. Thinking in terms of design patterns, brings us closer to higher-level design. We can slowly "zoom-out" and think more in terms of an architecture. And now that we are solving more general problems, it's time to start thinking about how the system is going to evolve and be maintained in the long run (how it's going to scale, change, adapt, and so on).

For a software project to be successful in these goals, it requires clean code at its core, but the architecture also has to be clean as well, which is what we are going to look at in the next chapter.

References

Here is a list of information you can refer to:

- *GoF*: The book written by Erich Gamma, Richard Helm, Ralph Johnson, and John Vlissides named *Design Patterns: Elements of Reusable Object-Oriented Software*
- *SNGMONO*: An article written by Robert C. Martin, 2002 named *SINGLETON and MONOSTATE*
- *The Null Object Pattern*, written by Bobby Woolf

10

Clean Architecture

In this final chapter, we focus on how everything fits together in the design of a whole system. This is a more theoretical chapter. Given the nature of the topic, it would be too complex to delve down into the more low-level details. Besides, the point is precisely to escape from those details, assume that all the principles explored in previous chapters are assimilated, and focus on the design of a system at scale.

The main concerns and goals for this chapter are as follows:

- Designing software systems that can be maintained in the long run
- Working effectively on a software project by maintaining quality attributes
- Studying how all concepts applied to code relate to systems in general

From clean code to clean architecture

This section is a discussion of how concepts that were emphasized in previous chapters reappear in a slightly different shape when we consider aspects of large systems. There is an interesting resemblance to how concepts that apply to more detailed design, as well as code, also apply to large systems and architectures.

The concepts explored in previous chapters were related to single applications, generally, a project, that might be a single repository (or a few), for a source control version system (git). This is not to say that those design ideas are only applicable to code, or that they are of no use when thinking of an architecture, for two reasons: the code is the foundation of the architecture, and, if it's not written carefully, the system will fail regardless of how well thought-out the architecture is.

Second, some principles that were revisited in previous chapters do not apply to code but are instead design ideas. The clearest example comes from design patterns. They are high-level ideas. With this, we can get a quick picture of how a component in our architecture might appear, without going into the details of the code.

But large enterprise systems typically consist of many of these applications, and now it's time to start thinking in terms of a larger design, in the form of a distributed system.

In the following sections, we discuss the main topics that have been discussed throughout the book, but now from the perspective of a system.

Separation of concerns

Inside an application, there are multiple components. Their code is divided into other subcomponents, such as modules or packages, and the modules into classes or functions, and the classes into methods. Throughout the book, the emphasis has been on keeping these components as small as possible, particularly in the case of functions—functions should do one thing, and be small.

Several reasons were presented to justify this rationale. Small functions are easier to understand, follow, and debug. They are also easier to test. The smaller the pieces in our code, the easier it will be to write unit tests for it.

For the components of each application, we wanted different traits, mainly high cohesion, and low coupling. By dividing components into smaller units, each one with a single and well-defined responsibility, we achieve a better structure where changes are easier to manage. In the face of new requirements, there will be a single rightful place to make the changes, and the rest of the code should probably be unaffected.

When we talk about code, we say *component* to refer to one of these cohesive units (it might be a class, for example). When speaking in terms of an architecture, a component means anything in the system that can be treated as a working unit. The term component itself is quite vague, so there is no universally accepted definition in software architecture of what this means more concretely. The concept of a working unit is something that can vary from project to project. A component should be able to be released or deployed with its own cycles, independently from the rest of the parts of the system. And it is precisely that, one of the parts of a system, is namely the entire application.

For Python projects, a component could be a package, but a service can also be a component. Notice how two different concepts, with different levels of granularity, can be considered under the same category. To give an example, the event systems we used in previous chapters could be considered a component. It's a working unit with a clearly defined purpose (to enrich events identified from logs), it can be deployed independently from the rest (whether as a Python package, or, if we expose its functionality, as a service), and it's a part of the entire system, but not the whole application itself.

On the examples of previous chapters we have seen an idiomatic code, and we have also highlighted the importance of good design for our code, with objects that have single well-defined responsibilities, being isolated, orthogonal, and easier to maintain. This very same criteria, which applies to detailed design (functions, classes, methods), also applies to the components of a software architecture.

It's probably undesirable for a large system to be just one component. A monolithic application will act as the single source of truth, responsible for everything in the system, and that will carry a lot of undesired consequences (harder to isolate and identify changes, to test effectively, and so on). In the same way, our code will be harder to maintain, if we are not careful and place everything in one place, the application will suffer from similar problems if its components aren't treated with the same level of attention.

The idea of creating cohesive components in a system can have more than one implementation, depending on the level of abstraction we require.

One option would be to identify common logic that is likely to be reused multiple times and place it in a Python package (we will discuss the details later in the chapter).

Another alternative would be to break the application into multiple smaller services, in a microservice architecture. The idea is to have components with a single and well-defined responsibility, and achieve the same functionality as a monolithic application by making those services cooperate, and exchange information.

Abstractions

This is where encapsulation appears again. From our systems (as we do in relation to the code), we want to speak in terms of the domain problem, and leave the implementation details as hidden as possible.

In the same way that the code has to be expressive (almost to the point of being self-documenting), and have the right abstractions that reveal the solution to the essential problem (minimizing accidental complexity), the architecture should tell us what the system is about. Details such as the solution used to persist data on disk, the web framework of choice, the libraries used to connect to external agents, and interaction between systems, are not relevant. What is relevant is what the system does. A concept such as a scream architecture (SCREAM) reflects this idea.

The **dependency inversion principle (DIP)**, explained in [Chapter 4, *The SOLID Principles*](#), is of great help in this regard; we don't want to depend upon concrete implementations but rather abstractions. In the code, we place abstractions (or interfaces) on the boundaries, the dependencies, those parts of the application that we don't control and might change in the future. We do this because we want to invert the dependencies. Let them have to adapt to our code (by having to comply with an interface), and not the other way round.

Creating abstractions and inverting dependencies are good practices, but they're not enough. We want our entire application to be independent and isolated from things that are out of our control. And this is even more than just abstracting with objects—we need layers of abstraction.

This is a subtle, but important difference with respect to the detailed design. In the DIP, it was recommended to create an interface, that could be implemented with the `abc` module from the standard library, for instance. Because Python works with duck typing, while using an abstract class might be helpful, it's not mandatory, as we can easily achieve the same effect with regular objects as long as they comply with the required interface. The dynamic typing nature of Python allowed us to have these alternatives. When thinking in terms of architecture, there is no such a thing. As it will become clearer with the example, we need to abstract dependencies entirely, and there is no feature of Python that can do that for us.

Some might argue "Well, the ORM is a good abstraction for a database, isn't it?" It's not enough. The ORM itself is a dependency and, as such, out of our control. It would be even better to create an intermediate layer, an adapter, between the API of the ORM and our application.

This means that we don't abstract the database just with an ORM; we use the abstraction layer we create on top of it, to define objects of our own that belong to our domain.

The application then imports this component, and uses the entities provided by this layer, but not the other way round. The abstraction layer should not know about the logic of our application; it's even truer that the database should know nothing about the application itself. If that were the case, the database would be coupled to our application. The goal is to invert the dependency—this layer provides an API, and every storage component that wants to connect has to conform to this API. This is the concept of a hexagonal architecture (HEX).

Software components

We have a large system now, and we need to scale it. It also has to be maintainable. At this point, the concerns aren't only technical but also organizational. This means it's not just about managing software repositories; each repository will most likely belong to an application, and it will be maintained by a team who owns that part of the system.

This demands we keep in mind how a large system is divided into different components. This can have many phases, from a very simple approach about, say, creating Python packages, to more complex scenarios in a microservice architecture.

The situation could be even more complex when different languages are involved, but in this chapter, we will assume they are all Python projects.

These components need to interact, as do the teams. The only way this can work at scale is if all the parts agree on an interface, a contract.

Packages

A Python package is a convenient way to distribute software and reuse code in a more general way. Packages that have been built can be published to an artifact repository (such as an internal PyPi server for the company), from where it will be downloaded by the rest of the applications that require it.

The motivation behind this approach has many elements to it—it's about reusing code at large, and also achieving conceptual integrity.

Here, we discuss the basics of packaging a Python project that can be published in a repository. The default repository might be PyPi (<https://pypi.org/>), but also internal; or custom setups will work with the same basics.

We are going to simulate that we have created a small library, and we will use that as an example to review the main points to take into consideration.

Aside from all the open source libraries available, sometimes we might need some extra functionality—perhaps our application uses a particular idiom repeatedly or relies on a function or mechanism quite heavily and the team has devised a better function for these particular needs. In order to work more effectively, we can place this abstraction into a library, and encourage all team members to use the idioms as provided by it, because doing so will help avoid mistakes and reduce bugs.

Potentially, there are infinite examples that could suit this scenario. Maybe the application needs to extract a lot of `.tag.gz` files (in a particular format) and has faced security problems in the past with malicious files that ended up with path traversal attacks. As a mitigation measure, the functionality for abstracting custom file formats securely was put in a library that wraps the default one and adds some extra checks. This sounds like a good idea.

Or maybe there is a configuration file that has to be written, or parsed in a particular format, and this requires many steps to be followed in order; again, creating a helper function to wrap this, and using it in all the projects that need it, constitutes a good investment, not only because it saves a lot of code repetition, but also because it makes it harder to make mistakes.

The gain is not only complying with the DRY principle (avoiding code duplication, encouraging reuse) but also that the abstracted functionality represents a single point of reference of how things should be done, hence contributing to the attainment of conceptual integrity.

In general, the minimum layout for a library would look like this:

```
.
├── Makefile
├── README.rst
├── setup.py
├── src
│   ├── apptool
│   ├── common.py
│   ├── __init__.py
│   └── parse.py
├── tests
│   └── integration
└── unit
```

The important part is the `setup.py` file, which contains the definition for the package. In this file, all the important definitions of the project (its requirements, dependencies, name, description, and so on) are specified.

The `apptool` directory under `src` is the name of the library we're working on. This is a typical Python project, so we place here all the files we need.

An example of the `setup.py` file could be:

```
from setuptools import find_packages, setup

with open("README.rst", "r") as longdesc:
    long_description = longdesc.read()

setup(
    name="apptool",
    description="Description of the intention of the package",
    long_description=long_description,
    author="Dev team",
    version="0.1.0",
    packages=find_packages(where="src/"),
    package_dir={"": "src"},
)
```

This minimal example contains the key elements of the project. The `name` argument in the `setup` function is used to give the name that the package will have in the repository (under this name, we run the command to install it, in this case its `pip install apptool`). It's not strictly required that it matches the name of the project directory (`src/apptool`), but it's highly recommended, so its easier for users.

In this case, since both names match, it's easier to see the relationship between what `pip install apptool` and then, in our code, run `from apptool import myutil`. But the latter corresponds to the name under the `src/` directory and the former to the one specified in the `setup.py` file.

The version is important to keep different releases going on, and then the packages are specified. By using the `find_packages()` function, we automatically discover everything that's a package, in this case under the `src/` directory. Searching under this directory helps to avoid mixing up files beyond the scope of the project and, for instance, accidentally releasing tests or a broken structure of the project.

A package is built by running the following commands, assuming its run inside a virtual environment with the dependencies installed:

```
$VIRTUAL_ENV/bin/pip install -U setuptools wheel
$VIRTUAL_ENV/bin/python setup.py sdist bdist_wheel
```

This will place the artifacts in the `dist/` directory, from where they can be later published either to PyPi or to the internal package repository of the company.

The key points in packaging a Python project are:

- Test and verify that the installation is platform-independent and that it doesn't rely on any local setup (this can be achieved by placing the source files under an `src/` directory)
- Make sure that unit tests aren't shipped as part of the package being built
- Separate dependencies—what the project strictly needs to run is not the same as what developers require
- It's a good idea to create entry points for the commands that are going to be required the most

The `setup.py` file supports multiple other parameters and configurations and can be effected in a much more complicated manner. If our package requires several operating system libraries to be installed, it's a good idea to write some logic in the `setup.py` file to compile and build the extensions that are required. This way, if something is amiss, it will fail early on in the installation process, and if the package provides a helpful error message, the user will be able to fix the dependencies more quickly and continue.

Installing such dependencies represents another difficult step in making the application ubiquitous, and easy to run by any developer regardless of their platform of choice. The best way to surmount this obstacle is to abstract the platform by creating a Docker image, as we will discuss in the next section.

Containers

This chapter is dedicated to architecture, so the term container refers to something completely different from a Python container (an object with a `__contains__` method), explored in [Chapter 2, Pythonic Code](#). A container is a process that runs in the operating system under a group with certain restrictions and isolation considerations. Concretely we refer to Docker containers, which allow managing applications (services or processes) as independent components.

Containers represent another way of delivering software. Creating Python packages taking into account the considerations in the previous section is more suitable for libraries, or frameworks, where the goal is to reuse code and take advantage of using a single place where specific logic is gathered.

In the case of containers, the objective will not be creating libraries but applications (most of the time). However, an application or platform does not necessarily mean an entire service. The idea of building containers is to create small components that represent a service with a small and clear purpose.

In this section, we will mention Docker when we talk about containers, and we will explore the basics of how to create Docker images and containers for Python projects. Keep in mind that this is not the only technology for launching applications into containers, and also that it's completely independent of Python.

A Docker container needs an image to run on, and this image is created from other base images. But the images we create can themselves serve as base images for other containers. We will want to do that in cases where there is a common base in our application that can be shared across many containers. A potential use would be creating a base image that installs a package (or many) in the way we described in the previous section, and also all of its dependencies, including those at the operating system level. As discussed in [Chapter 9, *Common Design Patterns*](#), a package we create can depend not only on other Python libraries, but also on a particular platform (a specific operating system), and particular libraries preinstalled in that operating system, without which the package will simply not install and will fail.

Containers are a great portability tool for this. They can help us ensure that our application will have a canonical way of running, and it will also ease the development process a lot (reproducing scenarios across environments, replicating tests, on-boarding new team members, and so on).

As packages are the way we reuse code and unify criteria, containers represent the way we create the different services of the application. They meet the criteria behind the principle of **separation of concerns (SoC)** of the architecture. Each service is another kind of component that will encapsulate a set of functionalities independently of the rest of the application. These containers ought to be designed in such a way that they favor maintainability—if the responsibilities are clearly divided, a change in a service should not impact any other part of the application whatsoever.

We cover the basics of how to create a Docker container from a Python project in the next section.

Use case

As an example of how we might organize the components of our application, and how the previous concepts might work in practice, we present the following simple example.

The use case is that there is an application for delivering food, and this application has a specific service for tracking the status of each delivery at its different stages. We are going to focus only on this particular service, regardless of how the rest of the application might appear. The service has to be really simple—a REST API that, when asked about the status of a particular order, will return a JSON response with a descriptive message.

We are going to assume that the information about each particular order is stored in a database, but this detail should not matter at all.

Our service has two main concerns for now: getting the information about a particular order (from wherever this might be stored), and presenting this information in a useful way to the clients (in this case, delivering the results in JSON format, exposed as a web service).

As the application has to be maintainable and extensible, we want to keep these two concerns as hidden as possible and focus on the main logic. Therefore, these two details are abstracted and encapsulated into Python packages that the main application with the core logic will use, as shown in the following diagram:

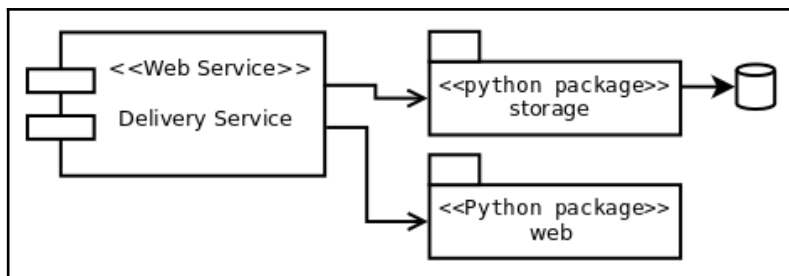

In the following sections, we briefly demonstrate how the code might appear, in terms of the packages mainly, and how to create services from these, in order to finally see what conclusions we can infer.

The code

The idea of creating Python packages in this example is to illustrate how abstracted and isolated components can be made, in order to work effectively. In reality, there is no actual need for these to be Python packages; we could just create the right abstractions as part of the "delivery service" project, and, while the correct isolation is preserved, it will work without any issues.

Creating packages makes more sense when there is logic that is going to be repeated and is expected to be used across many other applications (that will import from those packages) because we want to favor code reuse. In this particular case, there are no such requirements, so it might be beyond the scope of the design, but such distinction still makes more clear the idea of a "pluggable architecture" or component, something that is really a wrapper abstracting technical details we don't really want to deal with, much less depend upon.

The `storage` package is in charge of retrieving the data that is required, and presenting this to the next layer (the delivery service) in a convenient format, something that is suitable for the business rules. The main application should now know where this data came from, what its format is, and so on. This is the entire reason why we have such an abstraction in between so the application doesn't use a row or an ORM entity directly, but rather something workable.

Domain models

The following definitions apply to classes for business rules. Notice that they are meant to be pure business objects, not bound to anything in particular. They aren't models of an ORM, or objects of an external framework, and so on. The application should work with these objects (or objects with the same criteria).

In each case, the docstring documents the purpose of each class, according to the business rule:

```
from typing import Union

class DispatchedOrder:
    """An order that was just created and notified to start its
    delivery."""

    status = "dispatched"

    def __init__(self, when):
        self._when = when
```

```
    def message(self) -> dict:
        return {
            "status": self.status,
            "msg": "Order was dispatched on {}".format(
                self._when.isoformat()
            ),
        }

class OrderInTransit:
    """An order that is currently being sent to the customer."""

    status = "in transit"

    def __init__(self, current_location):
        self._current_location = current_location

    def message(self) -> dict:
        return {
            "status": self.status,
            "msg": "The order is in progress (current location:
{}))".format(
                self._current_location
            ),
        }

class OrderDelivered:
    """An order that was already delivered to the customer."""

    status = "delivered"

    def __init__(self, delivered_at):
        self._delivered_at = delivered_at

    def message(self) -> dict:
        return {
            "status": self.status,
            "msg": "Order delivered on {}".format(
                self._delivered_at.isoformat()
            ),
        }

class DeliveryOrder:
    def __init__(
        self,
        delivery_id: str,
```

```
        status: Union[DispatchedOrder, OrderInTransit, OrderDelivered],
    ) -> None:
        self._delivery_id = delivery_id
        self._status = status

    def message(self) -> dict:
        return {"id": self._delivery_id, **self._status.message()}
```

From this code, we can already get an idea of what the application will look like—we want to have a `DeliveryOrder` object, which will have its own status (as an internal collaborator), and once we have that, we will call its `message()` method to return this information to the user.

Calling from the application

Here is how these objects are going to be used in the application. Notice how this depends on the previous packages (`web` and `storage`), but not the other way round:

```
from storage import DBClient, DeliveryStatusQuery, OrderNotFoundError
from web import NotFound, View, app, register_route

class DeliveryView(View):
    async def _get(self, request, delivery_id: int):
        dsq = DeliveryStatusQuery(int(delivery_id), await DBClient())
        try:
            result = await dsq.get()
        except OrderNotFoundError as e:
            raise NotFound(str(e)) from e

        return result.message()

register_route(DeliveryView, "/status/<delivery_id:int>")
```

In the previous section, the domain objects were shown and here the code for the application is displayed. Aren't we missing something? Sure, but is it something we really need to know now? Not necessarily.

The code inside the `storage` and `web` packages was deliberately left out (although the reader is more than encouraged to look at it—the repository for the book contains the full example). Also, and this was done on purpose, the names of such packages were chosen so as not to reveal any technical detail—`storage` and `web`.

Look again at the code in the previous listing. Can you tell which frameworks are being used? Does it say whether the data comes from a text file, a database (if so, of what type? SQL? NoSQL?), or another service (the web, for instance)? Assume that it comes from a relational database. Is there any clue to how this information is retrieved (manual SQL queries? Through an ORM?)?

What about the web? Can we guess what frameworks are used?

The fact that we cannot answer any of those questions is probably a good sign. Those are details, and details ought to be encapsulated. We can't answer those questions unless we take a look at what's inside those packages.

There is another way of answering the previous questions, and it comes in the form of a question itself: why do we need to know that? Looking at the code, we can see that there is a `DeliveryOrder`, created with an identifier of a delivery, and it that has a `get()` method, which returns an object representing the status of the delivery. If all of this information is correct, that's all we should care about. What difference does it make how is it done?

The abstractions we created make our code declarative. In declarative programming, we declare the problem we want to solve, not how we want to solve it. It's the opposite of imperative, in which we have to make all the steps required explicit in order to get something (for instance connect to the database, run this query, parse the result, load it into this object, and so on). In this case, we are declaring that we just want to know the status of the delivery given by some identifier.

These packages are in charge of dealing with the details and presenting what the application needs in a convenient format, namely objects of the kind presented in the previous section. We just have to know that the `storage` package contains an object that, given an ID for a delivery and a storage client (this dependency is being injected into this example for simplicity, but other alternatives are also possible), it will retrieve `DeliveryOrder` which we can then ask to compose the message.

This architecture provides convenience and makes it easier to adapt to changes, as it protects the kernel of the business logic from the external factors that can change.

Imagine we want to change how the information is retrieved. How hard would that be? The application relies on an API, like the following one:

```
dsg = DeliveryStatusQuery(int(delivery_id), await DBClient())
```

So it would be about just changing how the `get ()` method works, adapting it to the new implementation detail. All we need is for this new object to return `DeliveryOrder` on its `get ()` method and that would be all. We can change the query, the ORM, the database, and so on, and, in all cases, the code in the application does not need to change!

Adapters

Still, without looking at the code in the packages, we can conclude that they work as interfaces for the technical details of the application.

In fact, since we are seeing the application from a high-level perspective, without needing to look at the code, we can imagine that inside those packages there must be an implementation of the adapter design pattern (introduced in [Chapter 9, *Common Design Patterns*](#)). One or more of these objects is adapting an external implementation to the API defined by the application. This way, dependencies that want to work with the application must conform to the API, and an adapter will have to be made.

There is one clue pertaining to this adapter in the code for the application though. Notice how the view is constructed. It inherits from a class named `View` that comes from our `web` package. We can deduce that this `View` is, in turn, a class derived from one of the web frameworks that might be being used, creating an adapter by inheritance. The important thing to note is that once this is done, the only object that matters is our `View` class, because, in a way, we are creating our own framework, which is based on adapting an existing one (but again changing the framework will mean just changing the adapters, not the entire application).

The services

To create the service, we are going to launch the Python application inside a Docker container. Starting from a base image, the container will have to install the dependencies for the application to run, which also has dependencies at the operating system level.

This is actually a choice because it depends on how the dependencies are used. If a package we use requires other libraries on the operating system to compile at installation time, we can avoid this simply by building a wheel for our platform of the library and installing this directly. If the libraries are needed at runtime, then there is no choice but to make them part of the image of the container.

Now, we discuss one of the many ways of preparing a Python application to be run inside a Docker container. This is one of numerous alternatives for packaging a Python project into a container. First, we take a look at what the structure of the directories looks like:

```
.
├── Dockerfile
├── libs
│   ├── README.rst
│   ├── storage
│   └── web
├── Makefile
├── README.rst
├── setup.py
├── statusweb
│   ├── __init__.py
│   └── service.py
```

The `libs` directory can be ignored since it's just the place where the dependencies are placed (it's displayed here to keep them in mind when they are referenced in the `setup.py` file, but they could be placed in a different repository and installed remotely via `pip`).

We have `Makefile` with some helper commands, then the `setup.py` file, and the application itself inside the `statusweb` directory. A common difference between packaging applications and libraries is that while the latter specify their dependencies in the `setup.py` file, the former have a `requirements.txt` file from where dependencies are installed via `pip install -r requirements.txt`. Normally, we would do this in the `Dockerfile`, but in order to keep things simpler in this particular example, we will assume that taking the dependencies from the `setup.py` file is enough. This is because, besides this consideration, there are a lot more considerations to be taken into account when dealing with dependencies, such as freezing the version of the packages, tracking indirect dependencies, using extra tools such as `pipenv`, and more topics that are beyond the scope of the chapter. In addition, it is also customary to make the `setup.py` file read from `requirements.txt` for consistency.

Now we have the content of the `setup.py` file, which states some details of the application:

```
from setuptools import find_packages, setup

with open("README.rst", "r") as longdesc:
    long_description = longdesc.read()

install_requires = ["web", "storage"]

setup(
```

```
name="delistatus",
description="Check the status of a delivery order",
long_description=long_description,
author="Dev team",
version="0.1.0",
packages=find_packages(),
install_requires=install_requires,
entry_points={
    "console_scripts": [
        "status-service = statusweb.service:main",
    ],
},
)
```

The first thing we notice is that the application declares its dependencies, which are the packages we created and placed under `libs/`, namely `web` and `storage`, abstracting and adapting to some external components. These packages, in turn, will have dependencies, so we will have to make sure the container installs all the required libraries when the image is being created so that they can install successfully, and then this package afterward.

The second thing we notice is the definition of the `entry_points` keyword argument passed to the `setup` function. This is not strictly mandatory, but it's a good idea to create an entry point. When the package is installed in a virtual environment, it shares this directory along with all its dependencies. A virtual environment is a structure of directories with the dependencies of a given project. It has many subdirectories, but the most important ones are:

- `<virtual-env-root>/lib/<python-version>/site-packages`
- `<virtual-env-root>/bin`

The first one contains all the libraries installed in that virtual environment. If we were to create a virtual environment with this project, that directory would contain the `web`, and `storage` packages, along with all its dependencies, plus some extra basic ones and the current project itself.

The second, `/bin/`, contains the binary files and commands available when that virtual environment is active. By default, it would just be the version of Python, `pip`, and some other basic commands. When we create an entry point, a binary with that declared name is placed there, and, as a result, we have that command available to run when the environment is active. When this command is called, it will run the function that is specified with all the context of the virtual environment. That means it is a binary we can call directly without having to worry about whether the virtual environment is active, or whether the dependencies are installed in the path that is currently running.

The definition is the following one:

```
"status-service = statusweb.service:main"
```

The left-hand side of the equals sign declares the name of the entry point. In this case, we will have a command named `status-service` available. The right-hand side declares how that command should be run. It requires the package where the function is defined, followed by the function name after `:`. In this case, it will run the `main` function declared in `statusweb/service.py`.

This is followed by a definition of the Dockerfile:

```
FROM python:3.6.6-alpine3.6

RUN apk add --update \
    python-dev \
    gcc \
    musl-dev \
    make

WORKDIR /app
ADD . /app

RUN pip install /app/libs/web /app/libs/storage
RUN pip install /app

EXPOSE 8080
CMD ["/usr/local/bin/status-service"]
```

The image is built based on a lightweight Python image, and then the operating system dependencies are installed so that our libraries can be installed. Following the previous consideration, this Dockerfile simply copies the libraries, but this might as well be installed from a `requirements.txt` file accordingly. After all the `pip install` commands are ready, it copies the application in the working directory, and the entry point from Docker (the `CMD` command, not to be confused with the Python one) calls the entry point of the package where we placed the function that launches the process.

All the configuration is passed by environment variables, so the code for our service will have to comply with this norm.

In a more complex scenario involving more services and dependencies, we will not just run the image of the created container, but instead declare a `docker-compose.yml` file with the definitions of all the services, base images, and how they are linked and interconnected.

Now that we have the container running, we can launch it and run a small test on it to get an idea of how it works:

```
$ curl http://localhost:8080/status/1
{"id":1, "status":"dispatched", "msg":"Order was dispatched on
2018-08-01T22:25:12+00:00"}
```

Analysis

There are many conclusions to be drawn from the previous implementation. While it might seem like a good approach, there are cons that come with the benefits; after all, no architecture or implementation is perfect. This means that a solution such as this one cannot be good for all cases, so it will pretty much depend on the circumstances of the project, the team, the organization, and more.

While it's true that the main idea of the solution is to abstract details as much as possible, as we shall see some parts cannot be fully abstracted away, and also the contracts between the layers imply an abstraction leak.

The dependency flow

Notice that dependencies flow in only one direction, as they move closer to the kernel, where the business rules lie. This can be traced by looking at the `import` statements. The application imports everything it needs from storage, for example, and in no part is this inverted.

Breaking this rule would create coupling. The way the code is arranged now means that there is a weak dependency between the application and storage. The API is such that we need an object with a `get()` method, and any storage that wants to connect to the application needs to implement this object according to this specification. The dependencies are therefore inverted—it's up to every storage to implement this interface, in order to create an object according to what the application is expecting.

Limitations

Not everything can be abstracted away. In some cases, it's simply not possible, and in others, it might not be convenient. Let's start with the convenience aspect.

In this example, there is an adapter of the web framework of choice to a clean API to be presented to the application. In a more complex scenario, such a change might not be possible. Even with this abstraction, parts of the library were still visible to the application. Adapting an entire framework might not only be hard but also not possible in some cases. It's not entirely a problem to be completely isolated from the web framework because, sooner or later, we will need some of its features or technical details.

The important takeaway here is not the adapter, but the idea of hiding technical details as much as possible. That means, that the best thing that was displayed on the listing for the code of the application was not the fact that there was an adapter between our version of the web framework and the actual one, but instead the fact that the latter was not mentioned by name in any part of the visible code. The service was made clear that `web` was just a dependency (a detail being imported), and revealed the intention behind what it was supposed to do. The goal is to reveal the intention (as in the code) and to defer details as much as possible.

As to what things cannot be isolated, those are the elements that are closest to the code. In this case, the web application was using the objects operating within them in an asynchronous fashion. That is a hard constraint we cannot circumvent. It's true that whatever is inside the `storage` package can be changed, refactored, and modified, but whatever these modifications might be, it still needs to preserve the interface, and that includes the asynchronous interface.

Testability

Again, much like with the code, the architecture can benefit from separating pieces into smaller components. The fact that dependencies are now isolated and controlled by separate components leaves us with a cleaner design for the main application, and now it's easier to ignore the boundaries to focus on testing the core of the application.

We could create a patch for the dependencies, and write unit tests that are simpler (they won't need a database), or to launch an entire web service, for instance. Working with pure `domain` objects means it will be easier to understand the code and the unit tests. Even the adapters will not need that much testing because their logic should be very simple.

Intention revealing

These details included keeping functions short, concerns separated, dependencies isolated, and assigning the right meaning to abstractions in every part of the code. Intention revealing was a critical concept for our code—every name has to be wisely chosen, clearly communicating what it's supposed to do. Every function should tell a story.

A good architecture should reveal the intent of the system it entails. It should not mention the tools it's built with; those are details, and as we discussed at length, details should be hidden, encapsulated.

Summary

The principles for good software design apply on all levels. In the same way that we want to write readable code, and for that we need to mind the intention revealing degree of the code, the architecture also has to express the intent of the problem it is trying to solve.

All these ideas are interconnected. The same intention revealing that ensures our architecture is defined in terms of the domain problem also leads us to abstract details as much as possible, create layers of abstraction, invert dependencies, and separate concerns.

When it comes to reusing code, Python packages are a great and flexible alternative. Criteria, such as cohesion and the **single responsibility principle (SRP)**, are the most important considerations when deciding to create a package. In line with having components with cohesion and few responsibilities, the concept of microservices comes into play, and for that, we have seen how a service can be deployed in a Docker container starting from a packaged Python application.

As with everything in software engineering, there are limitations, and there are exceptions. It will not always be possible to abstract things as much as we would like to or to completely isolate dependencies. Sometimes, it will just not be possible (or practical) to comply with the principles explained here in the book. But that is probably the best piece of advice the reader should take from the book—they are just principles, not laws. If it's not possible, or practical, to abstract from a framework, it should not be a problem. Remember what has been quoted from the zen of Python itself, throughout the book—**practicality beats purity**.

References

Here is a list of information you can refer to:

- *SCREAM: The Screaming Architecture* (<https://8thlight.com/blog/uncle-bob/2011/09/30/Screaming-Architecture.html>)
- *CLEAN-01: The Clean Architecture* (<https://8thlight.com/blog/uncle-bob/2012/08/13/the-clean-architecture.html>)
- *HEX: Hexagonal Architecture* (<https://staging.cockburn.us/hexagonal-architecture/>)
- *PEP-508: Dependency specification for Python software packages* (<https://www.python.org/dev/peps/pep-0508/>)
- *Packaging and distributing projects in Python* (<https://python-packaging-user-guide.readthedocs.io/guides/distributing-packages-using-setuptools/#distributing-packages>)

Summing it all up

The content of the book is a reference, a possible way of implementing a software solution by following criteria. These criteria are explained through examples, and the rationale for every decision presented. The reader might very well disagree with the approach taken on the examples, and this is actually desirable: the more viewpoints, the richer the debate. But regardless of opinions, it's important to make clear that what is presented here is by no means a strong directive, something that must be followed imperatively. Quite the opposite, it's a way of presenting the reader with a solution and a set of ideas that they might find helpful.

As introduced at the beginning of the book, the goal of the book was not to give you recipes or formulas that you can apply directly, but rather to make you develop critical thinking. Idioms and syntax features come and go, they change over time. But ideas, and core software concepts, remain. With these tools given, and the examples provided, you should have a better understanding of what clean code means.

I sincerely hope the book has helped you become a better developer than you were before you started it, and I wish you the best of luck in your projects.

Other Books You May Enjoy

If you enjoyed this book, you may be interested in these other books by Packt:



Secret Recipes of the Python Ninja Cody Jackson

ISBN: 978-1-78829-487-4

- Know the differences between .py and .pyc files
- Explore the different ways to install and upgrade Python packages
- Understand the working of the PyPI module that enhances built-in decorators
- See how coroutines are different from generators and how they can simulate multithreading
- Grasp how the decimal module improves floating point numbers and their operations
- Standardize sub interpreters to improve concurrency
- Discover Python's built-in docstring analyzer

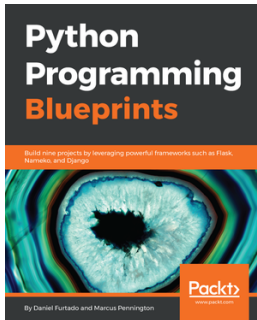

Python Programming Blueprints

Daniel Furtado, Marcus Pennington

ISBN: 978-1-78646-816-1

- Learn object-oriented and functional programming concepts while developing projects
- The dos and don'ts of storing passwords in a database
- Develop a fully functional website using the popular Django framework
- Use the Beautiful Soup library to perform web scrapping
- Get started with cloud computing by building microservice and serverless applications in AWS
- Develop scalable and cohesive microservices using the Nameko framework
- Create service dependencies for Redis and PostgreSQL

Leave a review - let other readers know what you think

Please share your thoughts on this book with others by leaving a review on the site that you bought it from. If you purchased the book from Amazon, please leave us an honest review on this book's Amazon page. This is vital so that other potential readers can see and use your unbiased opinion to make purchasing decisions, we can understand what our customers think about our products, and our authors can see your feedback on the title that they have worked with Packt to create. It will only take a few minutes of your time, but is valuable to other potential customers, our authors, and Packt. Thank you!

Index

A

- abstractions 288
- acronyms
 - about 72
 - DRY/OAOC 72
 - EAFP/LBYL 76
 - KISS 75
 - YAGNI 74
- analysis
 - dependency flow 304
 - intention revealing 306
 - limitations 305
 - testability 305
- annotations
 - about 13, 16
 - using, instead of docstrings 18
- Application Programming Interface (API) 56
- arguments
 - compact function signatures 92
 - copying, to functions 86
 - in functions 85, 91
 - in methods 85
 - passing, to Python 85
 - variable arguments 89
 - variable number 87
- asynchronous programming 215, 217
- automatic checks
 - setup 21

B

- basic quality gates
 - enforcing, by tools configuration 20
- behavioral patterns
 - about 270
 - chain of responsibility 270, 272
 - command pattern 273

- state pattern 274, 279
- template method 272
- best practices, software design
 - about 93
 - code, structuring 96
 - orthogonality in software 94
- Black
 - reference 22
- borg pattern
 - about 260
- builder pattern 262

C

- C3 linearization 84
- callable objects 48
- caveats, Python
 - about 49
 - built-in types, extending 51
 - mutable default arguments 50
- clean architecture
 - about 286
 - reference 307
- clean code
 - code formatting, role 9
 - coding style guide, adhering to 10
 - defining 8
 - importance 8
- code coverage
 - about 236
 - rest coverage, setting up 236
 - test coverage, caveats 237
- code dependency, consequences
 - low level of abstraction 71
 - no code reuse 71
 - ripple effects 71
- code duplication, limitations
 - error prone 72

- expensive 72
- unreliability 72
- code reuse
 - adapters 300
 - calling, from application 298
 - domain models 296
- code simplification, through iterators
 - about 197
 - nested loops 198
 - repeated iterations 198
- code
 - documenting 12
 - evolving 244
- cohesion 71
- composition 77
- considerations, descriptors
 - class decorators, avoiding 176, 179
 - code, reusing 175
- container iterable 43
- container objects 45
- context managers
 - about 29, 32
 - implementing 32, 35
- coroutines
 - about 203
 - advanced coroutines 209
 - data, receiving from sub-generator 213
 - data, sending to sub-generator 213
 - delegating, into smaller coroutines 210
 - generator interface, methods 204
 - value returned by sub-generator, returning 212
 - values, returning 209
 - yield form, use 211
- coupling 71
- creational patterns
 - about 256
 - borg pattern 260, 262
 - factories 256
 - shared state 257, 260
 - singleton 257

D

- data descriptors 163, 165
- decorate classes 127, 130
- decorate functions 126

- decorator objects 134
- decorators
 - analyzing 149
 - and separation of concerns 147
 - arguments, passing 131
 - code, tracing 136
 - common mistakes, avoiding 136
 - creating 143, 145
 - data, preserving about original wrapped object 136
 - descriptors, implementing 185
 - DRY principle, using with 146
 - incorrect handling of side-effects 139
 - qualities 149
 - side-effects, need for 141
 - types 131
 - uses 135
 - using, in Python 124
 - with nested functions 132
- defensive programming
 - about 60
 - assertions, using in Python 69
 - error handling 61
- dependency injection 122
- dependency inversion principle (DIP)
 - about 120, 289
 - dependencies, inverting 121
 - rigid dependencies 121
- descriptor, using in Python
 - built-in decorators, for methods 184
 - functions and methods 180
 - slots 185
- descriptors
 - global shared state, issue 172
 - about 152, 168
 - analysis 180
 - application 168
 - avoiding 168
 - considerations 175
 - data descriptors 165, 167
 - idiomatic implementation 169
 - implementing, forms 172
 - implementing, in decorators 185
 - machinery 153, 156
 - non-data descriptors 163, 165

- object dictionary, accessing 173
- types 163
- using, in Python 180
- weak references, using 174

design by contract scenario

- about 56
- conclusions 59
- invariants 57
- postconditions 57, 59
- preconditions 57, 58
- Pythonic contracts 59
- side-effects 57

design patterns

- about 282
- behavioral patterns 269
- considerations 254
- creational patterns 256
- influence 282
- structural patterns 262
- using 255
- using, in code 283

- docstrings 13, 16

- documentation 13

Don't Repeat Yourself (DRY) principle

- about 72
- using, with decorators 146, 236

- duck typing principle 117

E

- Easier to Ask Forgiveness than Permission (EAFP) 76

error handling

- about 61
- exception handling 62
- value substitution 61, 62

exception handling

- about 62
- at right level of abstraction 64, 65
- empty except blocks, avoiding 67
- original exception, exploring 69
- tracebacks exposure, avoiding 66

F

function arguments

- and coupling 91

- working, in Python 85

G

generators

- about 189, 191
- creating 189
- expressions 192
- references 218

- god-objects 100

H

Hexagonal Architecture

- reference 307

- hint 16

I

idioms for iteration

- about 193
- code, simplifying through iterators 197
- generator, using 196
- itertools 196
- next() function 195

- indexes 26

inheritance

- about 77
- anti-patterns 79, 81
- benefits 78

- interface 117

interface segregation principle (ISP)

- about 117
- guidelines 118, 119

iterable objects

- about 40
- creating 40, 43
- sequences, creating 43

iteration

- about 193
- idioms, using 193

iterator pattern

- in Python 200
- interface for iteration 200
- sequence objects, using as iterables 201

K

KIS (Keep It Simple) 75

L

Liskov's substitution principle (LSP)

- about 110
- issue detection, with tools 111
- reviews 116
- violation, cases 113

Look Before You Leap (LBYL) 76

LSP issues

- incompatible signatures, detecting with Pylint 113
- incorrect datatypes, detecting in method signatures with Mypy 112

M

magic methods 49

makefiles 21

methods, descriptor protocol

- `__delete__(self, instance)` 159
- `__set__(self, instance, value)` 158
- `__set_name__(self, owner, name)` 161
- about 156

methods, generator interface

- about 204
- `close()` method 204
- `send(value)` 206
- `throw(ex_type[, ex_value[, ex_traceback]])` 205

mock objects

- about 238
- using 239

mock

- about 239, 240
- types 240

multiple inheritance, Python

- Method Resolution Order (MRO) 82
- mixins 84

mutation testing 248

Mypy

- reference 20
- used, for detecting incorrect datatypes in method signatures 111
- used, for type hinting 20

N

name mangling 37

non-data descriptors 163

null object pattern 280

O

Object Relational Mapper SQLAlchemy (ORM
SQLAlchemy) 274

objects

- attributes 35
- dynamic attributes 46
- methods 35
- properties 35, 38, 39

Once and Only Once (OAOO) 72

open/closed principle (OCP)

- about 103, 109
- events system, extending 107
- events system, refactoring for extensibility 105
- maintainability perils example 103, 105

P

patching 239

PEP-8 characteristics

- code quality 12
- consistency 12
- grepability 11

Portable Operating System Interface (POSIX) 269

production code 246

property-based testing 248

Pylint

- used, for checking code 21
- used, for detecting incompatible signatures 113

pytest

- about 232
- fixtures 235
- parametrized tests 234
- used, for writing test cases 233

Python

- assertions, using 69
- caveats 49
- decorators, using 125
- descriptors, using 180
- design patterns, considerations 254
- iterator pattern 200

- multiple inheritance 82
- projects, reference 307
- underscores 35

R

- red-green-refactor cycle 251
- refactoring 244
- ripple effect 70

S

- Screaming Architecture
 - reference 307
- separation of concerns (SoC)
 - about 70, 287, 294
 - cohesion 71
 - coupling 71
- sequences
 - creating 28
- single responsibility principle (SRP)
 - about 99
 - class, with multiple responsibilities 100
 - responsibilities, distributing 102
- slices 26
- software components
 - containers 294
 - packages 290, 292
- software design
 - best practices 93
- structural patterns
 - about 263
 - adapter pattern 263
 - composite pattern 264
 - decorator pattern 266
 - facade pattern 268

T

- test doubles
 - use case 241
- test-driven development (TDD) 251
- testability 222
- testing 226
- testing boundaries
 - defining 225
- testing
 - tools 226

U

- unit testing
 - about 247
 - and agile software development 222
 - and software design 222
 - frameworks 226
 - libraries 226
 - mutation testing 248
 - property-based testing 248
 - pytest 232
 - unittest module 228
- unittest module
 - about 228
 - parametrized tests 230
- use case
 - about 295
 - analysis 304
 - code reuse 296
 - services 300, 303
- uses, decorators
 - parameters, transforming 135

W

- wrapped object 125

Y

- YAGNI (You Ain't Gonna Need It) 74